

# YASKAWA

## YASKAWA AC Drive V1000

### Compact Vector Control Drive

### Quick Start Guide

Type: CIMR-VC

Models: 200 V Class, Three-Phase Input: 0.1 to 18.5 kW

200 V Class, Single-Phase Input: 0.1 to 4.0 kW

400 V Class, Three-Phase Input: 0.37 to 18.5 kW

To properly use the product, read this manual thoroughly and retain for easy reference, inspection, and maintenance. Ensure the end user receives this manual.

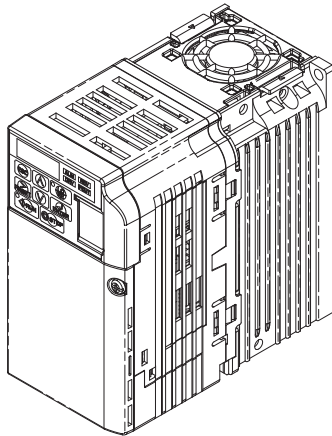

---

**Copyright © 2012**

**YASKAWA Electric Corporation.**

All rights reserved. No part of this publication may be reproduced, stored in a retrieval system, or transmitted, in any form, or by any means, mechanical, electronic, photocopying, recording, or otherwise, without the prior written permission of YASKAWA. No patent liability is assumed with respect to the use of the information contained herein. Moreover, because YASKAWA is constantly striving to improve its high-quality products, the information contained in this manual is subject to change without notice. Every precaution has been taken in the preparation of this manual. Nevertheless, YASKAWA assumes no responsibility for errors or omissions. Neither is any liability assumed for damages resulting from the use of the information contained in this publication

# V1000

## Quick Start Guide

---

<b>1</b>	<b>SAFETY INSTRUCTIONS AND GENERAL WARNINGS</b>	<b>4</b>
<b>2</b>	<b>MECHANICAL INSTALLATION</b>	<b>11</b>
<b>3</b>	<b>ELECTRICAL INSTALLATION</b>	<b>14</b>
<b>4</b>	<b>KEYPAD OPERATION</b>	<b>21</b>
<b>5</b>	<b>START UP</b>	<b>23</b>
<b>6</b>	<b>PARAMETER TABLE</b>	<b>28</b>
<b>7</b>	<b>TROUBLESHOOTING</b>	<b>33</b>
<b>8</b>	<b>INSTRUCTIONS FOR UL AND CUL</b>	<b>39</b>

# 1 Safety Instructions and General Warnings

YASKAWA Electric supplies component parts for use in a wide variety of industrial applications. The selection and application of YASKAWA products remain the responsibility of the equipment designer or end user. YASKAWA accepts no responsibility for the way its products are incorporated into the final system design. Under no circumstances should any YASKAWA product be incorporated into any product or design as the exclusive or sole safety control. Without exception, all controls should be designed to detect faults dynamically and fail safely under all circumstances. All products designed to incorporate a component part manufactured by YASKAWA must be supplied to the end user with appropriate warnings and instructions as to the safe use and operation of that part. Any warnings provided by YASKAWA must be promptly provided to the end user. YASKAWA offers an express warranty only as to the quality of its products in conforming to standards and specifications published in the manual. **NO OTHER WARRANTY, EXPRESS OR IMPLIED, IS OFFERED.** YASKAWA assumes no liability for any personal injury, property damage, losses, or claims arising from misapplication of its products.

### ◆ General Warnings

#### **WARNING**

- **Read and understand this manual before installing, operating or servicing this drive.**
- **All warnings, cautions, and instructions must be followed.**
- **All work must be performed by qualified personnel.**
- **The drive must be installed according to this manual and local codes.**
- **Heed the safety messages in this manual.**

The operating company is responsible for any injuries or equipment damage resulting from failure to heed the warnings in this manual.

The following conventions are used to indicate Safety messages in this manual:

#### **WARNING**

**Indicates a hazardous situation, which, if not avoided, could result in death or serious injury.**

## CAUTION

Indicates a hazardous situation, which, if not avoided, could result in minor or moderate injury.

## NOTICE

Indicates a property damage message.

### Safety Warnings

## WARNING

### Electrical Shock Hazard

**Do not attempt to modify or alter the drive in any way not explained in this manual.**

Failure to comply could result in death or serious injury.

YASKAWA is not responsible for any modification of the product made by the user. This product must not be modified.

**Do not touch any terminals before the capacitors have fully discharged.**

Failure to comply could result in death or serious injury.

Before wiring terminals, disconnect all power to the equipment. The internal capacitor remains charged even after the power supply is turned off. The charge indicator LED will extinguish when the DC bus voltage is below 50 Vdc. To prevent electric shock, wait at least five minutes after all indicators are off and measure the DC bus voltage level to confirm safe level.

**Do not allow unqualified personnel to use equipment.**

Failure to comply could result in death or serious injury.

Maintenance, inspection, and replacement of parts must be performed only by authorized personnel familiar with installation, adjustment, and maintenance of AC drives.

# 1 Safety Instructions and General Warnings

## WARNING

**Do not remove covers or touch circuit boards while the power is on.**

Failure to comply could result in death or serious injury.

**Make sure the protective earthing conductor complies with technical standards and local safety regulations.**

The leakage current of this drive exceeds 3.5 mA. Therefore, according to IEC/EN 61800-5-1, automatic power supply interruption in case of discontinuity of the protective earthing conductor must be provided or a protective earthing conductor with a cross section of at least 10 mm<sup>2</sup> (Cu) or 16 mm<sup>2</sup> (Al) must be used.

**Use appropriate equipment for residual current monitoring/detection (RCM/RCD).**

This drive can cause a residual current with a DC component in the protective earthing conductor. Where a residual current operated protective or monitoring device is used for protection in case of direct or indirect contact, always use an RCM or RCD of type B according to IEC/EN 60755.

**Always ground the motor-side grounding terminal.**

Improper equipment grounding could result in death or serious injury by contacting the motor case.

**Do not perform work on the drive while wearing loose clothing, jewelry or without eye protection.**

Failure to comply could result in death or serious injury.

Remove all metal objects such as watches and rings, secure loose clothing, and wear eye protection before beginning work on the drive.

**Never short the output circuits of the drive.**

Do not short the output circuits of the drive. Failure to comply could result in death or serious injury.

## WARNING

### **Sudden Movement Hazard**

**Stay clear of the motor during rotational Auto-Tuning. The motor may start operating suddenly.**

During automatic starting of equipment, the machine may start moving suddenly, which could result in death or serious injury.

**System may start unexpectedly upon application of power, resulting in death or serious injury.**

Clear all personnel from the drive, motor, and machine area before applying power. Secure covers, couplings, shaft keys, and machine loads before applying power to the drive.

### **Fire Hazard**

**Do not use an improper voltage source.**

Failure to comply could result in death or serious injury by fire.

Verify that the rated voltage of the drive matches the voltage of the incoming power supply before applying power.

**Do not use improper combustible materials.**

Failure to comply could result in death or serious injury by fire.

Attach the drive to metal or other noncombustible material.

**Do not connect AC line power to output terminals U, V, and W.**

**Make sure that the power supply lines are connected to main circuit input terminals R/L1, S/L2, T/L3 (or R/L1 and S/L2 for single-phase drives).**

Do not connect the AC power line to the output motor terminals of the drive. Failure to comply could result in death or serious injury by fire as a result of drive damage from line voltage application to output terminals.

**Tighten all terminal screws to the specified tightening torque.**

Loose electrical connections could result in death or serious injury by fire due to overheating of electrical connections.

## 1 Safety Instructions and General Warnings

---

### CAUTION

#### **Crush Hazard**

**Do not carry the drive by the front cover.**

Failure to comply may result in minor or moderate injury from the main body of the drive falling.

#### **Burn Hazard**

**Do not touch the heatsink or braking resistor hardware until a powered-down cooling period has elapsed.**

### NOTICE

#### **Equipment Hazard**

**Observe proper electrostatic discharge procedures (ESD) when handling the drive and circuit boards.**

Failure to comply may result in ESD damage to the drive circuitry.

**Never connect or disconnect the motor from the drive while the drive is outputting voltage.**

Improper equipment sequencing could result in damage to the drive.

**Do not perform a withstand voltage test on any part of the drive.**

Failure to comply could result in damage to the sensitive devices within the drive.

**Do not operate damaged equipment.**

Failure to comply could result in further damage to the equipment.

Do not connect or operate any equipment with visible damage or missing parts.

**Install adequate branch circuit short circuit protection per applicable codes.**

Failure to comply could result in damage to the drive.

The drive is suitable for circuits capable of delivering not more than 100,000 RMS symmetrical Amperes, 240 Vac maximum (200 V Class) and 480 Vac maximum (400 V Class).



## NOTICE

**Do not use unshielded cable for control wiring.**

Failure to comply may cause electrical interference resulting in poor system performance.

Use shielded twisted-pair wires and ground the shield to the ground terminal of the drive.

**Do not allow unqualified personnel to use the product.**

Failure to comply could result in damage to the drive or braking circuit.

Carefully review the braking option instruction manual when connecting a braking option to the drive.

**Do not modify the drive circuitry.**

Failure to comply could result in damage to the drive and will void warranty.

YASKAWA is not responsible for modification of the product made by the user. This product must not be modified.

**Check all the wiring to ensure that all connections are correct after installing the drive and connecting other devices.**

Failure to comply could result in damage to the drive.

**Do not connect unapproved LC or RC interference suppression filters, capacitors, or overvoltage protection devices to the output of the drive.**

Using unapproved filters could result in damage to the drive or motor equipment.

### ◆ Precautions for CE Low Voltage Directive Compliance

This drive has been tested according to European standard IEC/EN 61800-5-1, and it fully complies with the Low Voltage Directive. The following conditions must be met to maintain compliance when combining this drive with other devices:

Do not use drives in areas with pollution higher than severity 2 and overvoltage category 3 in accordance with IEC/EN 664.

Ground the neutral point of the main power supply for 400 V Class drives.

# 1 Safety Instructions and General Warnings

---

## ◆ Precautions for UL/cUL Standards Compliance

This drive is tested in accordance with UL standard UL508C and complies with UL requirements.

---

## ◆ Precautions for Using the Safe Disable Function

The Safe Disable function can be utilized to perform a safe stop according to the IEC/EN 61800-5-2, stop category 0 (Uncontrolled stop by power removal). It is designed to meet the requirements of the ISO/EN 13849-1, Safety Category 3, PL d, and IEC/EN 61508, SIL2. Refer to the Technical Manual for details about the application of this function.

## 2 Mechanical Installation

### ◆ Upon Receipt

Please perform the following tasks after receiving the drive:

- Inspect the drive for damage. If the drive appears damaged upon receipt, contact your supplier.
- Verify receipt of the correct model by checking the information on the nameplate. If you have received the wrong model contact your supplier.

### ◆ Installation Environment

For optimum performance life of the drive, install the drive in an environment that meets the conditions listed below.

Environment	Conditions
Installation Area	Indoors
Ambient Temperature	IP20/NEMA Type1 enclosure: -10 to +40°C IP20/IP00 Open-Chassis enclosure: -10 to +50°C Finless Type: IP20/IP00 enclosure: -10 to +50°C NEMA Type4X/IP66 enclosure: -10 to +40°C When using an enclosure panel, install a cooling fan or air conditioner in the area to ensure that the air temperature inside the enclosure does not exceed the specified levels. Do not allow ice to develop on the drive.
Humidity	95% RH or less and free of condensation
Storage Temperature	-20°C to +60°C
Surrounding Area	Install the drive in an area free from: <ul style="list-style-type: none"> <li>• oil mist and dust</li> <li>• metal shavings, oil, water or other foreign materials</li> <li>• radioactive materials</li> <li>• combustible materials (e.g., wood)</li> <li>• harmful gases and liquids</li> <li>• excessive vibration</li> <li>• chlorides</li> <li>• direct sunlight</li> </ul>
Altitude	1000 m or less
Vibration	10 to 20 Hz at 9.8 m/s <sup>2</sup> , 20 to 55 Hz at 5.9 m/s <sup>2</sup>
Orientation	Install the drive vertically to maintain maximum cooling effects.

## 2 Mechanical Installation

### ◆ Installation Orientation and Spacing

Always install the drive in an upright position.  
Leave space around the unit for proper cooling as shown in the figure on the right.

**Note:** Several units can be installed closer together than shown in the figure by using "Side-by-Side" mounting.  
For details please refer to the Technical Manual.

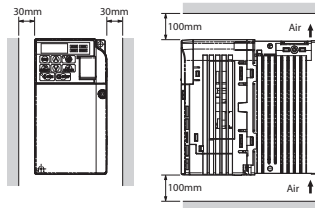

### ◆ Dimensions

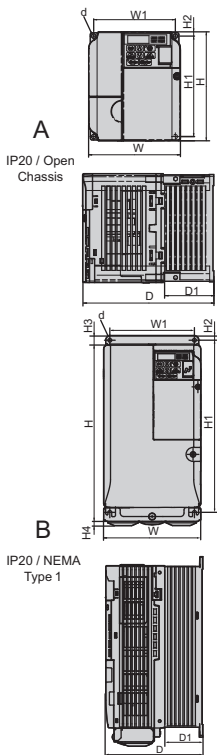

Model CIMR-V□	Dimensions (mm)											Weight (kg)
	Fig.	W	H	D	W1	H1	H2	H3	H4	D1	d	
BA0001B	A	68	128	76	56	118	5	-	-	6.5	M4	0.6
BA0002B		68	128	76	56	118	5	-	-	6.5	M4	0.6
BA0003B		68	128	118	56	118	5	-	-	38.5	M4	1.0
BA0006B		108	128	137.5	96	118	5	-	-	58	M4	1.7
BA0010B		108	128	154	96	118	5	-	-	58	M4	1.8
BA0012B		140	128	163	128	118	5	-	-	65	M4	2.4
BA0018B		170	128	180	158	118	5	-	-	65	M4	3.0
2A0001B		68	128	76	56	118	5	-	-	6.5	M4	0.6
2A0002B		68	128	76	56	118	5	-	-	6.5	M4	0.6
2A0004B		68	128	108	56	118	5	-	-	38.5	M4	0.9
2A0006B		68	128	128	56	118	5	-	-	38.5	M4	1.1
2A0010B		108	128	129	96	118	5	-	-	58	M4	1.7
2A0012B		108	128	137.5	96	118	5	-	-	58	M4	1.7
2A0020B		140	128	143	128	118	5	-	-	65	M4	2.4
2A0030F		140	254	140	122	248	6	13	6.2	55	M5	3.8
2A0040F		140	254	140	122	248	6	13	6.2	55	M5	3.8
2A0056F		180	290	163	160	284	8	15	6.2	75	M5	5.5
2A0069F		220	350	187	192	336	7	15	7.2	78	M6	9.2
4A0001B	A	108	128	81	96	118	5	-	-	10	M4	1.0
4A0002B		108	128	99	96	118	5	-	-	28	M4	1.2
4A0004B		108	128	137.5	96	118	5	-	-	58	M4	1.7
4A0005B		108	128	154	96	118	5	-	-	58	M4	1.7
4A0007B		108	128	154	96	118	5	-	-	58	M4	1.7
4A0009B		108	128	154	96	118	5	-	-	58	M4	1.7
4A0011B		140	128	143	128	118	5	-	-	65	M4	2.4
4A0018F		140	254	140	122	248	6	13	6	55	M5	3.8
4A0023F		140	254	140	122	248	6	13	6.2	55	M5	3.8
4A0031F		180	290	143	160	284	8	15	6	55	M5	5.2
4A0038F		180	290	163	160	284	8	15	6	75	M5	5.5
		B										

## 2 Mechanical Installation

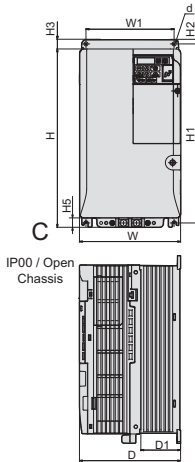

Model CIMR-V□	Dimensions (mm)											Weight (kg)
	Fig.	W	H	D	W1	H1	H2	H3	H4	D1	d	
2A0030A	C	140	247	140	122	248	6	13	13	55	M5	3.6
2A0040A		140	247	140	122	248	6	13	13	55	M5	3.6
2A0056A		180	285	163	160	284	8	15	15	75	M5	5.3
2A0069A		220	335	187	192	336	7	15	15	78	M6	8.7
4A0018A		140	247	140	122	248	6	13	13	55	M5	3.6
4A0023A		140	247	140	122	248	6	13	13	55	M5	3.6
4A0031A		180	285	143	160	284	8	15	15	55	M5	5.0
4A0038A		180	285	163	160	284	8	15	15	75	M5	5.3

# 3 Electrical Installation

The figure below shows the main and control circuit wiring.

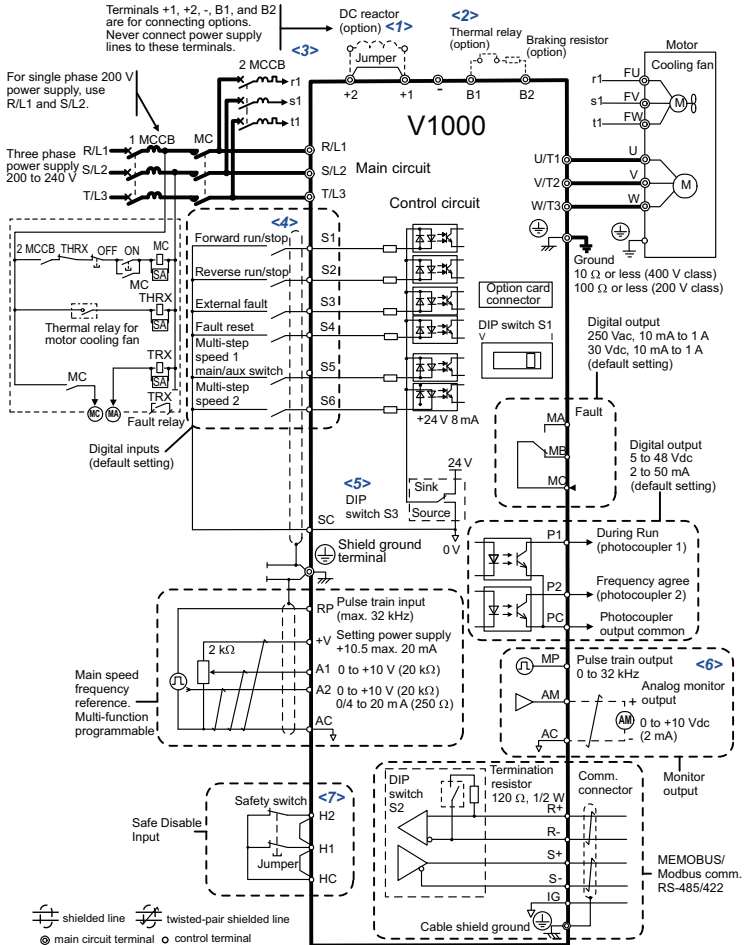

Figure 1 Drive Standard Connection Diagram

- <1> Remove the jumper when installing an optional DC reactor.
- <2> The MC on the input side of the main circuit should open when the thermal relay is triggered.
- <3> Self-cooled motors do not require separate cooling fan motor wiring.
- <4> Connected using sequence input signal (S1 to S6) from NPN transistor; Default: sink mode (0 V com).
- <5> Use only a +24 V internal power supply in sinking mode; the source mode requires an external power supply.
- <6> Monitor outputs work with devices such as analog frequency meters, ammeters, voltmeters and wattmeters; they are not intended for use as a feedback-type of signal.
- <7> Disconnect the wire jumper between HC, H1, and H2 when utilizing the safety input. The wire length for the Safe Disable input should not exceed 30 m.
- <8> Note that if the drive is set to trigger a fault output whenever the fault restart function is activated (L5-02 = 1), then a sequence to interrupt power when a fault occurs will result in shutting off the power to the drive as the drive attempts to restart itself. The default setting for L5-02 is 0 (fault output active during restart attempt).

### ◆ Wiring Specification

#### ■ Main Circuit

Use the line filters listed in the table below when wiring the main circuit.

Model CIMR-V□	EMC Filter Type	Recomm. Motor cable [mm <sup>2</sup> ]	Main Circuit Terminal Sizes		
	Schaffner		R/L1, S/L2, T/L3, U/T1, V/T2, W/T3, -, +1, +2	B1, B2	GND
BA0001	FS23638-10-07	2.5	M3.5	M3.5	M3.5
BA0002	FS23638-10-07	2.5	M3.5	M3.5	M3.5
BA0003	FS23638-10-07	2.5	M3.5	M3.5	M3.5
BA0006	FS23638-20-07	2.5	M4	M4	M4
BA0010	FS23638-20-07	2.5	M4	M4	M4
BA0012	FS23638-30-07	2.5	M4	M4	M4
BA0018	FS23638-40-07	2.5	M5	M5	M5
2A0001	FS23637-8-07	2.5	M3.5	M3.5	M3.5
2A0002	FS23637-8-07	2.5	M3.5	M3.5	M3.5
2A0004	FS23637-8-07	2.5	M3.5	M3.5	M3.5
2A0006	FS23637-8-07	2.5	M3.5	M3.5	M3.5
2A0010	FS23637-14-07	2.5	M4	M4	M4
2A0012	FS23637-14-07	2.5	M4	M4	M4
2A0020	FS23637-24-07	2.5	M4	M4	M4
2A0030	FS23637-52-07	6	M4	M4	M5
2A0040	FS23637-52-07	10	M4	M4	M5
2A0056	FS23637-68-07	16	M6	M5	M6
2A0069	FS23637-80-07	16	M8	M5	M6
4A0001	FS23639-5-07	2.5	M4	M4	M4
4A0002	FS23639-5-07	2.5	M4	M4	M4
4A0004	FS23639-5-07	2.5	M4	M4	M4
4A0005	FS23639-10-07	2.5	M4	M4	M4
4A0007	FS23639-10-07	2.5	M4	M4	M4
4A0009	FS23639-10-07	2.5	M4	M4	M4
4A0011	FS23639-15-07	2.5	M4	M4	M4

### 3 Electrical Installation

Model CIMR-V□	EMC Filter Type	Recomm. Motor cable [mm <sup>2</sup> ]	Main Circuit Terminal Sizes		
	Schaffner		R/L1, S/L2, T/L3, U/T1, V/T2, W/T3, -, +1, +2	B1, B2	GND
4A0018	FS23639-30-07	2.5	M4	M4	M5
4A0023	FS23639-30-07	4	M4	M4	M5
4A0031	FS23639-50-07	6	M5	M5	M6
4A0038	FS23639-50-07	6	M5	M5	M6

#### Input Fuse Selection

Use the fuses listed in the table on [page 40](#) when wiring the main circuit.

#### ■ Control Circuit

The control terminal board is equipped with screwless terminals. Always use wires within the specification listed below. For safe wiring it is recommended to use solid wires or flexible wires with ferrules. The stripping length respectively ferrule length should be 8 mm.

Wire Type	Wire size (mm <sup>2</sup> )
Solid	0.2 to 1.5
Flexible	0.2 to 1.0
Flexible with ferrule	0.25 to 0.5

#### ◆ EMC Filter Installation

This drive has been tested in accordance with European standards IEC/EN 61800-3. In order to comply to the EMC standards, wire the main circuit as described below.

1. Install an appropriate EMC noise filter to the input side. See the list above or refer to the Technical Manual for details.
2. Place the drive and EMC noise filter in the same enclosure.
3. Use braided shield cable for the drive and motor wiring
4. Remove any paint or dirt from ground connections for minimal ground impedance
5. Install an AC reactor at drives smaller than 1 kW for compliance with the IEC/EN 61000-3-2. Refer to the Technical Manual or contact your supplier for details



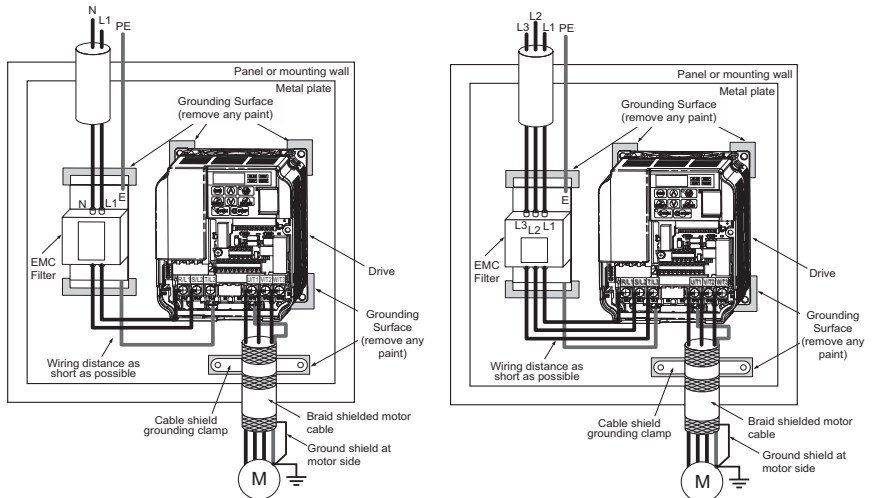

Figure 2 EMC Standards Compliant Wiring of Single and Three Phase Units

### ◆ Main and Control Circuit Wiring

#### ■ Wiring the Main Circuit Input

Consider the following precautions for the main circuit input.

- Use fuses recommended in Main Circuit on [page 15](#) only.
- When using residual current monitoring or detection devices (RCM/RCD), make sure the devices are designed for use with AC drives (e.g. type B according to IEC/EN 60755).
- If using a ground fault circuit breaker, make sure that it can detect both DC and high frequency current.
- Use a DC reactor or AC reactor on the input side of the drive:
  - To suppress harmonic current.
  - To improve the power factor on the power supply side.
  - When using an advancing capacitor switch.
  - With a large capacity power supply transistor (over 600 kVA).

#### ■ Wiring the Main Circuit Output

Consider the following precautions for the output circuit wiring.

- Do not connect any other load than a 3 phase motor to the drives output.
- Never connect a power source to the drives output.

### 3 Electrical Installation

---

- Never short or ground the output terminals.
- Do not use phase correction capacitors.
- If using a contactor between the drive and motor, it should never be operated when the drive is outputting a voltage. Operating while there is voltage output can cause large peak currents, thus tripping the over current detection or damage the drive.

#### ■ Ground Connection

Take the following precautions when grounding the drive.

- The drive must always be connected to ground in accordance to the general technical standards and local regulations.  
As the leakage current produced by the drive exceeds 3.5 mA, according to IEC/EN 61800-5-1, at least one of the conditions below must be satisfied:
  - The cross-section of the protective earthing conductor must be at least 10 mm<sup>2</sup> (Cu) or 16 mm<sup>2</sup> (Al).
  - The power supply must be disconnected automatically in case of discontinuity of the protective earthing conductor.
- Keep ground wires as short as possible.
- Always make sure the ground impedance is conformed to the requirements of local safety and installation regulations.
- Never share the ground wire with other devices such as welding machines, etc.
- Do not loop the ground wire when using more than one drive.

#### ■ Control Circuit Wiring Precautions

Consider the following precautions for wiring the control circuits.

- Separate control circuit wiring from main circuit wiring and other high-power lines.
- Separate wiring for control circuit terminals MA, MB, MC (contact output) from wiring to other control circuit terminals.
- For external control power supply use a UL Listed Class 2 power supply.
- Use twisted-pair or shielded twisted-pair cables for control circuits to prevent operating faults.
- Ground the cable shields with the maximum contact area of the shield and ground.
- Cable shields should be grounded on both cable ends.
- If flexible wires with ferrules are connected they might fit tightly into the terminals. To disconnect them, grasp the wire end with a pair of pliers, release the terminal using a straight-edge screw driver, turn the wire for about 45°, and pull it gently out of the terminal. For details, refer to the Technical Manual. Use this procedure for removing the wire link between HC, H1 and H2 when the Safe Disable function is utilized.

#### ■ Main Circuit Terminals

Terminal	Type	Function
R/L1, S/L2, T/L3	Main circuit power supply input	Connects line power to the drive. Drives with single-phase 200 V input power use terminals R/L1 and S/L2 only (T/L3 is not used).

Terminal	Type	Function
U/T1, V/T2, W/T3	Drive output	Connects to the motor.
B1, B2	Braking resistor	For connecting a braking resistor or the braking resistor unit option.
+1, +2	DC reactor connection	Linked at shipment. Remove the link to install a DC choke.
+1, -	DC power supply input	For connecting a DC power supply.
 (2 terminals)	Ground Terminal	For 200 V class: Ground with 100 Ω or less For 400 V class: Ground with 10 Ω or less

#### ■ Control Circuit Terminals

The figure below shows the control circuit terminal arrangement. The drive is equipped with screwless terminals.

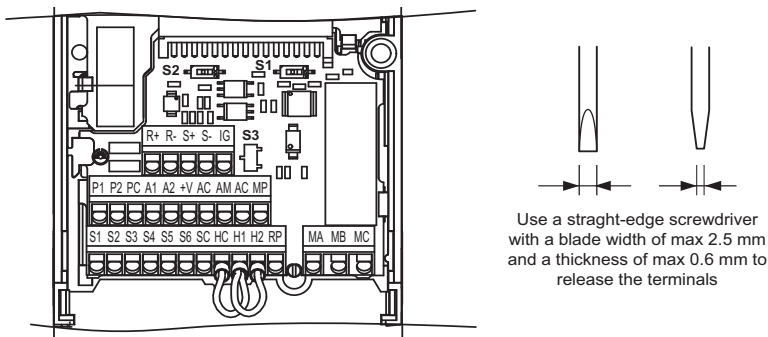

There are three DIP switches, S1 to S3, located on the terminal board.

<b>SW1</b>	Switches analog input A2 between voltage and current input.
<b>SW2</b>	Enables or disables the internal RS422/485 comm. port terminal resistance.
<b>SW3</b>	Used to select sourcing (PNP)/sinking (NPN, default) mode for the digital inputs (PNP requires external 24 Vdc power supply).

## 3 Electrical Installation

### ■ Control Circuit Terminal Functions

Type	No.	Terminal Name (Signal)	Function (Signal Level), Default Setting
Multi-Function Digital Inputs	S1 to S6	Multi-function digital input 1 to 6	Photocoupler inputs, 24 Vdc, 8 mA Note: Drive preset to sinking mode (NPN). When using source mode, set DIP switch S3 to "SOURCE" and use an external 24 Vdc ( $\pm 10\%$ ) power supply.
	SC	Multi-function input common	Sequence common
Multi-Function Analog/Pulse Inputs	RP	Pulse train input	Response frequency: 0.5 to 32 kHz, Duty: 30 to 70%, High: 3.5 to 13.2 V, Low: 0.0 to 0.8 V, input impedance: 3 k $\Omega$ )
	+V	Analog input power supply	+10.5 V (max allowable current 20 mA)
	A1	Multi-function analog input 1	0 to +10 Vdc (20 k $\Omega$ ) resolution 1/1000
	A2	Multi-function analog input 2	0/4 to 20 mA (250 $\Omega$ ) resolution: 1/500 (A2 only)
Safe Disable Inputs	AC	Frequency reference common	0 V
	HC	Safe Disable Input common	+24 V (max 10 mA allowed)
	H1 H2	Safe Disable Input 1 Safe Disable Input 2	One or both open: Drive output disabled (time from input open to drive output switch off is less than 1 ms) Both Closed: Normal operation
Multi-Function Relay Output	MA	N.O. (fault)	Digital relay output 30 Vdc, 10 mA to 1 A 250 Vac, 10 mA to 1 A
	MB	N.C. output (fault)	
	MC	Digital output common	
Multi-Function PHC Output	P1	Photocoupler output 1	Digital photocoupler output 48 Vdc, 2 to 50 mA
	P2	Photocoupler output 2	
	PC	Photocoupler output common	
Monitor Output	MP	Pulse train output	32 kHz (max)
	AM	Analog monitor output	0 to 10 Vdc (2 mA or less), Resolution: 1/1000 (10 bit)
	AC	Monitor common	0 V
MEMO-BUS/Communication	R+	Communications input (+)	MEMOBUS/Modbus communication.: RS-485 or RS-422, 115.2 kbps (max)
	R-	Communications input (-)	
	S+	Communications output (+)	
	S-	Communications output (-)	

**NOTICE:** The terminals HC, H1, H2 are used for the Safe Disable function which cuts the output voltage in less than 1 ms if at least one of the inputs H1 or H2 is opened. It is designed in accordance with the ISO/EN 13849-1, Safety Category 3, PL d, and IEC/EN 61508, SIL2. It can be utilized to perform a safe stop as defined by the IEC/EN 61800-5-2, stop category 0. Do not remove the wire link between HC, H1, or H2 unless the Safe Disable function is used. Refer to the Technical Manual when using this function.

**NOTICE:** The wiring length to the terminals HC, H1 and H2 should not exceed 30 m.

## 4 Keypad Operation

### ◆ LED Operator and Keys

The LED operator is used to program the drive, to start/stop it, and to display fault information. The LEDs indicate the drive status.



### ■ Keys and Functions

Display	Name	Function
	Data Display Area	Displays the frequency reference, parameter number, etc.
	ESC Key	Returns to the previous menu.
	RESET Key	Moves the cursor to the right. Resets a fault.
	RUN Key	Starts the drive in the LOCAL mode. The Run LED <ul style="list-style-type: none"> <li>• is on, when the drive is operating the motor.</li> <li>• flashes during deceleration to stop or when the frequency reference is 0.</li> <li>• flashes quickly the drive is disabled by a DI, the drive was stopped using a fast stop DI or a run command was active during power up.</li> </ul>
	Up Arrow Key	Scrolls up to select parameter numbers, setting values, etc.
	Down Arrow Key	Scrolls down to select parameter numbers, setting values, etc.
	STOP Key	Stops the drive.
	ENTER Key	Selects modes, parameters and is used to store settings.
	LO/RE Selection Key	Switches drive control between the operator (LOCAL) and the control circuit terminals (REMOTE). The LED is on when the drive is in the LOCAL mode (operation from keypad).
	ALM LED Light	Flashing: The drive is in an alarm state. On: The drive is in a fault state and the output is stopped.
	REV LED Light	On: The motor rotation direction is reverse. Off: The motor rotation direction is forward.
	DRV LED Light	On: The drive is ready to operate the motor. Off: The drive is in the Verify, Setup, Parameter Setting or Auto tuning mode.
	FOUT LED Light	On: The output frequency is displayed on the data screen. Off: Anything else than the output frequency is displayed on the data screen.

## 4 Keypad Operation

### ◆ Menu Structure and Modes

The following illustration explains the operator keypad menu structure.

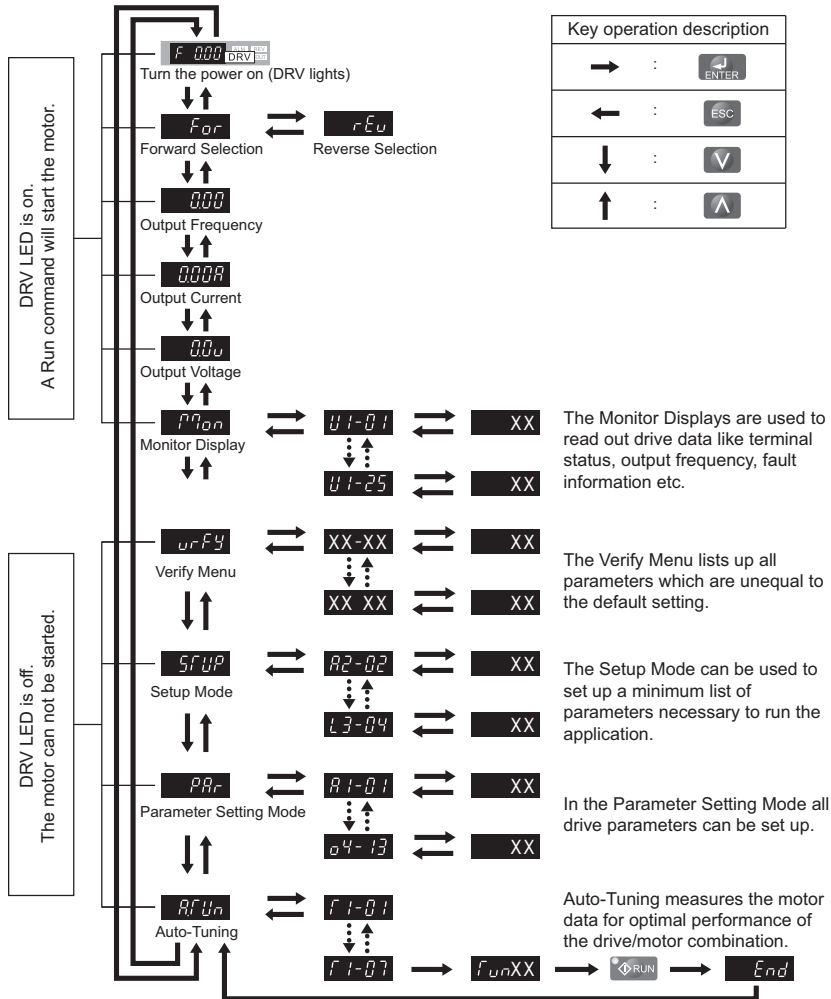

## 5 Start Up

### ◆ Drive Setup Procedure

The illustration below shows the basic setup procedure. Each step is explained more detailed on the following pages.

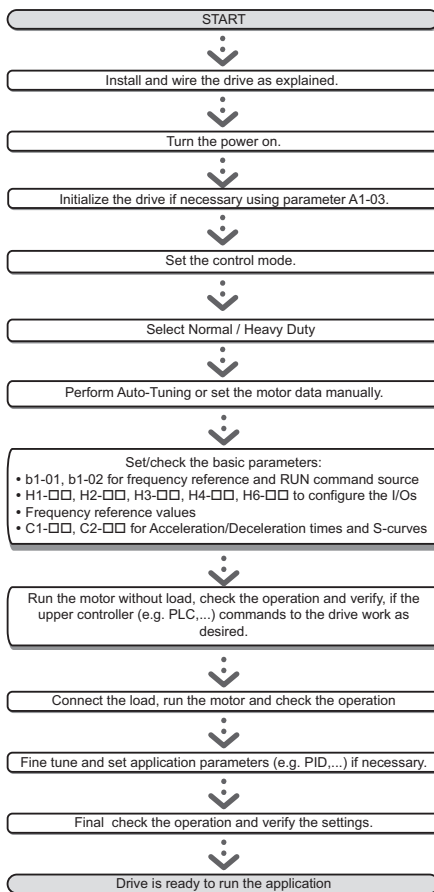

## 5 Start Up

### ◆ Power On

Before turning on the power supply,

- Make sure all wires are connected properly.
- Make sure no screws, loose wire ends or tools are left in the drive.
- After turning the power on, the drive mode display should appear and no fault or alarm should be displayed.

### ◆ Control Method Selection (A1-02)

There are three control modes available. Select the control mode that best suits the application the drive will control.

Control Mode	Parameter	Main Applications
V/f Control	A1-02 = 0 (default)	<ul style="list-style-type: none"><li>• General variable speed applications, particularly useful for running multiple motors from a single drive</li><li>• When replacing a drive in which parameter settings are unknown</li></ul>
Open Loop Vector Control (OLV)	A1-02 = 2	<ul style="list-style-type: none"><li>• General variable speed applications</li><li>• Applications requiring high precision, high speed control</li></ul>
PM Open Loop Vector Control	A1-02 = 5	<ul style="list-style-type: none"><li>• Derated torque-load applications employing permanent magnet motors (SPM, IPM) and energy savings.</li></ul>

### ◆ Normal / Heavy Duty Selection (C6-01)

The drive supports two ratings, Normal Duty and Heavy Duty. Both have different output current ratings (refer to the catalog or Technical Manual). Set the Duty mode in accordance with the application.

Mode	Heavy Duty Rating (HD)	Normal Duty Rating (ND)
C6-01	0	1
Application	Applications with a constant torque like extruders, conveyors and cranes. High overload capability might be needed.	Applications where the torque increases with the speed like fans or pumps. High overload tolerance is normally not needed.
Overload capability (oL2)	150% of drive rated current for 60 s	120% of drive rated current for 60 s
L3-02 Stall Prevention during Acceleration	150%	120%
L3-06 Stall Prevention during Run	150%	120%
Default carrier frequency	8 kHz	Swing PWM



## ◆ Auto-Tuning (T1-□□)

Auto-Tuning automatically sets up the motor data relevant drive parameters. Three different modes are supported.

Tuning Mode	Parameter	Control Mode	Description
Rotational Auto-Tuning	T1-01 = 0	OLV	Perform when setting the drive to operate in Open Loop Vector control. The motor must be able to rotate without load during the tuning process in order to achieve a high accuracy.
Terminal resistance tuning	T1-01 = 2	OLV, V/f control	Perform in V/f control if the motor cable is long or if the cable has been changed.
Rotational Auto-Tuning for Energy Saving	T1-01 = 3	V/f control	Perform when using Energy Saving or Speed Search. The motor must be able to rotate without load in order to achieve a high tuning accuracy.

### ⚠ CAUTION

**Never touch the motor until the Auto-Tuning is finished.**

Even though the motor may not be rotating when Auto-Tuning, voltage is still applied to the motor during the tuning process.

For Auto-Tuning enter the Auto-Tuning menu and perform the steps shown in the figure below. The number of name plate data to be entered depends on the selected type of Auto-Tuning. This example shows Rotational Auto-Tuning.

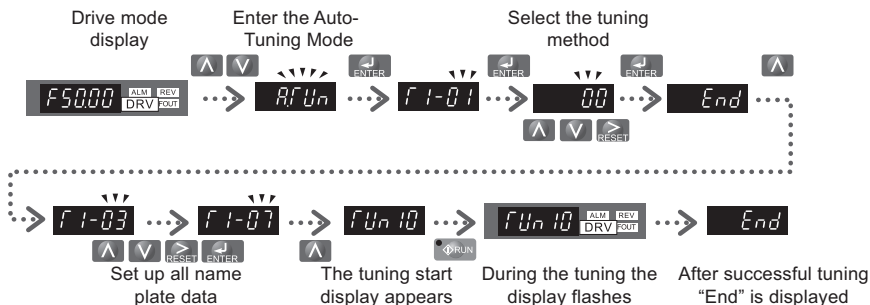

## 5 Start Up

---

If Auto-Tuning can not be performed for some reason (no-load operation impossible etc.), then set up the maximum frequency and voltage in the E1-□□ parameters and enter the motor data manually into the E2-□□ parameters.

**NOTICE:** *The Safe Disable inputs must be closed during Auto-Tuning.*

---

### ◆ Reference and Run Source

The drive has a LOCAL and a REMOTE mode.

Status	Description
LOCAL	The Run/ Stop command and the frequency reference are entered at the operator keypad.
REMOTE	The Run command source entered in parameter b1-02 and the frequency reference source entered in parameter b1-01 are used.

If the drive is operated in the REMOTE mode, make sure that the correct sources for the frequency reference and run command are set in parameters b1-01/02 and that the drive is in the REMOTE mode.

The LED in the LO/RE key indicates where the Run command is input from.

LO/RE LED	Description
ON	Run command is issued from operator.
OFF	Run command is issued from a different source than the operator.

---

### ◆ I/O Setup

#### ■ Multi-Function Digital Inputs (H1-□□)

The function of each digital input can be assigned in the H1-□□ parameters. The default setting functions can be seen in the connection diagram on [page 14](#).

#### ■ Multi-Function Digital Outputs (H2-□□)

The function of each digital output can be assigned in the H2-□□ parameters. The default setting functions can be seen in the connection diagram on [page 14](#). The setting value of these parameters consist of 3 digits, where the middle and right digit set the function and the left digit sets the output characteristics (0: Output as selected; 1: Inverse output).

#### ■ Multi-Function Analog Inputs (H3-□□)

The function of each analog input can be assigned in the H3-□□ parameters. The default setting of both inputs is “Frequency bias”. Input A1 is set for 0 to 10 V input and A2 is set for 4-20 mA input. The addition of both input values builds the frequency reference.

**NOTICE:** If the input signal level of input A2 is switched between voltage and current, make sure that DIP switch S1 is in the correct position and parameter H3-09 is set up correctly.

### ■ Monitor Output (H4-□□)

Use the H4-□□ parameters to set up the output value of the analog monitor output and to adjust the output voltage levels. The default monitor value setting is “Output frequency”.

## ◆ Frequency Reference and Acceleration/ Deceleration Times

### ■ Frequency Reference Setup (b1-01)

Set parameter b1-01 according to the frequency reference used.

b1-01	Reference source	Frequency reference input
0	Operator keypad	Set the frequency references in the d1-□□ parameters and used digital inputs to switch over between different reference values.
1	Analog input	Apply the frequency reference signal to terminal A1 or A2.
2	Serial Comm.	Serial Communications using the RS422/485 port
3	Option Board	Communications option card
4	Pulse input	Set the frequency reference at terminal RP using a pulse train signal.

### ■ Acceleration/ Deceleration Times and S-Curves

There are four sets of acceleration and deceleration times which can be set in the C1-□□ parameters. The default activated accel/decel times are C1-01/02. Adjust these times to the appropriate values required by the application. If necessary S-curves can be activated in the C2-□□ parameters for softer accel/decel start and end.

## ◆ Test Run

Perform the following steps to start up the machine after all parameter settings have been done.

1. Run the motor without load and check if all input, outputs and the sequence work as desired.
2. Connect the load to the motor.
3. Run the motor with load and make sure that there is no vibrations, hunting or motor stalling occurs.

After taking the steps listed above, the drive should be ready to run the application and perform the basic functions. For special setups like PID control etc. refer to the Technical Manual.

# 6 Parameter Table

This parameter table shows the most important parameters. Default settings are in bold type. Refer to the Technical Manual for a complete list of parameters.

Par.	Name	Description
<b>Initialization Parameters</b>		
A1-01	Access Level Selection	Selects which parameters are accessible via the digital operator. 0: Operation only 1: User Parameters <b>2: Advanced Access Level</b>
A1-02	Control Method Selection	Selects the Control Method of the drive. <b>0: V/f Control</b> 2: Open Loop Vector (OLV) 5: PM Open Loop Vector (PM) Note: Not initialized with A1-03!
A1-03	Initialize Parameters	Resets all parameters to default. (returns to 0 after initialization) 0: No Initialization 1110: User Initialize (The user must first set user parameter values and then store them using parameter o2-03) 2220: 2-Wire Initialization 3330: 3-Wire Initialization
<b>Operation Mode Selection</b>		
b1-01	Frequency Reference Selection	0: Digital Operator - d1 - □□ values <b>1: Analog input A1 or A2</b> 2: Serial Com - RS-422/485 3: Option board 4: Pulse Input (Terminal RP)
b1-02	Run Command Selection	0: Digital Operator - RUN and STOP keys <b>1: Terminals - Digital Inputs</b> 2: Serial Com - RS-422/485 3: Option board connected

Par.	Name	Description
b1-03	Stopping Method Selection	Selects the stopping method when the run command is removed. <b>0: Ramp to Stop</b> 1: Coast to Stop 2: DC Injection Braking to Stop 3: Coast with Timer (a new run command is ignored if received before the timer expires)
b1-04	Reverse Operation Selection	<b>0: Reverse enabled</b> 1: Reverse prohibited
b1-14	Phase Order Selection	Switches the output phase order. <b>0: Standard</b> 1: Switch phase order
<b>DC Injection Braking</b>		
b2-01	DC Injection Braking Start Frequency	Sets the frequency at which DC Injection Braking starts when Ramp to Stop (b1-03 = 0) is selected. If b2-01 < E1-09, DC Injection Braking starts at E1-09.
b2-02	DC Injection Braking Current	Sets the DC Injection Braking current as a percentage of the drive rated current. In OLV the DC excitation current is determined by E2-03.
b2-03	DC Inj. Braking Time/DC Excitation Time at Start	Sets the time of DC Injection Braking at start in units of 0.01 seconds. Disabled when set to 0.00 seconds.
b2-04	DC Inj. Braking Time at Stop	Sets the DC Injection Braking time at stop. Disabled when set to 0.00 seconds.
<b>Acceleration/ Deceleration</b>		
C1-01	Accel Time 1	Sets the acceleration time 1 from 0 to the max. output frequency.
C1-02	Decel Time 1	Sets the deceleration time 1 from the max. output frequency to 0.

## 6 Parameter Table

Par.	Name	Description
C1-03 to C1-08	Accel/Decel Times 2 to 4	Set the accel/decel times 2 to 4 (set like C1-01/02).
C2-01	S-Curve 1	S-curve at acceleration start.
C2-02	S-Curve 2	S-curve at acceleration end.
C2-03	S-Curve 3	S-curve at deceleration start.
C2-04	S-Curve 4	S-curve at deceleration end.
<b>Slip Compensation</b>		
C3-01	Slip Compensation Gain	<ul style="list-style-type: none"> <li>• Increase if the speed is lower than the frequency reference.</li> <li>• Decrease if the speed is higher than the frequency reference.</li> </ul>
C3-02	Slip Compensation Delay Time	<ul style="list-style-type: none"> <li>• Decrease the setting when the slip compensation is too slow.</li> <li>• Increase the setting when the speed is not stable.</li> </ul>
<b>Torque Compensation</b>		
C4-01	Torque Compensation Gain	<ul style="list-style-type: none"> <li>• Increase this setting when the torque response is slow.</li> <li>• Decrease this setting when speed/torque oscillations occur.</li> </ul>
C4-02	Torque Compensation Delay Time	<ul style="list-style-type: none"> <li>• Increase this setting when speed /torque oscillations occur.</li> <li>• Decrease the setting when the torque response is too slow.</li> </ul>
<b>Duty Mode and Carrier Frequency</b>		
C6-01	Normal/ Heavy Duty Selection	<b>0: Heavy Duty (HD)</b> <b>Constant torque applications</b> <b>1: Normal Duty (ND)</b> Variable torque application
C6-02	Carrier Frequency Selection	1: 2.0 kHz 2: 5.0 kHz 3: 8.0 kHz 4: 10.0 kHz 5: 12.5 kHz 6: 15.0 kHz 7 to A: Swing PWM1 to 4 B: Leakage Current Rejection PWM F: User defined

Par.	Name	Description
<b>Frequency References</b>		
d1-01 to d1-16	Frequency Reference 1 to 16	Set the multi-speed references 1 to 16.
d1-17	Jog Speed	Jog speed
<b>V/f Pattern</b>		
E1-01	Input Voltage Setting	Input Voltage
E1-04	Max. Output Frequency	For a linear V/f characteristics, set the same values for E1-07 and E1-09. In this case, the setting for E1-08 will be disregarded. Ensure that the five frequencies are set according to these rules or an oPE10 fault will occur: $E1-09 \leq E1-07 < E1-06 \leq E1-11 \leq E1-04$  <b>Note:</b> Setting E1-11 to 0 disables both E1-11 and E1-12, and the above conditions do not apply.
E1-05	Max. Output Voltage	
E1-06	Base Frequency	
E1-07	Mid. Output Frequency	
E1-08	Mid. Output Voltage	
E1-09	Min. Output Frequency	
E1-10	Min. Output Voltage	
E1-11	Mid. Output Frequency 2	
E1-12	Mid. Output Frequency Voltage 2	
E1-13	Base Voltage	
<b>Motor Data</b>		
E2-01	Motor Rated Current	Automatically set during Auto-Tuning.
E2-02	Motor Rated Slip	Motor rated slip in hertz (Hz). Automatically set by Rotational Auto-Tuning.
E2-03	Motor No-Load Current	Magnetizing current in Ampere. Automatically set by Rotational Auto-Tuning.

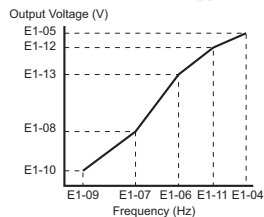

## 6 Parameter Table

Par.	Name	Description
E2-04	Motor Poles	Number of motor poles. Automatically set by Auto-Tuning.
E2-05	Motor Line-to-Line Resistance	Sets the phase-to-phase motor resistance in ohms. Automatically set by Auto-Tuning.
E2-06	Motor Leakage Inductance	Sets the voltage drop due to motor leakage inductance as a percentage of motor rated voltage. Automatically set by Auto-Tuning.
Digital Input Settings		
H1-01 to H1-06	DI S1 to S6 Function Selection	Selects the function of terminals S1 to S6.
Major functions are listed at the end of the table.		
Digital Output Settings		
H2-01	DO MA/MB Function	Set the function for the relay output MA-MB-MC.
H2-02	DO P1 Function	Sets the function for the photocoupler output P1.
H2-03	DO P2 Function	Sets the function for the photocoupler output P2.
Major functions are listed at the end of the table.		
Analog Input Setting		
H3-01	A1 Signal Level Sel.	<b>0:0 to +10 V (neg. input is zeroed)</b> 1:0 to +10 V (bipolar input)
H3-02	A1 Function Sel.	Assign a function to terminal A1.
H3-03	A1 Gain	Sets the input value in % at 10 V analog input.
H3-04	A1 Bias	Sets the input value in % at 0 V analog input.
H3-09	A2 Signal Level Selection	0:0 to +10 V (neg. input is zeroed) 1:0 to +10 V (bipolar input) <b>2:4 to 20 mA (9 bit input)</b> 3:0 to 20 mA
H3-10	A2 Function Sel.	Assign a function to terminal A2.
H3-11	A2 Gain	Sets the input value in % at 10 V/20 mA analog input.

Par.	Name	Description
H3-12	A2 Bias	Sets the input value in % at 0 V/0 mA/4 mA analog input.
Analog Input Setting		
H4-01	AM Monitor Selection	Enter value equal to U1-□□ monitor values. Example: Enter "103" for U1-03.
H4-02	AM Gain	Sets terminal AM output voltage equal to 100% monitor value.
H4-02	AM Bias	Sets terminal AM output voltage equal to 0% monitor value.
Pulse Input Setting (Free. ref. input)		
H6-02	RP Input Scaling	Sets the number of pulses (in Hz) that is equal to 100% input value.
H6-03	Pulse Train Input Gain	Sets the input value in % at pulse input with H6-02 frequency.
H6-04	Pulse Train Input Bias	Sets the input value in % at 0 Hz pulse input frequency.
Pulse Output Setting		
H6-06	MP Monitor Sel.	Enter value equal to U□-□□ monitor values. Example: Enter "102" for U1-02.
H6-07	MP Monitor Scaling	Sets the number of output pulses when the monitor is 100% (in Hz).
Motor Overheat Protection		
L1-01	Motor Overload Prot. Sel.	Sets the motor overload protection. 0:Disabled <b>1:Standard fan cooled motor</b> 2:Standard blower cooled motor 3:Vector motor
L1-02	Motor Overload Prot. Time	Sets the motor overload protection time in min. Normally no change is necessary.

Par.	Name	Description
<b>Stall Prevention</b>		
L3-01	Stall Prevention Selection during Accel.	0: Disabled - Motor accelerates at active acceleration rate and may stall with too heavy load or too short accel time. <b>1: General Purpose - Hold acceleration when current is above L3-02.</b> 2: Intelligent - Acceleration in the shortest possible time.
L3-02	Stall Prev. Level during Accel.	Sets the current level for stall prevention during acceleration.
L3-04	Stall Prev. Selection during Decel.	0: Disabled - Deceleration as set. ov might occur. <b>1: General Purpose - Deceleration is hold if DC bus voltage rises high.</b> 2: Intelligent 3: Stall Prevention with Braking Resistor 4: Overexcitation Deceleration 7: Overexcitation Deceleration 3
L3-05	Stall Prev. Selection during Run	0: Disabled - Motor stall or overload might occur. <b>1: Decel Time 1 - Reduce speed using C1-02.</b>
L3-06	Stall Prev. Level during Run	Sets the current level at which stall prevention during run starts to operate.
<b>Auto-Tuning</b>		
T1-01	Auto-Tuning Mode Selection	0: Rotational Auto-Tuning 2: Terminal resistance only 3: Rotational Auto-Tuning for Energy Saving
T1-02	Rated Power	Sets the motor rated power (kW).
T1-03	Rated Voltage	Sets the motor rated voltage (V).
T1-04	Rated Current	Sets the motor rated current (A).
T1-05	Base Frequency	Sets the motor base frequency (Hz).
T1-06	Motor Poles	Sets the number of motor poles.
T1-07	Base Speed	Sets the motor base speed (RPM).
T1-11	Motor Iron Loss	Iron loss for determining the Energy Saving coefficient. If unknown leave it on default.

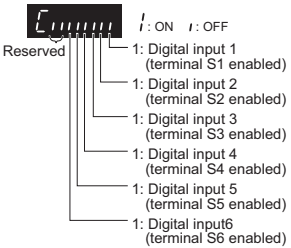
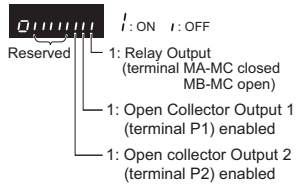
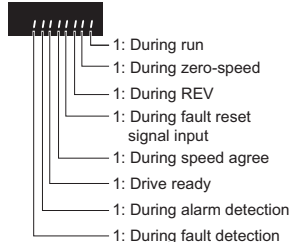
Monitor	Description
U1-01	Frequency Reference (Hz)
U1-02	Output Frequency (Hz)
U1-03	Output Current (A)
U1-05	Motor Speed (Hz)
U1-06	Output Voltage Reference (Vac)
U1-07	DC Bus Voltage (Vdc)
U1-08	Output Power (kW)
U1-09	Torque Reference (% of motor rated torque)
U1-10	<p>Input Terminal Status</p> 
U1-11	<p>Output Terminal Status</p> 
U1-12	<p>Drive Status</p> 
U1-13	Terminal A1 input level
U1-14	Terminal A2 input level

## 6 Parameter Table

Monitor	Description
U1-16	Soft Starter Output (freq after accel/decel ramps)
U1-18	oPE Fault Parameter
U1-24	Pulse Input frequency
Fault Trace	
U2-01	Current Fault
U2-02	Previous Fault
U2-03	Frequency Reference at Previous Fault
U2-04	Output Frequency at Previous Fault
U2-05	Output Current at Previous Fault
U2-06	Motor Speed at Previous Fault
U2-07	Output Voltage at Previous Fault
U2-08	DC Bus Voltage at Previous Fault
U2-09	Output Power at Previous Fault
U2-10	Torque Reference at Previous Fault
U2-11	Input Terminal Status at Previous Fault
U2-12	Output Terminal Status at Previous Fault
U2-13	Drive Operation Status at Previous Fault
U2-14	Cumulative Operation Time at Previous Fault
U2-15	Soft-Starter Speed Reference at Previous Fault
U2-16	Motor q-Axis Current at Previous Fault
U2-17	Motor d-Axis Current at Previous Fault
Fault History	
U3-01 to U3-04	Lists the most recent fault that occurred through the fourth most recent fault.
U3-05 to U3-08	Accumulated operation time at the most recent fault through the fourth most recent fault.
U3-09 to U3-14	Lists the fifth most recent fault that occurred through the tenth most recent fault.
U3-15 to U3-20	Accumulated operation time at fifth most recent fault through the tenth most recent fault.
* The following faults are not recorded in the error log: CPF00, 01, 02, 03, UV1, and UV2.	

DI/DO Sel.	Description
Digital Input Function Selections	
3	Multi-step speed reference 1
4	Multi-step speed reference 2
5	Multi-step speed reference 3
6	Jog frequency command (higher priority than multi-step speed reference)
7	Accel/decel time selection 1
F	Not used (Set when a terminal is not used)
14	Fault reset (Reset when turned ON)
20 to 2F	External fault; Input mode: N.O. contact / N.C. contact, Detection mode: Normal/during operation
Digital Output Function Selections	
0	During Run (ON: run command is ON or voltage is being output)
1	Zero Speed
2	Speed Agree
6	Drive Ready
E	Fault
F	Not used
10	Minor fault (Alarm) (ON: Alarm displayed)



## 7 Troubleshooting

### ◆ General Fault and Alarms

Faults and alarms indicate problems in the drive or in the machine.

An alarm is indicated by a code on the data display and the flashing ALM LED. The drive output is not necessarily switched off.

A fault is indicated by a code on the data display and the ALM LED is on. The drive output is always switched off immediately and the motor coast to stop.

To remove an alarm or reset a fault, trace the cause, remove it and reset the drive by pushing the Reset key on the operator or cycling the power supply.

This lists up the most important alarms and faults only. Please refer to the Technical Manual for a complete list.

LED Display	AL	FLT	Cause	Corrective Action
Base Block bb	○		The software base block function is assigned to one of the digital inputs and the input is off. The drive does not accept Run commands.	<ul style="list-style-type: none"> <li>Check the digital inputs function selection.</li> <li>Check the upper controller sequence.</li> </ul>
Control Fault CF		○	The torque limit was reached during deceleration for longer than 3 sec. when in Open Loop Vector control. <ul style="list-style-type: none"> <li>The load inertia is too big.</li> <li>The torque limit is too low.</li> <li>The motor parameters are wrong.</li> </ul>	<ul style="list-style-type: none"> <li>Check the load.</li> <li>Set the torque limit to the most appropriate setting (L7-01 through L7-04).</li> <li>Check the motor parameters.</li> </ul>
Control Circuit Fault CPF02 to CPF24		○	There is a problem in the drive's control circuit.	<ul style="list-style-type: none"> <li>Cycle the drive power supply.</li> <li>Initialize the drive.</li> <li>Replace the drive if the fault occurs again.</li> </ul>
Control Circuit Fault CPF25		○	There is no terminal board connected to the control board.	<ul style="list-style-type: none"> <li>Check if the terminal board is installed properly.</li> <li>Uninstall and Reapply the terminal board.</li> <li>Change the drive.</li> </ul>
Cannot Reset CR5F	○		Fault reset was input when a Run command was active.	Turn off the Run command and reset the drive.
Option External Fault EF	○	○	An external fault was tripped by the upper controller via an option card.	<ul style="list-style-type: none"> <li>Remove the fault cause, reset the fault and restart the drive.</li> <li>Check the upper controller program.</li> </ul>
External Fault EF	○		A forward and reverse command were input simultaneously for longer than 500 ms. This alarm stops a running motor.	<ul style="list-style-type: none"> <li>Check the sequence and make sure that the forward and reverse input are not set at the same time.</li> </ul>

## 7 Troubleshooting

LED Display	AL	FLT	Cause	Corrective Action
External Faults <i>EF1</i> to <i>EF6</i>	○	○	<ul style="list-style-type: none"> <li>An external fault was triggered by an external device via one of the digital inputs S1 to S6.</li> <li>The digital inputs are set up incorrectly.</li> </ul>	<ul style="list-style-type: none"> <li>Find out why the device tripped the EF. Remove the cause and reset the fault.</li> <li>Check the functions assigned to the digital inputs.</li> </ul>
Ground Fault <i>GF</i>		○	<ul style="list-style-type: none"> <li>Ground leakage current has exceeded 50% of the drives rated output current.</li> <li>Cable or motor insulation is broken.</li> <li>Excessive stray capacitance at drive output.</li> </ul>	<ul style="list-style-type: none"> <li>Check the output wiring and the motor for short circuits or broken insulation.</li> <li>Replace any broken parts.</li> <li>Reduce the carrier frequency.</li> </ul>
Safe Disable <i>Hbb</i>	○		Both Safe Disable inputs are open. The drive output is safely disabled and the motor can not be started.	<ul style="list-style-type: none"> <li>Check why the upper controller's safety device disabled the drive. Remove the cause and restart.</li> <li>Check the wiring.</li> <li>If the Safe Disable function is not utilized for IEC/EN 61800-5-2, stop cat. 0 or for disabling the drive, the terminals HC, H1, H2 must be linked.</li> </ul>
Safe Disable Fault <i>HbbF</i>	○		<p>Drive output is disabled while only one of the Safe Disable inputs is open. (normally both input signals H1 and H2 should be open)</p> <ul style="list-style-type: none"> <li>One channel is internally broken and does not switch off, even if the external signal is removed.</li> <li>Only one channel is switched off by the upper controller.</li> </ul>	<ul style="list-style-type: none"> <li>Check the wiring from the upper controller and make sure that both signals are set correctly by the controller.</li> <li>If the signals are set correctly and the alarm does not disappear, replace the drive.</li> </ul>
Output Phase Loss <i>LF</i>		○	<p>Output cable is disconnected or the motor winding is damaged.</p> <p>Loose wires at the drive output.</p> <p>Motor is too small (less than 5% of drive current).</p>	<ul style="list-style-type: none"> <li>Check the power supply.</li> <li>Make sure that all cables are properly fixed to the correct terminals.</li> </ul>
Overcurrent <i>oC</i>		○	<p>Short circuit or ground fault on the drive output side</p> <p>The load is too heavy.</p> <p>The accel./decel. times are too short.</p> <p>Wrong motor data or V/f pattern settings.</p> <p>A magnetic contactor was switched at the output.</p>	<ul style="list-style-type: none"> <li>Check the output wiring and the motor for short circuits or broken insulation. Replace the broken parts.</li> <li>Check the machine for damages (gears, etc.) and repair any broken parts.</li> <li>Check the drive parameter settings.</li> <li>Check the output contactor sequence.</li> </ul>
Heatsink Overheat <i>oH</i> or <i>oH1</i>	○	○	<p>Surrounding temperature is too high.</p> <p>The cooling fan has stopped.</p> <p>The heatsink is dirty.</p> <p>The airflow to the heatsink is restricted.</p>	<ul style="list-style-type: none"> <li>Check the surrounding temperature and install cooling devices if necessary.</li> <li>Check the drive cooling fan.</li> <li>Clean the heatsink.</li> <li>Check the airflow around the heatsink.</li> </ul>

## 7 Troubleshooting

LED Display	AL	FLT	Cause	Corrective Action
Motor Overload OL1		○	The motor load is too heavy. The motor is operated at low speed with heavy load. Cycle times of accel./decel. are too short. Incorrect motor rated current has been set.	<ul style="list-style-type: none"> <li>Reduce the motor load.</li> <li>Use a motor with external cooling and set the correct motor in parameter L1-01.</li> <li>Check the sequence.</li> <li>Check the rated current setting.</li> </ul>
Drive Overload OL2		○	The load is too heavy. The drive capacity is too small. Too much torque at low speed.	<ul style="list-style-type: none"> <li>Check the load.</li> <li>Make sure that the drive is big enough to handle the load.</li> <li>The overload capability is reduced at low speeds. Reduce the load or increase the drive size.</li> </ul>
DC Overvoltage OU	○	○	DC bus voltage rose too high. The deceleration time is too short. Stall prevention is disabled. Braking chopper / resistor broken. Unstable motor control in OLV. Too high input voltage.	<ul style="list-style-type: none"> <li>Increase the deceleration time.</li> <li>Enable stall prevention by parameter L3-04.</li> <li>Make sure the braking resistor and braking chopper are working correctly.</li> <li>Check motor parameter settings and adjust torque and slip compensation, AFR and hunting prevention as needed.</li> <li>Make sure that the power supply voltage meets the drives specifications.</li> </ul>
Input Phase Loss PF		○	Input voltage drop or phase imbalance. One of the input phase is lost. Loose wires at the drive input.	<ul style="list-style-type: none"> <li>Check the motor wiring.</li> <li>Make sure all terminal screws in the drive and motor are properly tightened.</li> <li>Check the motor and drive capacity.</li> </ul>
Braking Transistor Fault rr		○	The internal braking transistor is broken.	<ul style="list-style-type: none"> <li>Cycle the power supply.</li> <li>Replace the drive if the fault reoccurs.</li> </ul>
IGBT Short Circuit Sc		○	IGBT short circuit detection and circuit fault	<ul style="list-style-type: none"> <li>Check motor wiring</li> <li>Cycle power to the drive.</li> <li>If the problem continues, contact your YASKAWA representative or the nearest YASKAWA sales office.</li> </ul>
DC Undervoltage UV1	○	○	The voltage in the DC bus fell below the undervoltage detection level (L2-05). The power supply failed or one input phase has been lost. The power supply is too weak.	<ul style="list-style-type: none"> <li>Check the power supply.</li> <li>Make sure, that the power supply is strong enough.</li> </ul>
Controller Undervoltage UV2		○	The drives controller power supply voltage is too low.	<ul style="list-style-type: none"> <li>Cycle power to the drive. Check if the fault reoccurs.</li> <li>Replace the drive if the fault continues to occur.</li> </ul>

## 7 Troubleshooting

LED Display	AL	FLT	Cause	Corrective Action
DC Charge Circuit Fault U03		○	The charge circuit for the DC bus is broken.	<ul style="list-style-type: none"> <li>• Cycle power to the drive. Check if the fault reoccurs.</li> <li>• Replace the drive if the fault reoccurs.</li> </ul>

### ◆ Operator Programing Errors

An Operator Programming Error (oPE) occurs when an inapplicable parameter is set or an individual parameter setting is inappropriate. When an oPE error is displayed, press the ENTER button to display U1-18 (oPE fault constant). This monitor will display the parameter that is causing the oPE error.

LED Operator Display	Cause	Corrective Action
oPE01 oPE01	Drive capacity and value set to o2-04 do not match.	Correct the value set to o2-04.
oPE02 oPE02	Parameters were set outside the allowable setting range.	Set parameters to the proper values.
oPE03 oPE03	<p>A contradictory setting is assigned to multi-function contact inputs H1-01 through to H1-06.</p> <ul style="list-style-type: none"> <li>• The same function is assigned to two inputs. (this excludes “External fault” and “Not used”)</li> <li>• Input functions which require the setting of other input functions were set alone.</li> <li>• Input functions that are not allowed to be used simultaneously have been set.</li> </ul>	<ul style="list-style-type: none"> <li>• Fix any incorrect settings.</li> <li>• Refer to the Technical Manual for more details.</li> </ul>
oPE05 oPE05	<ul style="list-style-type: none"> <li>• The run command source (b1-02) or frequency reference source (b1-01) is set to 3 but no option board is installed.</li> <li>• The frequency reference source is set to pulse input but H6-01 is not 0.</li> </ul>	<ul style="list-style-type: none"> <li>• Install the required option board.</li> <li>• Correct the values set to b1-01 and b1-02.</li> </ul>
oPE07 oPE07	<p>Settings to multi-function analog inputs H3-02 and H3-10 and PID functions conflict.</p> <ul style="list-style-type: none"> <li>• H3-02 and H3-10 are set to the same value. (this excludes settings “0” and “F”)</li> <li>• PID functions have been assigned to both analog inputs and the pulse input at the same time.</li> </ul>	<ul style="list-style-type: none"> <li>• Fix any incorrect setting.</li> <li>• Refer to the Technical Manual for more details.</li> </ul>
oPE08 oPE08	A function has been set that cannot be used in the control mode selected.(might appear after control mode change)	<ul style="list-style-type: none"> <li>• Fix any incorrect setting.</li> <li>• Refer to the Technical Manual for more details.</li> </ul>

LED Operator Display	Cause	Corrective Action
oPE10 0PE10	The V/f pattern setting is incorrect.	<ul style="list-style-type: none"> <li>• Check the V/f pattern settings.</li> <li>• Refer to the Technical Manual for more details.</li> </ul>

### ◆ Auto-Tuning Errors

LED Operator Display	Cause	Corrective Action
Er-01 Er-01	Motor data fault The input motor data are not valid. (e.g. the base frequency and base speed do not fit)	Re-enter the data and repeat Auto-Tuning.
Er-02 Er-02	Minor Fault <ul style="list-style-type: none"> <li>• The wiring is faulty.</li> <li>• The load is too heavy.</li> </ul>	<ul style="list-style-type: none"> <li>• Check the wiring.</li> <li>• Check the load. Always perform Auto-Tuning with the load decoupled from the motor.</li> </ul>
Er-03 Er-03	The STOP button was pressed and Auto-Tuning was canceled.	Repeat the Auto-Tuning.
Er-04 Er-04	Resistance fault <ul style="list-style-type: none"> <li>• Wrong input data</li> <li>• Auto tuning exceeded the given time frame.</li> <li>• Calculated values out of range.</li> </ul>	<ul style="list-style-type: none"> <li>• Check the input data.</li> <li>• Check the wiring.</li> <li>• Re-enter the data and repeat the Auto-Tuning.</li> </ul>
Er-05 Er-05	No-Load Current Error <ul style="list-style-type: none"> <li>• Incorrect data was entered.</li> <li>• Auto tuning took too long.</li> <li>• Calculated values out of range</li> </ul>	
Er-08 Er-08	Rated Slip Error <ul style="list-style-type: none"> <li>• Wrong data input</li> <li>• Auto tuning exceeded the given time frame.</li> <li>• Calculated values out of range</li> </ul>	
Er-09 Er-09	Acceleration error The motor did not accelerate for the specified acceleration time.	<ul style="list-style-type: none"> <li>• Increase the acceleration time C1-01.</li> <li>• Check the torque limits L7-01 and L7-02.</li> </ul>
Er-11 Er-11	Motor speed fault The torque reference was too high.	<ul style="list-style-type: none"> <li>• Increase the acceleration time (C1-01).</li> <li>• If possible, disconnect the load.</li> </ul>
Er-12 Er-12	Current detection error <ul style="list-style-type: none"> <li>• One or all output phases are lost.</li> <li>• Current is either too low or exceeds the drives rating.</li> <li>• The current sensors are faulty.</li> </ul>	<ul style="list-style-type: none"> <li>• Check the wiring.</li> <li>• Make sure, that the drive rating fits to the motor.</li> <li>• Check the load. (Auto-Tuning should have been performed without the load connected.)</li> <li>• Replace the drive.</li> </ul>

## 7 Troubleshooting

LED Operator Display	Cause	Corrective Action
End1 <i>End1</i>	Rated current alarm <ul style="list-style-type: none"> <li>• The torque reference exceeded 20% during Auto-Tuning.</li> <li>• The calculated no-load current is above 80% of the motor rated current.</li> </ul>	<ul style="list-style-type: none"> <li>• Check the V/f pattern setting.</li> <li>• Perform Auto-Tuning without the load connected.</li> <li>• Check the input data and repeat Auto-Tuning.</li> </ul>
End2 <i>End2</i>	Motor iron-core saturation alarm <ul style="list-style-type: none"> <li>• Calculated core saturation values out of range.</li> <li>• Incorrect data was entered.</li> </ul>	<ul style="list-style-type: none"> <li>• Check the input data.</li> <li>• Check the motor wiring.</li> <li>• Perform Auto-Tuning without load connected.</li> </ul>
End3 <i>End3</i>	Rated current alarm	Check the input data and repeat tuning.

## 8 Instructions for UL and cUL

### ◆ UL Standards Compliance

This drive is tested in accordance with UL standard UL508C, File No. E131457 and complies with UL requirements. To ensure continued compliance when using this drive in combination with other equipment, meet the following conditions:

#### ■ Installation Area

Do not install the drive to an area greater than pollution severity 2 (UL standard).

#### ■ Ambient Temperature

IP20/NEMA Type1 enclosure: -10 to +40°C  
 IP20/IP00 Open-Chassis enclosure: -10 to +50°C  
 Finless Type: IP20/IP00 enclosure: -10 to +50°C  
 NEMA Type4X/IP66 enclosure: -10 to +40°C

#### ■ Main Circuit Terminal Wiring

YASKAWA recommends using UL-listed copper wires (rated at 75°C) and closed-loop connectors sized for the selected wire gauge to maintain proper clearances when wiring the drive. Use the correct crimp tool to install connectors per manufacturer recommendation. The following table lists a suitable closed-loop connector manufactured by JST Corporation.

**Table 1 Closed-Loop Crimp Terminal Size (JIS C 2805) (same for 200 V and 400 V)**

Wire Gauge mm <sup>2</sup> (AWG)	Terminal Screws	Crimp Terminal Model Number	Tightening Torque N·m (lb·in.)
0.75 (18)	M3.5	R1.25-3.5	0.8 to 1.0 (7.1 to 8.9)
	M4	R1.25-4	1.2 to 1.5 (10.6 to 13.3)
1.25 (16)	M3.5	R1.25-3.5	0.8 to 1.0 (7.1 to 8.9)
	M4	R1.25-4	1.2 to 1.5 (10.6 to 13.3)
2 (14)	M3.5	R2-3.5	0.8 to 1.0 (7.1 to 8.9)
	M4	R2-4	1.2 to 1.5 (10.6 to 13.3)
	M5	R2-5	2.0 to 2.5 (17.7 to 22.1)
	M6	R2-6	5.4 to 6.0 (47.8 to 53.1)
3.5/5.5 (12/10)	M4	R5.5-4	1.2 to 1.5 (10.6 to 13.3)
	M5	R5.5-5	2.0 to 2.5 (17.7 to 22.1)
	M6	R5.5-6	5.4 to 6.0 (47.8 to 53.1)
	M8	R5.5-8	9.9 to 11.0 (87.6 to 97.4)

## 8 Instructions for UL and cUL

Wire Gauge mm <sup>2</sup> (AWG)	Terminal Screws	Crimp Terminal Model Number	Tightening Torque N·m (lb·in.)
8 (8)	M4	8-4	1.2 to 1.5 (10.6 to 13.3)
	M5	R8-5	2.0 to 2.5 (17.7 to 22.1)
	M6	R8-6	5.4 to 6.0 (47.8 to 53.1)
	M8	R8-8	9.9 to 11.0 (87.6 to 97.4)
14 (6)	M4	14-4	1.2 to 1.5 (10.6 to 13.3)
	M5	R14-5	2.0 to 2.5 (17.7 to 22.1)
	M6	R14-6	5.4 to 6.0 (47.8 to 53.1)
	M8	R14-8	9.9 to 11.0 (87.6 to 97.4)
22 (4)	M6	R22-6	5.4 to 6.0 (47.8 to 53.1)
	M8	R22-8	9.9 to 11.0 (87.6 to 97.4)
30/38 (3/2)	M8	R38-8	9.9 to 11.0 (87.6 to 97.4)

**Note:** Use crimp insulated terminals or insulated tubing for wiring these connections. Wires should have a continuous maximum allowable temperature of 75°C 600 V UL approved vinyl sheathed insulation. Ambient temperature should not exceed 30°C.

### Input Fuse Selection

Branch circuit protection shall be provided by any of the following:

- Non-time delay Class J, T, or CC fuses sized at 300% of the drive input rating
- Note:** Exceptional models are A6T6 with 2A0002, A6T15 with 2A0004 or 4A0004, A6T20 with 4A0005, and A6T25 with 4A0007.
- Time delay Class J, T, or CC fuses sized at 175% of the drive input rating
  - Time-delay Class RK5 fuses sized at 225% of the drive input rating

Model CIMR-V□	Non-Time Delay Class-T Fuse Type (Manufacturer: Ferraz)	Fuse Ampere Rating (A)	Fuse Type (Manufacturer: Bussmann) 500 Vac, 200 kAIR	Fuse Ampere Rating (A)
Single-Phase 200 V Class				
BA0001	A6T6	6	FWH-25A14F	25
BA0002	A6T10	10	FWH-25A14F	25
BA0003	A6T20	20	FWH-60B	60
BA0006	A6T40	40	FWH-80B	80
BA0010	A6T40	40	FWH-100B	100
BA0012	A6T50	50	FWH-125B	125
BA0018	A6T80	80	FWH-175B	175
Three-Phase 200 V Class				
2A0001	A6T3	3	FWH-25A14F	25
2A0002	A6T6	6	FWH-25A14F	25
2A0004	A6T15	15	FWH-25A14F	25



## 8 Instructions for UL and cUL

Model CIMR-V□	Non-Time Delay Class-T Fuse Type (Manufacturer: Ferraz)	Fuse Ampere Rating (A)	Fuse Type (Manufacturer: Bussmann) 500 Vac, 200 kAIR	Fuse Ampere Rating (A)
2A0006	A6T20	20	FWH-25A14F	25
2A0010	A6T25	25	FWH-70B	70
2A0012	A6T25	25	FWH-70B	70
2A0020	A6T40	40	FWH-90B	90
2A0030	Not Available		FWH-100B	100
2A0040			FWH-200B	200
2A0056			FWH-200B	200
2A0069			FWH-200B	200
Three-Phase 400 V Class				
4A0001	A6T3	3	FWH-40B	40
4A0002	A6T6	6	FWH-40B	40
4A0004	A6T15	15	FWH-50B	50
4A0005	A6T20	20	FWH-70B	70
4A0007	A6T25	25	FWH-70B	70
4A0009	A6T25	25	FWH-90B	90
4A0011	A6T30	30	FWH-90B	90
4A0018	Not Available		FWH-80B	80
4A0023			FWH-100B	100
4A0031			FWH-125B	125
4A0038			FWH-200B	200

### ■ Low Voltage Wiring for Control Circuit Terminals

Wire low voltage wires with NEC Class 1 circuit conductors; refer to national state or local codes for wiring. Use a class 2 (UL listed) power supply for the control circuit terminal.

**Table 2 Control Circuit Terminal Power Supply**

Input / Output	Terminal Signal	Power Supply Specifications
Multi-function photocoupler outputs	P1, P2, PC	Requires class 2 power supply.
Multi-function digital inputs	S1, S2, S3, S4, S5, S6, SC	Use the internal LVLC power supply of the drive. Use class 2 for external power supply.
Multi function analog inputs	+V, A1, A2, AC	Use the internal LVLC power supply of the drive. Use class 2 for external power supply.
Pulse train input	RP	Use the internal LVLC power supply of the drive. Use class 2 for external power supply.
Pulse train output	MP	Use the internal LVLC power supply of the drive. Use class 2 for external power supply.

## 8 Instructions for UL and cUL

---

### ■ Drive Short-Circuit Rating

This drive has undergone the UL short-circuit test, which certifies that during a short circuit in the power supply the current flow will not rise above 31,000 Amps maximum at 240 V for 200 V class drives and 440 V for 400 V class drives.

- The MCCB and breaker protection and fuse ratings (refer to the preceding table) shall be equal to or greater than the short-circuit tolerance of the power supply being used.
- Suitable for use on a circuit capable of delivering not more than 31,000 RMS symmetrical amperes for 240 V in 200 V class drives (up to 440 V for 400 V class drives) motor overload protection.

---

### ◆ Drive Motor Overload Protection

Set parameter E2-01 (motor rated current) to the appropriate value to enable motor overload protection. The internal motor overload protection is UL listed and in accordance with the NEC and CEC.

#### ■ E2-01 Motor Rated Current

Setting Range: Model Dependent

Factory Default: Model Dependent

The motor rated current parameter (E2-01) protects the motor and allows for proper vector control when using open loop vector or flux vector control methods (A1-02 = 2 or 3). The motor protection parameter L1-01 is set as factory default. Set E2-01 to the full load amps (FLA) stamped on the nameplate of the motor.

The operator must enter the rated current of the motor (T1-04) in the menu during auto-tuning. If the auto-tuning operation completes successfully (T1-02 = 0), the value entered into T1-04 will automatically write into E2-01.

#### ■ L1-01 Motor Overload Protection Selection

The drive has an electronic overload protection function (oL1) based on time, output current, and output frequency, which protects the motor from overheating. The electronic thermal overload function is UL-recognized, so it does not require an external thermal overload relay for single motor operation.

This parameter selects the motor overload curve used according to the type of motor applied.

**Table 3 Overload Protection Settings**

Setting	Description
<b>0</b>	Disabled
<b>1</b>	Standard fan cooled motor (default)
<b>2</b>	Inverter duty motor with a speed range of 1:10
<b>3</b>	Vector motor with a speed range of 1:100
<b>4</b>	Permanent Magnet Motor

Disable the electronic overload protection (L1-01 = “0: Disabled”) and wire each motor with its own motor thermal overload when connecting the drive to more than one motor for simultaneous operation.

Enable the motor overload protection (L1-01 = 1, 2, or 3) when connecting the drive to a single motor unless there is another means of preventing motor thermal overload. The electronic thermal overload function causes an oL1 fault, which shuts off the output of the drive and prevents additional overheating of the motor. The motor temperature is continually calculated as long as the drive is powered up.

Setting L1-01 = 1 selects a motor with limited cooling capability below rated (base) speed when running at 100% load. The oL1 function derates the motor any time it is running below base speed.

Setting L1-01 = 2 selects a motor capable of cooling itself over a 10:1 speed range when running at 100% load. The oL1 function derates the motor when it is running at 1/10 or less of its rated speed.

Setting L1-01 = 3 selects a motor capable of cooling itself at any speed – including zero speed – when running at 100% load. The oL1 function does not derate the motor at any speed.

Setting L1-01 = 4 selects protection for a PM motor.

### ■ L1-02 Motor Overload Protection Time

Setting Range: 0.1 to 5.0 Minutes

Factory Default: 1.0 Minutes

The L1-02 parameter will set the allowed operation time before the oL1 fault will occur when the drive is running at 60 Hz and 150% of the motor’s full load amp rating (E2-01). Adjusting the value of L1-02 can shift the set of oL1 curves up the Y-axis of the diagram below but will not change the shape of the curves.

## 8 Instructions for UL and cUL

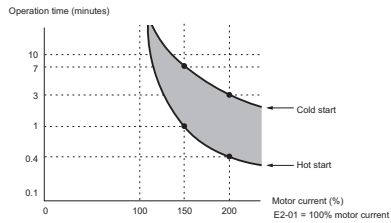

**Figure 3 Motor Overload Protection Time**

### ■ L1-03 Motor Overload Alarm Operation Selection

Setting	Description
0	Ramp to Stop
1	Coast to Stop
2	Fast-Stop
3	Alarm Only (factory default)

### ■ L1-04 Motor Overload Fault Operation Selection

Setting	Description
0	Ramp to Stop
1	Coast to Stop (factory default)
2	Fast-Stop

## Revision History

The revision dates and the numbers appear on the bottom of the back cover.

MANUAL NO. TOEP C710606 15E

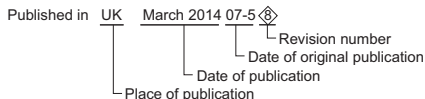

Date of Publication	Rev. No.	Section	Revised Content
March 2014	⑧	All	Revision: <ul style="list-style-type: none"> <li>Upgraded the software version to PRG: S1022.</li> <li>Standards for Safe Disable Function (EN954-1 → ISO/EN 13849-1, EN60204-1 → IEC/EN 61800-5-2)</li> </ul>
		Chapter 2	Revision: Ambient Temperature
		Chapter 8	Addition: Ambient Temperature Revision: Tightening Torque for Closed-Loop Crimp Terminals
September 2013	⑦	Back cover	Revision: Address
January 2011	⑥	Front cover	Revision: Format
		Chapter 8	Revision: Input Fuse Selection
		Back cover	Revision: Address, format
April 2010	⑤	Chapter 1	Revision: <ul style="list-style-type: none"> <li>Safety Warnings on Ground Connection</li> <li>Precautions for UL/cUL Standards Compliance</li> </ul>
		Chapter 3	Revision: <ul style="list-style-type: none"> <li>EMC Filter Type</li> <li>Wiring the Main Circuit Input</li> <li>Ground Connection</li> </ul> Addition: Input Fuse Selection Deletion: Tightening Torque Values
		Chapter 8	Addition: Instructions for UL and cUL
December 2009	④	Revision History	Revision: Example of the revision dates and the numbers
September 2008	③	Chapter2	Addition: Dimensions New models: CIMR-V□2A0030A to 2A0069A CIMR-V□4A0018A to 4A0038A
June 2008	②	Back cover	Revision: Address
April 2008	①	All	Addition: CIMR-V□BA0018
May 2007	–	–	First edition

# YASKAWA AC Drive V1000

## Compact Vector Control Drive

### Quick Start Guide

---

#### EUROPEAN HEADQUARTERS

##### YASKAWA EUROPE GmbH

Hauptstrasse 185, 65760 Eschborn, Germany

Phone: +49 (0)6196 569 500 Fax: +49 (0)6196 569 398

E-mail: [info@yaskawa.eu.com](mailto:info@yaskawa.eu.com) Internet: <http://www.yaskawa.eu.com>

#### U.S.A.

##### YASKAWA AMERICA, INC.

2121 Norman Drive South, Waukegan, IL 60085, U.S.A.

Phone: +1 800 YASKAWA (927-5292) or +1 847 887 7000 Fax: +1 847 887 7310

Internet: <http://www.yaskawa.com>

#### JAPAN

##### YASKAWA ELECTRIC CORPORATION

New Pier Takeshiba South Tower, 1-16-1, Kaigan, Minatoku, Tokyo, 105-6891, Japan

Phone: +81 (0)3 5402 4502 Fax: +81 (0)3 5402 4580

Internet: <http://www.yaskawa.co.jp>

---

## YASKAWA

YASKAWA ELECTRIC CORPORATION

In the event that the end user of this product is to be the military and said product is to be employed in any weapons system the manufacture thereof, the export will fall under the relevant regulations as stipulated in the Foreign Exchange and Foreign Trade Regulations. There be sure to follow all procedures and submit all relevant documentation according to any and all rules, regulations and laws that may apply.

Specifications are subject to change without notice for ongoing product modifications and improvements.

© 2007-2014 YASKAWA ELECTRIC CORPORATION. All rights reserved.



\*TOEPC71060615\*

MANUAL NO. TOEP C710606 15E

Published in U.K. March 2014 07-5   
13-7-6\_YEU