

AC Servo Drives Σ -V Series USER'S MANUAL INDEXER Module

Model: SGD V-OCA03A

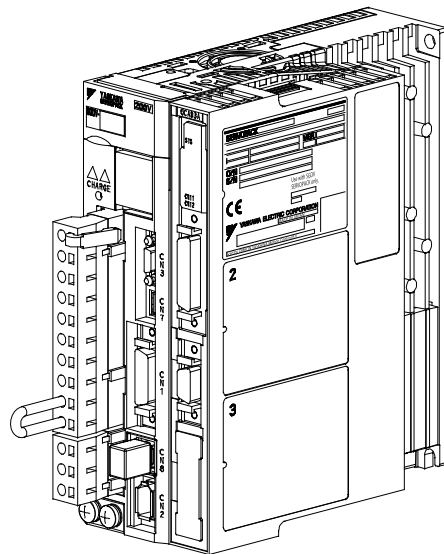

Overview	1
Specifications	2
SERVOPACK Installation	3
Wiring and Connection	4
Parameter Setting and Functions	5
Program Table	6
Serial Command Communications	7
Operation of Digital Operator	8
Troubleshooting	9
Appendix	10

Copyright © 2009 YASKAWA ELECTRIC CORPORATION

All rights reserved. No part of this publication may be reproduced, stored in a retrieval system, or transmitted, in any form, or by any means, mechanical, electronic, photocopying, recording, or otherwise, without the prior written permission of Yaskawa. No patent liability is assumed with respect to the use of the information contained herein. Moreover, because Yaskawa is constantly striving to improve its high-quality products, the information contained in this manual is subject to change without notice. Every precaution has been taken in the preparation of this manual. Nevertheless, Yaskawa assumes no responsibility for errors or omissions. Neither is any liability assumed for damages resulting from the use of the information contained in this publication.

About this Manual

This manual describes information required for designing, trial operating, adjusting and maintaining the INDEXER Module for Σ -V Series SERVOPACKs.

Be sure to refer to this manual and perform design and maintenance to select devices correctly.

Keep this manual in a location where it can be accessed for reference whenever required.

■ Description of Technical Terms

The following table shows the meanings of terms used in this manual.

Term	Meaning
INDEXER Module	INDEXER Module for Σ -V Series SERVOPACKs
Cursor	A mark that indicates the input position of data displayed on the digital operator
Servomotor	Σ -V Series SGMJV, SGMAV, SGMPS, SGMGV, SGMSV, or SGMCS (Direct Drive) servomotor Linear Σ Series SGLGW, SGLFW, SGLTW, or SGLC servomotor
SERVOPACK	Σ -V Series SGD V SERVOPACK
Servo drive	A set including a servomotor and SERVOPACK (i.e., a servo amplifier)
Servo System	A servo control system that includes the combination of a servo drive with a host controller and peripheral devices
Analog/pulse type	Interface specifications for SERVOPACK : Analog voltage and pulse train reference type
Servo ON	When power is being supplied to the servomotor
Servo OFF	When power is not being supplied to the servomotor
Base block	Turning OFF the power by shutting OFF the base current of the IGBT for the current amplifier
Servo lock	Motor status where motor is stopped with a position loop established by a position reference of 0

■ IMPORTANT Explanations

The following icon is displayed for explanations requiring special attention.



IMPORTANT

- Indicates important information that should be memorized, as well as precautions, such as alarm displays, that do not involve potential damage to equipment.

■ Notation Used in this Manual

- Reverse Symbol Notation

In this manual, the names of reverse signals (ones that are valid when low) are written with a forward slash (/) before the signal name, as shown in the following example:

Example

The notation for $\overline{\text{BK}}$ is /BK.

- Parameter Notation

The following two types of notations are used for parameter digit places and settings.

Example

Notation Example for Pn000

Pn000 = n . 0 0 0 0

Digit Notation		Set Value Notation	
Notation Method	Meaning	Notation Method	Meaning
Pn000.0	Indicates digit 1 of the parameter (Pn000).	Pn000.0 = x or n.□□□x	Indicates that digit 1 of the parameter (Pn000) is x.
Pn000.1	Indicates digit 2 of the parameter (Pn000).	Pn000.1 = x or n.□□x□	Indicates that digit 2 of the parameter (Pn000) is x.
Pn000.2	Indicates digit 3 of the parameter (Pn000).	Pn000.2 = x or n.□x□□	Indicates that digit 3 of the parameter (Pn000) is x.
Pn000.3	Indicates digit 4 of the parameter (Pn000).	Pn000.3 = x or n.x□□□	Indicates that digit 4 of the parameter (Pn000) is x.

- Manuals Related to the Σ-V Series

Refer to the following manuals as required.

Name	Selecting Models and Peripheral Devices	Ratings and Specifications	Designing Systems	Panels and Wiring	Trial Operation	Trial Operation and Servo Adjustment	Maintenance and Inspection
Σ-V Series User's Manual Design and Maintenance Rotational Motor Command Option Attachable Type (SIEP S800000 60)		✓			✓	✓	✓
Σ-V Series User's Manual Design and Maintenance Linear Motor Command Option Attachable Type (SIEP S800000 66)		✓			✓	✓	✓
Σ-V Series INDEXER Module Installation Guide (TOBP C720829 02)				✓			
Σ-V Series User's Manual Setup Rotational Motor (SIEP S800000 43)				✓	✓		
Σ-V Series Product Catalog (KAEP S800000 42)	✓	✓	✓				
Σ-V Series User's Manual Operation of Digital Operator (SIEP S800000 55)					✓	✓	✓
Σ-V Series AC SERVOPACK SGD V Safety Precautions (TOBP C710800 10)	✓			✓			✓
Σ Series Digital Operator Safety Precautions (TOBP C730800 00)							✓
AC SERVOMOTOR Safety Precautions (TOBP C230200 00)				✓			✓

■ Safety Information

The following conventions are used to indicate precautions in this manual. Failure to heed precautions provided in this manual can result in serious or possibly even fatal injury or damage to the products or to related equipment and systems.



Indicates precautions that, if not heeded, could possibly result in loss of life or serious injury.



Indicates precautions that, if not heeded, could result in relatively serious or minor injury, damage to the product, or faulty operation. In some situations, the precautions indicated could have serious consequences if not heeded.



Indicates prohibited actions that must not be performed. For example, this symbol would be used to indicate that fire is prohibited as follows:



Indicates compulsory actions that must be performed. For example, this symbol would be used as follows to indicate that grounding is compulsory:



Safety Precautions

These safety precautions are very important. Read them before performing any procedures such as checking products on delivery, storage and transportation, installation, wiring, operation and inspection, or disposal. Be sure to always observe these precautions thoroughly.



WARNING

- Never touch any rotating motor parts while the motor is running.
Failure to observe this warning may result in injury.
- Before starting operation with a machine connected, make sure that an emergency stop can be applied at any time.
Failure to observe this warning may result in injury or damage to the product.
- Never touch the inside of the SERVOPACKs.
Failure to observe this warning may result in electric shock.
- Do not remove the cover of the power supply terminal block while the power is ON.
Failure to observe this warning may result in electric shock.
- After the power is turned OFF or after a voltage resistance test, do not touch terminals while the charge indicator is ON.
Residual voltage may cause electric shock.
- Follow the procedures and instructions provided in the user's manual for the relevant products for trial operation.
Failure to do so may result not only in faulty operation and damage to equipment, but also in personal injury.
- The multi-turn serial data output range for the Σ -V Series absolute position detecting system is different from that of earlier systems with 15-bit and 12-bit encoders. In particular, change the system to configure the Σ Series infinite-length positioning system with the Σ -V Series.
- The multi-turn limit value need not be changed except for special applications.
Changing it inappropriately or unintentionally can be dangerous.
- If the Multi-turn Limit Disagreement alarm occurs, check the setting of parameter Pn205 in the SERVOPACK to be sure that it is correct.
If Fn013 is executed when an incorrect parameter value is set, an incorrect value will be set in the encoder. The alarm will disappear even if an incorrect value is set, but incorrect positions will be detected, resulting in a dangerous situation where the machine will move to unexpected positions.
- Do not remove the front cover, cables, connectors, or optional items from the upper front of the SERVOPACK while the power is ON.
Failure to observe this warning may result in electric shock.
- Do not damage, press, exert excessive force on, or place heavy objects on the cables.
Failure to observe this warning may result in electric shock, stopping operation of the product, or fire.
- Do not modify products.
Failure to observe this warning may result in injury, damage to products or fire.
- Provide an appropriate stopping device on the machine side to ensure safety.
The holding brake on a servomotor with a brake is not a stopping device for ensuring safety.
Failure to observe this warning may result in injury.
- Do not approach the machine when an instantaneous power interruption has occurred because the machine may restart suddenly when the power is recovered. Secure the safety of people around the machine when the machine restarts.
Failure to observe this warning may result in injury.
- Connect the ground terminal according to local electrical codes (100 Ω or less for a SERVOPACK with a 100 V, 200 V power supply, 10 Ω or less for a SERVOPACK with a 400 V power supply).
Improper grounding may result in electric shock or fire.
- Installation, disassembly, or repair must be performed only by authorized personnel.
Failure to observe this warning may result in electric shock or injury.
- The person who designs a system using the safety function (Hard Wire Baseblock function) must have full knowledge of the related safety standards and full understanding of the instructions in this manual.
Failure to observe this warning may result in injury or damage to the product.



■ Storage and Transportation

CAUTION

- Do not store or install the product in the following locations.
Failure to observe this caution may result in fire, electric shock, or damage to the product.
 - Locations subject to direct sunlight
 - Locations subject to ambient operating temperatures outside the range specified in the storage/installation temperature conditions
 - Locations subject to humidity outside the range specified in the storage/installation humidity conditions
 - Locations subject to condensation as the result of extreme changes in temperature
 - Locations subject to corrosive or flammable gases
 - Locations subject to dust, salts, or iron dust
 - Locations subject to exposure to water, oil, or chemicals
 - Locations subject to shock or vibration
- Do not hold the product by the cables, motor shaft or detector while transporting it.
Failure to observe this caution may result in injury or malfunction.
- Do not place any load exceeding the limit specified on the packing box.
Failure to observe this caution may result in injury or malfunction.
- If disinfectants or insecticides must be used to treat packing materials such as wooden frames, pallets, or plywood, the packing materials must be treated before the product is packaged, and methods other than fumigation must be used.
Example: Heat treatment, where materials are kiln-dried to a core temperature of 56°C for 30 minutes or more.
If the electronic products, which include stand-alone products and products installed in machines, are packed with fumigated wooden materials, the electrical components may be greatly damaged by the gases or fumes resulting from the fumigation process. In particular, disinfectants containing halogen, which includes chlorine, fluorine, bromine, or iodine can contribute to the erosion of the capacitors.

■ Installation

CAUTION

- Never use the product in an environment subject to water, corrosive gases, inflammable gases, or combustibles.
Failure to observe this caution may result in electric shock or fire.
- Do not step on or place a heavy object on the product.
Failure to observe this caution may result in injury or malfunction.
- Do not cover the inlet or outlet ports and prevent any foreign objects from entering the product.
Failure to observe this caution may cause internal elements to deteriorate resulting in malfunction or fire.
- Be sure to install the product in the correct direction.
Failure to observe this caution may result in malfunction.
- Provide the specified clearances between the SERVOPACK and the control panel or with other devices.
Failure to observe this caution may result in fire or malfunction.
- Do not apply any strong impact.
Failure to observe this caution may result in malfunction.

■ Wiring



CAUTION

- Be sure to wire correctly and securely.
Failure to observe this caution may result in motor overrun, injury, or malfunction.
- Do not connect a commercial power supply to the U, V, or W terminals for the servomotor connection.
Failure to observe this caution may result in injury or fire.
- Securely connect the main circuit power supply terminal screws, control power supply terminal screws, and servomotor connection terminal screws.
Failure to observe this caution may result in fire.
- Do not bundle or run the main circuit cables together with the input/output signal cables or the encoder cables in the same duct. Keep them separated by at least 30 cm.
Failure to do so may result in malfunction.
- Use shielded twisted-pair wires or multi-core shielded twisted-pair wires for input/output signal cables and the encoder cables.
- I/O signal cables must be no longer than 3 m, encoder cables must be no longer than 50 m, and control power supply cables for the SERVOPACK with a 400 V power supply (+24 V, 0 V) must be no longer than 10 m.
- Do not touch the power terminals while the charge indicator is ON after turning power OFF because high voltage may still remain in the SERVOPACK.
Make sure the charge indicator is OFF first before starting an inspection.
- Observe the following precautions when wiring main circuit terminal blocks of the SERVOPACK.
 - Do not turn ON the power to the SERVOPACK until all the wiring including that to the main circuit terminal blocks has been completed.
 - When the main circuit terminal blocks are connectors, remove the connectors from the SERVOPACK and connect the wires to the connectors.
 - Insert only one main power line per opening in the main circuit terminals.
 - Make sure that no part of the core wire comes into contact with (i.e., short-circuit) adjacent wires.
- Install a battery at either the host controller or the SERVOPACK, but not both.
It is dangerous to install batteries at both ends simultaneously, because that sets up a loop circuit between the batteries.
- Always use the specified power supply voltage.
An incorrect voltage may result in fire or malfunction.
- Take appropriate measures to ensure that the input power supply is supplied within the specified voltage fluctuation range. Be particularly careful in places where the power supply is unstable.
An incorrect power supply may result in damage to the product.
- Install external breakers or other safety devices against short-circuiting in external wiring.
Failure to observe this caution may result in fire.
- Take appropriate and sufficient countermeasures for each form of potential interference when installing systems in the following locations.
 - Locations subject to static electricity or other forms of noise
 - Locations subject to strong electromagnetic fields and magnetic fields
 - Locations subject to possible exposure to radioactivity
 - Locations close to power suppliesFailure to observe this caution may result in damage to the product.
- Do not reverse the polarity of the battery when connecting it.
Failure to observe this caution may damage the battery, the SERVOPACK, the servomotor, or cause an explosion.
Wiring or inspection must be performed by a technical expert.
- Use a 24-VDC power supply with double insulation or reinforced insulation.

■ Operation

CAUTION

- Always use the servomotor and SERVOPACK in one of the specified combinations.
Failure to observe this caution may result in fire or malfunction.
- Conduct trial operation on the servomotor alone with the motor shaft disconnected from the machine to avoid accidents.
Failure to observe this caution may result in injury.
- During trial operation, confirm that the holding brake works correctly. Furthermore, secure system safety against problems such as signal line disconnection.
- Before starting operation with a machine connected, change the settings to match the parameters of the machine.
Starting operation without matching the proper settings may cause the machine to run out of control or malfunction.
- Do not frequently turn power ON and OFF.
Since the SERVOPACK has a capacitor in the power supply, a high charging current flows when power is turned ON. Frequently turning power ON and OFF causes main power devices like capacitors and fuses to deteriorate, resulting in unexpected problems.
- When using JOG operations (Fn002), origin search (Fn003), or EasyFFT operations (Fn206), the dynamic brake function does not work for reverse overtravel or forward overtravel. Take necessary precautions.
Failure to observe this caution may result in damage to the product.
- When using the servomotor for a vertical axis, install safety devices to prevent workpieces from falling due to alarms or overtravels. Set the servomotor so that it will stop in the zero clamp state when overtravel occurs.
Failure to observe this caution may cause workpieces to fall due to overtravel.
- When not using tuning-less function, set to the correct moment of inertia ratio (Pn103).
Setting to an incorrect moment of inertia ratio may cause machine vibration.
- Do not touch the SERVOPACK heatsinks, regenerative resistor, or servomotor while power is ON or soon after the power is turned OFF.
Failure to observe this caution may result in burns due to high temperatures.
- Do not make any extreme adjustments or setting changes of parameters.
Failure to observe this caution may result in injury or damage to the product due to unstable operation.
- When an alarm occurs, remove the cause, reset the alarm after confirming safety, and then resume operation.
Failure to observe this caution may result in damage to the product, fire, or injury.
- Do not use the holding brake of the servomotor for braking.
Failure to observe this caution may result in malfunction.
- An alarm or warning may be generated if communications are executed with the host controller during operation using SigmaWin+ or the digital operator.
If an alarm or warning is generated, the process currently being executed may be aborted and the system may stop.

■ Maintenance and Inspection

CAUTION

- Do not disassemble the SERVOPACK.
Failure to observe this caution may result in electric shock or injury.
- Do not change wiring while the power is ON.
Failure to observe this caution may result in electric shock or injury.
- When replacing the SERVOPACK, resume operation only after copying the previous SERVOPACK parameters to the new SERVOPACK.
Failure to observe this caution may result in damage to the product.

■ Disposal



CAUTION

- When disposing of the products, treat them as ordinary industrial waste.

■ General Precautions

**Observe the following general precautions
to ensure safe application.**

- The products shown in illustrations in this manual are sometimes shown without covers or protective guards. Always replace the cover or protective guard as specified first, and then operate the products in accordance with the manual.
- The drawings presented in this manual are typical examples and may not match the product you received.
- If the manual must be ordered due to loss or damage, inform your nearest Yaskawa representative or one of the offices listed on the back of this manual.

Warranty

(1) Details of Warranty

■ Warranty Period

The warranty period for a product that was purchased (hereinafter called “delivered product”) is one year from the time of delivery to the location specified by the customer or 18 months from the time of shipment from the Yaskawa factory, whichever is sooner.

■ Warranty Scope

Yaskawa shall replace or repair a defective product free of charge if a defect attributable to Yaskawa occurs during the warranty period above. This warranty does not cover defects caused by the delivered product reaching the end of its service life and replacement of parts that require replacement or that have a limited service life.

This warranty does not cover failures that result from any of the following causes.

1. Improper handling, abuse, or use in unsuitable conditions or in environments not described in product catalogs or manuals, or in any separately agreed-upon specifications
2. Causes not attributable to the delivered product itself
3. Modifications or repairs not performed by Yaskawa
4. Abuse of the delivered product in a manner in which it was not originally intended
5. Causes that were not foreseeable with the scientific and technological understanding at the time of shipment from Yaskawa
6. Events for which Yaskawa is not responsible, such as natural or human-made disasters

(2) Limitations of Liability

1. Yaskawa shall in no event be responsible for any damage or loss of opportunity to the customer that arises due to failure of the delivered product.
2. Yaskawa shall not be responsible for any programs (including parameter settings) or the results of program execution of the programs provided by the user or by a third party for use with programmable Yaskawa products.
3. The information described in product catalogs or manuals is provided for the purpose of the customer purchasing the appropriate product for the intended application. The use thereof does not guarantee that there are no infringements of intellectual property rights or other proprietary rights of Yaskawa or third parties, nor does it construe a license.
4. Yaskawa shall not be responsible for any damage arising from infringements of intellectual property rights or other proprietary rights of third parties as a result of using the information described in catalogs or manuals.

(3) Suitability for Use

1. It is the customer's responsibility to confirm conformity with any standards, codes, or regulations that apply if the Yaskawa product is used in combination with any other products.
2. The customer must confirm that the Yaskawa product is suitable for the systems, machines, and equipment used by the customer.
3. Consult with Yaskawa to determine whether use in the following applications is acceptable. If use in the application is acceptable, use the product with extra allowance in ratings and specifications, and provide safety measures to minimize hazards in the event of failure.
 - Outdoor use, use involving potential chemical contamination or electrical interference, or use in conditions or environments not described in product catalogs or manuals
 - Nuclear energy control systems, combustion systems, railroad systems, aviation systems, vehicle systems, medical equipment, amusement machines, and installations subject to separate industry or government regulations
 - Systems, machines, and equipment that may present a risk to life or property
 - Systems that require a high degree of reliability, such as systems that supply gas, water, or electricity, or systems that operate continuously 24 hours a day
 - Other systems that require a similar high degree of safety
4. Never use the product for an application involving serious risk to life or property without first ensuring that the system is designed to secure the required level of safety with risk warnings and redundancy, and that the Yaskawa product is properly rated and installed.
5. The circuit examples and other application examples described in product catalogs and manuals are for reference. Check the functionality and safety of the actual devices and equipment to be used before using the product.
6. Read and understand all use prohibitions and precautions, and operate the Yaskawa product correctly to prevent accidental harm to third parties.

(4) Specifications Change

The names, specifications, appearance, and accessories of products in product catalogs and manuals may be changed at any time based on improvements and other reasons. The next editions of the revised catalogs or manuals will be published with updated code numbers. Consult with your Yaskawa representative to confirm the actual specifications before purchasing a product.

Applicable Standards

■ North American Safety Standards (UL)

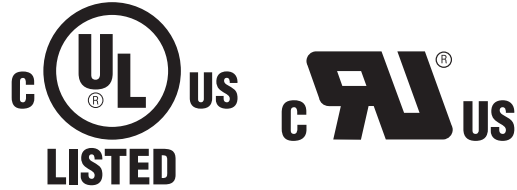

	Model	UL* Standards (UL File No.)
SERVOPACK	• SGDV	UL508C (E147823)
Servomotor	• SGMJV • SGMAV • SGMPS • SGMGV • SGMSV	UL1004 (E165827)

* Underwriters Laboratories Inc.

Note: Applicable when the INDEXER Module is attached to the SERVOPACKs for the command option attachable type.

■ European Standards



	Model	Low Voltage Directive	EMC Directive		Safety Standards
			EMI	EMS	
SERVOPACK	• SGDV	EN50178 EN61800-5-1	EN55011/A2 group 1 class A EN61800-3	EN61800-3 EN61000-6-2	EN954-1 IEC61508-1 to 4
Servomotor	• SGMJV • SGMAV • SGMPS • SGMGV • SGMSV	IEC60034-1 IEC60034-5 IEC60034-8 IEC60034-9	EN55011/A2 group 1 class A EN61800-3	EN61800-3 EN61000-6-2	—

Note 1. Because SERVOPACKs and servomotors are built into machines, certification is required after installation in the final product.

2. Applicable when the INDEXER Module is attached to SERVOPACKs for the command option attachable type.

Contents

About this Manual	iii
Safety Precautions.....	vi
Warranty.....	xi
Applicable Standards.....	xiii
Chapter 1 Overview.....	1-1
1.1 Checking Products on Delivery	1-2
1.2 Nameplate and Model Designation	1-3
1.3 Nameplate Location	1-4
Chapter 2 Specifications	2-1
2.1 Product Overview	2-2
2.1.1 Main Functions.....	2-2
2.1.2 Features of Firmware Versions	2-3
2.2 General Specifications	2-4
2.3 Part Names of the INDEXER Module.....	2-5
2.4 LED Indicators	2-6
Chapter 3 SERVOPACK Installation	3-1
3.1 SERVOPACK Installation Environment and Applicable Standards	3-2
3.1.1 Installation Environment.....	3-2
3.1.2 Installation Conditions for Applicable Standards	3-2
3.2 SERVOPACK Installation	3-3
3.2.1 Orientation	3-3
3.2.2 Installation Standards.....	3-4
3.3 EMC Installation Conditions	3-5
Chapter 4 Wiring and Connection	4-1
4.1 System Configuration Diagram	4-2
4.1.1 Connecting to SGD V-□□□FE1A SERVOPACK	4-2
4.1.2 Connecting to SGD V-□□□AE1A SERVOPACK.....	4-3
4.1.3 Connecting to SGD V-□□□DE1A SERVOPACK.....	4-5
4.1.4 Connecting to SGD V-□□□FE5A SERVOPACK	4-6
4.1.5 Connecting to SGD V-□□□AE5A SERVOPACK.....	4-7
4.1.6 Connecting to SGD V-□□□DE5A SERVOPACK.....	4-9
4.2 I/O Signal Connections.....	4-10
4.2.1 I/O Signal Names and Functions	4-10
4.2.2 Interface Circuits	4-14
4.2.3 Example of I/O Signal Connections	4-15
4.3 Serial Command Communications Connector (CN12).....	4-17
4.3.1 Communications Specifications	4-17
4.3.2 Communications Connector.....	4-18
4.3.3 Connector Signal Names	4-18
4.3.4 Connection Examples	4-19
4.3.5 RS-422/RS-485 Interface.....	4-20
4.4 Power Loss in the INDEXER Module.....	4-21

Chapter 5 Parameter Setting and Functions	5-1
5.1 Parameter Configurations	5-2
5.2 Restrictions on SGDV SERVOPACK Parameters	5-3
5.3 Sequence I/O Signals	5-5
5.3.1 Servo ON Signal (/S-ON)	5-5
5.3.2 Overtravel	5-5
5.3.3 Servo Alarm Output Signal (ALM) and Alarm Code Output Signals (/ALO1, /ALO2, and /ALO3)	5-7
5.3.4 Braking Signal (/BK)	5-8
5.3.5 Servo Ready Output Signal (/S-RDY)	5-9
5.3.6 Error/Warning Output Signal (/WARN)	5-9
5.3.7 Positioning Completed Output Signal (/INPOSITION)	5-10
5.3.8 Programmable Output Signals (/POUT0 to /POUT7)	5-11
5.3.9 Encoder Signal Outputs	5-12
5.4 Settings According to Device Characteristics	5-13
5.4.1 Setting Reference Units	5-13
5.4.2 Moving Mode and Coordinate Settings	5-16
5.4.3 Setting Home Position	5-18
5.4.4 Backlash Compensation	5-19
5.4.5 Torque Limit	5-19
5.4.6 Fully-closed Loop Control	5-20
Chapter 6 Program Table	6-1
6.1 Program Table	6-2
6.1.1 Mode Switch Signal (/MODE 0/1)	6-2
6.1.2 Input Signals for Program Table Operation	6-2
6.1.3 Program Table Step Selection	6-4
6.1.4 Program Table Settings	6-5
6.1.5 Examples of EVENT Conditions	6-8
6.1.6 Program Table Operation	6-9
6.1.7 Status Changes in Program Table Operation	6-10
6.1.8 Input Signal Timing Specifications for Program Table Operation	6-11
6.1.9 Response Times after Turning ON the /START-STOP Signal	6-12
6.1.10 Program Table Examples	6-13
6.2 Registration	6-19
6.2.1 Registration Timing Specifications	6-19
6.2.2 Registration Input Setting	6-20
6.2.3 Registration Operation	6-20
6.3 ZONE Table Settings	6-22
6.4 Homing/JOG Speed Table	6-24
6.4.1 Mode Switch Input Signal (/MODE 0/1)	6-24
6.4.2 Homing/JOG Speed Table Input Signals	6-24
6.4.3 Parameters Related to Homing	6-26
6.5 Homing	6-27
6.6 JOG Speed Table Operation	6-28
6.6.1 Example of JOG Speed Table Operation	6-28
6.6.2 JOG Speed Table	6-29
6.6.3 Input Conditions for Homing and JOG Speed Table Operation	6-30
6.6.4 Input Signal Timing Specifications for Homing and JOG Speed Table Operation	6-30

Chapter 7 Serial Command Communications	7-1
7.1 CN12 Connector Specifications	7-2
7.2 Settings	7-3
7.2.1 Block Diagram	7-3
7.2.2 Setting the Axis Address	7-3
7.2.3 Parameters Related to Serial Communications	7-3
7.3 Command/Response Format	7-4
7.4 Global Commands	7-5
7.5 Echoback Response Time	7-6
7.6 Response Data Details	7-7
7.6.1 Positive Responses	7-7
7.6.2 Negative Responses	7-7
7.7 Serial Commands	7-8
7.7.1 Basic Operation Commands	7-8
7.7.2 Control Commands	7-9
7.7.3 Parameter Edit Commands	7-22
7.7.4 Program Table Setup Commands	7-24
7.7.5 Program Table Operation Commands	7-28
7.7.6 Zone Table Setup Commands	7-29
7.7.7 JOG Speed Table Setup Commands	7-30
7.7.8 Monitor and Utility Function Commands	7-31
Chapter 8 Operation of Digital Operator	8-1
8.1 Overview	8-2
8.1.1 Functions List	8-2
8.1.2 Changing the Function	8-2
8.1.3 Reading the Screen	8-3
8.2 Operation of Utility Functions	8-4
8.2.1 Utility Functions	8-4
8.2.2 Program Table Edit/Save (FnB03)	8-6
8.2.3 ZONE Table Edit/Save (FnB04)	8-11
8.2.4 JOG Speed Table Edit/Save (FnB05)	8-14
8.2.5 Program Table Initialization (FnB06)	8-16
8.2.6 ZONE Table Initialization (FnB07)	8-17
8.2.7 JOG Speed Table Initialization (FnB08)	8-18
8.2.8 Absolute Encoder Origin Setting (FnB09)	8-19
8.2.9 INDEXER Status Monitor (FnB0A)	8-21
8.2.10 INDEXER Parameter Setting Initialization (FnB0B)	8-24
8.2.11 INDEXER Alarm Reset (FnB0C)	8-25
8.2.12 INDEXER Alarm History Display (FnB0D)	8-27
Chapter 9 Troubleshooting	9-1
9.1 Troubleshooting	9-2
9.1.1 List of Alarms for Command Option Attachable Type SERVOPACKs	9-2
9.1.2 INDEXER Module Alarm Displays and Troubleshooting	9-9
9.2 Warning Displays	9-12
9.2.1 List of Warnings for Command Option Attachable Type SERVOPACKs	9-12
9.2.2 INDEXER Module Error Displays and Troubleshooting	9-14
9.3 Troubleshooting Malfunction Based on Operation and Conditions	9-19

Chapter 10 Appendix	10-1
10.1 Parameter List for INDEXER Module	10-2
10.2 Parameter List for Command Option Attachable Type SERVOPACKs	10-10
10.3 Monitor Modes	10-27
10.4 Utility Functions	10-28
10.5 Alphabetical List of Serial Commands	10-30
10.6 Parameter Equivalence List for INDEXER Modules for SGD V SERVOPACKs and INDEXER Modules for SGD H SERVOPACKs	10-33

Index	Index-1
-----------------	---------

Revision History

Overview

This chapter gives an overview of the INDEXER Module and describes how to check parts upon delivery.

1.1	Checking Products on Delivery	1-2
1.2	Nameplate and Model Designation	1-3
1.3	Nameplate Location	1-4

1.1 Checking Products on Delivery

(1) When the INDEXER Module is Not Connected to the SERVOPACK

1. Mount the INDEXER Module to the SERVOPACK as described in the enclosed *Σ-V Series INDEXER Module Installation Guide* (TOBP C720829 02).
For the location of the nameplate, refer to 1.3 *Nameplate Location*.
2. Check the nameplate to confirm that the product is the one that was ordered.
For the nameplate, refer to 1.2 *Nameplate and Model Designation*.

(2) When the INDEXER Module is Connected to the SERVOPACK

Check the nameplate to confirm that the Module that is mounted is the INDEXER Module.

The nameplate is located in the following position.

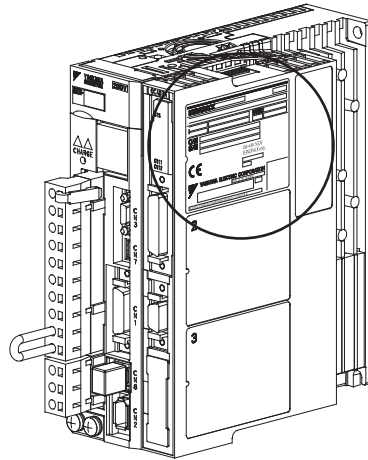

1.2 Nameplate and Model Designation

■ Nameplate Example

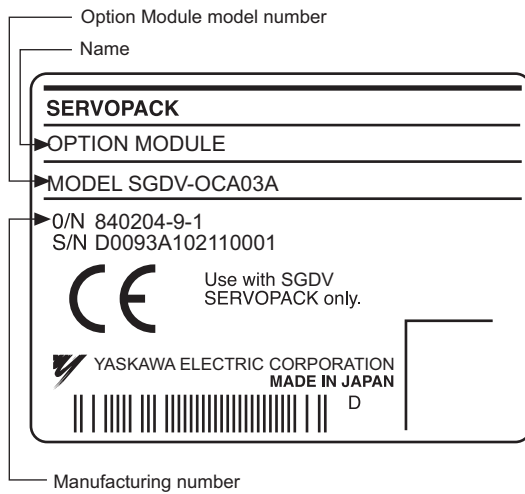

Nameplate

■ Model Designation

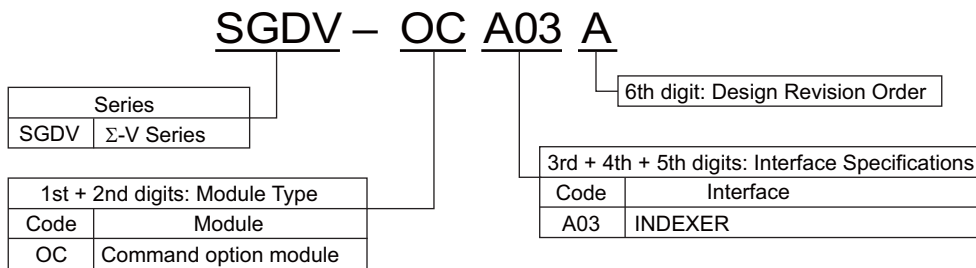

1.3 Nameplate Location

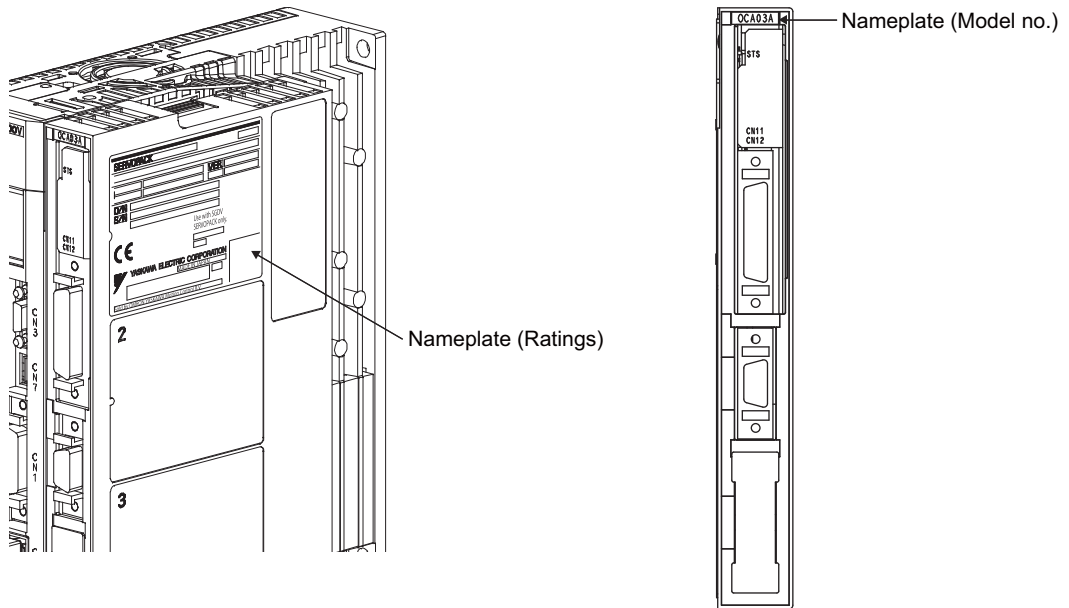

Specifications

This chapter gives an overview and describes the specifications of the INDEXER Module.

2.1 Product Overview	2-2
2.1.1 Main Functions	2-2
2.1.2 Features of Firmware Versions	2-3
2.2 General Specifications	2-4
2.3 Part Names of the INDEXER Module	2-5
2.4 LED Indicators	2-6

2.1 Product Overview

The INDEXER Module is a single-axis positioning device that is equipped with a program table operation function. The INDEXER Module is mounted to the side of the SERVOPACK.

The INDEXER Module has two reference methods: digital I/O and serial commands.

Digital I/O is structured as a program table (Mode 0) or homing/JOG speed table (Mode 1). If the program table (Mode 0) is being used, the program step selected with the input signal pattern (binary format) can be executed. If the JOG speed table (Mode 1) is being used, the JOG speed selected with the input signal pattern (binary format) can be executed.

With serial commands, ASCII command strings are sent to the INDEXER Module through RS-422 or RS-485 communications and these commands are interpreted and executed immediately.

The support software tool, SigmaWin+, can be used to easily set program tables and parameters or to perform monitoring operations.

These same operations can also be performed using serial commands.

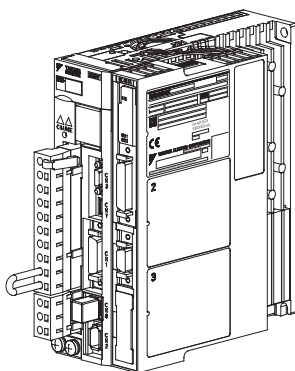

INDEXER Module
Mounted on Σ -V Series SGD V SERVOPACK

2.1.1 Main Functions

Main functions of the INDEXER Module are listed below.

Function	Description
Digital I/O Program Table (Mode 0)	The program step selection input signals (binary format) are used to select the desired positioning data from the program table stored in the INDEXER Module. The INDEXER Module can store up to 256 program steps. The program steps can be linked to create combinations that perform more complex motions.
Digital I/O Homing/JOG Speed Table (Mode 1)	Homing using an incremental encoder and operation using a JOG speed table with up to 16 speed levels can be performed.
Serial Commands	Positioning can be controlled by ASCII command strings received through RS-422 or RS-485 communications. Up to 16 axes can be connected. ASCII commands can also be used to operate using a program table.
Registration	Both the program table and serial commands are equipped with registration functions for external positioning.
Programmable Output Signals	There are 8 output signals (/POUT0 to /POUT7) for which the output status can be specified.
Zone Signals and Zone Table	The programmable output signals (/POUT0 to /POUT4) can also be used as zone signals. Up to 32 zones can be specified in the zone table.

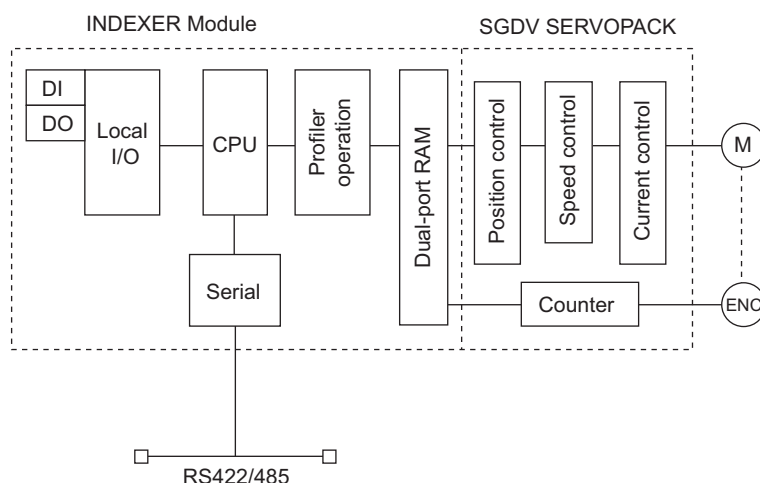

Block Diagram

2.1.2 Features of Firmware Versions

The table below lists the differences between firmware versions for the INDEXER Module. Some functions are included in every version, and have upward compatibility.

Features	Firmware	
	Version 1	Version 3
Fully-closed loop control	Cannot be supported. The fully-closed loop control option is not provided in the parameter Pn002 (External Encoder Usage).	Can be supported when the INDEXER Module is used with the option module for fully-closed loop control.
Use with a linear SERVOPACK	Cannot be supported.	Can be supported.
Serial commands <ul style="list-style-type: none"> • RES command • IN3 command • HBB response of ALM command 	Not supported	Supported
Version mismatch alarms (E13A, E15A, E1AA, E1DA, and E21A)	Not supported	Supported
View status of overtravel and software limit functions on digital operator	Not supported	Supported*
Utility functions of digital operator (FnB03 to FnB0D)	Not supported	Supported*
Version number display <ul style="list-style-type: none"> • Serial command VER • Digital operator Fn12 • SigmaWin+ product information 	Displays 0001.	Displays 0003.
SigmaWin+	Full support for SigmaWin+ version 5.30 or later	Full support for SigmaWin+ version 5.33 or later

* These functions are supported by SERVOPACK software version 001B or later.

2.2 General Specifications

This table lists the general specifications of the INDEXER Module.

Applicable SERVOPACK		Σ-V Series SGD V-□□□□E SERVOPACK, all models	
Placement		Attached to the SERVOPACK	
Power Specifications	Power Supply Method	Supplied from the control power supply of the SGD V SERVOPACK.	
Operating Conditions	Surrounding Air/Storage Temperature	0°C to +55°C/ -20°C to +85°C	
	Ambient/Storage Humidity	90% RH or less (with no condensation)	
	Vibration/Shock Resistance	4.9 m/s ² / 19.6 m/s ²	
	Protection Class/ Pollution Degree	Protection class: IP10, Pollution degree: 2 An environment that satisfies the following conditions. <ul style="list-style-type: none"> • Free of corrosive or explosive gases • Free of exposure to water, oil or chemicals • Free of dust, salts or iron dust 	
	Altitude	1000 m or less	
	Others	Free of static electricity, strong electromagnetic fields, magnetic fields or exposure to radioactivity	
Control Method	Program Table Method	Program table positioning in which steps are executed sequentially by commands given through contact input or serial communications Positioning in which station numbers are specified by commands given through contact input or serial communications	
		Max. Number of Steps	256
		Max. Number of Tables	256
	Max. Number of Stations	256	
Serial Communications Method	Serial command by 1-channel ASCII code Communications specifications: RS-422/485 (50 m max.) Connection topology: Multi-drop connection (16 axes max.) Baud rate: 9600, 19200, 38400 bps		
Other Functions		Registration (positioning by external signals), homing	
Display Function	LED	Lit during parameter setting, monitoring, executing utility functions, etc.	
Applicable Standards*		UL508C, EN50178, EN61800-5-1, EN55011 group 1 class A EN61800-3, EN61000-6-2	

* Applicable when the INDEXER Module is attached to the command option attachable type SERVOPACKs.

2.3 Part Names of the INDEXER Module

The following figure shows the part names of the INDEXER Module.

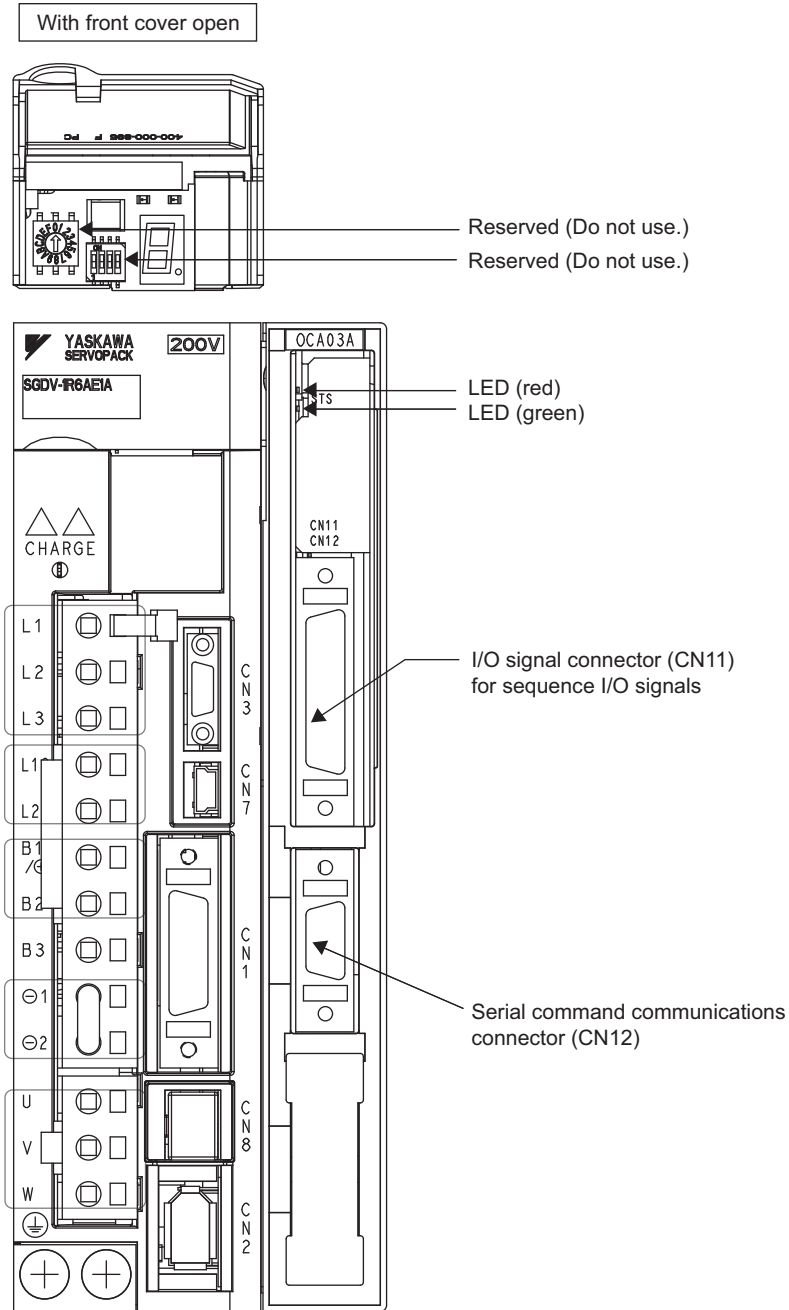

2.4 LED Indicators

The following table shows the meaning of the LED indicators.

Status	Red LED	Green LED
Control Power Supply OFF	Not lit	Not lit
Control Power Supply ON	Not lit	Flashing
Normal	Not lit	Lit
Overtravel/Software Limit Activated		
Resetting	-	Flashing
Saving a Table		
Initializing a Table		
Initializing Parameters		
Error	Flashing (2 seconds)	-
Warning	Flashing	-
Alarm	Lit	Not lit

SERVOPACK Installation

This chapter describes how to install the SERVOPACK.

3.1	SERVOPACK Installation Environment and Applicable Standards	3-2
3.1.1	Installation Environment	3-2
3.1.2	Installation Conditions for Applicable Standards	3-2
3.2	SERVOPACK Installation	3-3
3.2.1	Orientation	3-3
3.2.2	Installation Standards	3-4
3.3	EMC Installation Conditions	3-5

3.1 SERVOPACK Installation Environment and Applicable Standards

SERVOPACK installation environment and applicable standards are as follows.

3.1.1 Installation Environment

- Surrounding air temperature: 0°C to 55°C
- Ambient humidity: 90% RH or less (with no condensation)
- Altitude: 1,000 m or less
- Vibration resistance: 4.9 m/s²
- Shock resistance: 19.6 m/s²
- Installation Precautions

- Mounting in a Control Panel

To prevent the temperature around the SERVOPACK from exceeding 55°C, take into account the size of the control panel, the layout of the SERVOPACK, and the cooling method. For details, refer to 3.2 *SERVOPACK Installation*.

- Mounting Near a Heating Unit

To prevent the temperature around the SERVOPACK from exceeding 55°C, suppress radiant heat from the heating unit and temperature rise due to convection.

- Mounting Near a Vibration Source

To prevent vibration from being transmitted to the SERVOPACK, install a vibration isolator underneath the SERVOPACK.

- Mounting to a Location Exposed to Corrosive Gas

Take measures to prevent exposure to corrosive gas. Corrosive gases will not immediately affect the SERVOPACK, but will eventually cause electronic components and contactor-related devices to malfunction.

- Other Locations

Do not mount the SERVOPACK in locations subject to high temperatures, high humidity, dripping water, cutting oil, dust, iron filings, or radiation.

<Note>

When storing the SERVOPACK with the power OFF, store it in an environment with the following temperature and humidity:

- -20°C to +85°C, 90% RH or less (with no condensation)

3.1.2 Installation Conditions for Applicable Standards

Applicable Standards	UL508C EN50178, EN55011/A2 group1 classA, EN61000-6-2, EN61800-3, EN61800-5-1, EN954-1, IEC61508-1 to 4
Operating Conditions	Overvoltage category:III Pollution degree: 2 Protection class: IP10
Installation Conditions	UL Standard and Low Voltage Directive: Satisfy the conditions outlined in <i>Σ-V Series AC SERVOPACK SGDV Safety Precautions</i> (TOBP C710800 10) EMC Directive: Certification is required after installation in the user's machine under the conditions outlined in 3.3 <i>EMC Installation Conditions</i> .

3.2 SERVOPACK Installation

3.2.1 Orientation

The SERVOPACK is available in models that are base-mounted, models that are rack-mounted, and models that are duct-ventilated. In any case, mount the SERVOPACK with a vertical orientation.

Firmly secure the SERVOPACK to the mounting surface, using either two to four mounting holes depending on the SERVOPACK capacity.

- Base-mounted

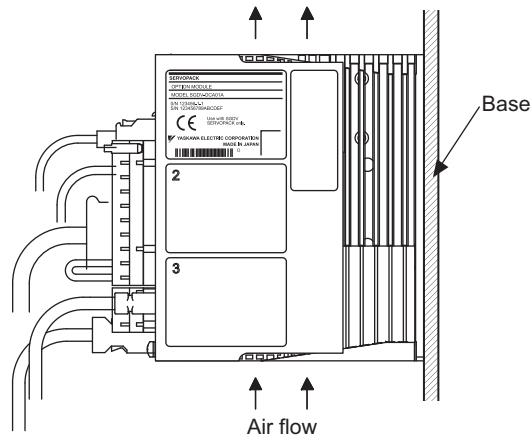

- Rack-mounted

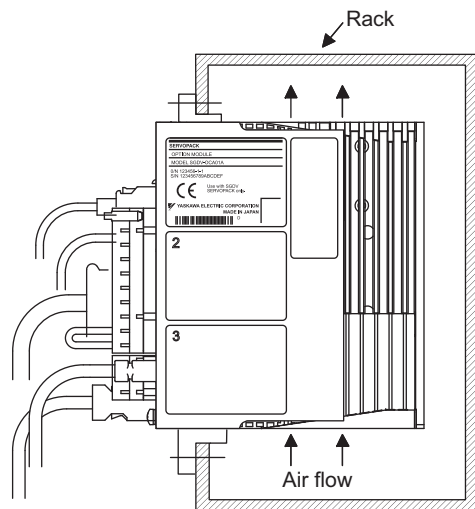

- Duct-ventilated

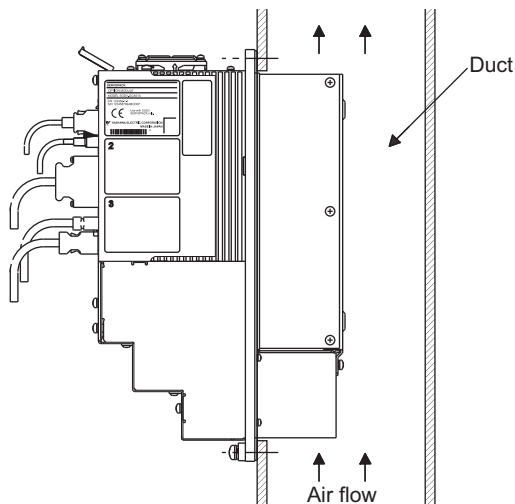

3.2.2 Installation Standards

Observe the standards for mounting SERVOPACKs in control panels, including those for the mounting SERVOPACKs side by side in one control panel as shown in the following illustration.

- **SERVOPACK Mounting Orientation**

Mount the SERVOPACK vertically to the base, with the front panel (the side with the panel operator display) facing out.

- **Cooling**

Refer to the following diagram and leave sufficient space for cooling by fans and natural convection.

- **Mounting SERVOPACKs Side by Side in a Control Panel**

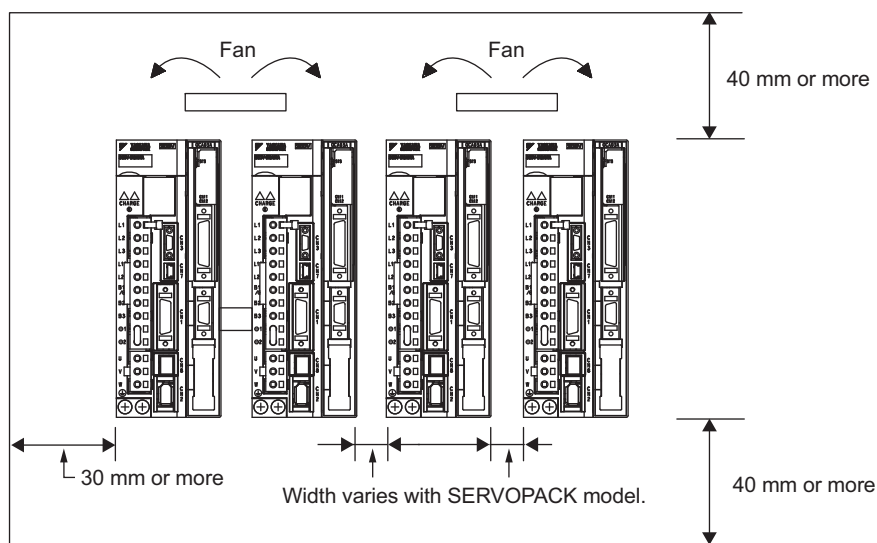

Leave sufficient space on each side and at the top and the bottom of each SERVOPACK. The width on each side varies in accordance with the models of the SERVOPACKs used.

SERVOPACK Model SGDV-	Side		Top and Bottom
	Left	Right	
R70F, R90F, 2R1F, R70A, R90A, 1R6A, 2R8A	1 mm or more		40 mm or more
2R8F, 3R8A, 5R5A, 7R6A	1 mm or more	10 mm or more	
120A, 180A, 200A, 330A, 470A, 550A, 590A, 780A, 1R9D, 3R5D, 5R4D, 8R4D, 120D, 170D, 210D, 260D, 280D, 370D	10 mm or more		

Also install cooling fans above the SERVOPACKs to disperse local pockets of warmer air around the SERVOPACKs.

- **Inside the Control Panel**

The conditions inside the control panel should be the same as the environmental conditions of the SERVOPACK. Refer to 3.1.1 *Installation Environment*.

3.3 EMC Installation Conditions

This section describes the recommended installation conditions that satisfy EMC guidelines for each model of the SGD V SERVOPACK. The conditions required for the standard type (base-mounted) of SERVOPACK are described. Refer to this section for other SERVOPACK models such as the rack-mounted types as well.

This section describes the EMC installation conditions satisfied in test conditions prepared by Yaskawa. The actual EMC level may differ depending on the actual system's configuration, wiring, and other conditions. However, because this product is built into machines, check that the following conditions are still met after being installed in the user's product.

The applicable standards are EN55011/A2 group 1 class A, EN61800-3, and EN61000-6-2.

■ Single-phase 100 V

- SGD V-□□□FE1A (□□□ = R70, R90, 2R1, 2R8) + SGD V-OCA03A
- SGD V-□□□FE5A (□□□ = R70, R90, 2R1, 2R8) + SGD V-OCA03A

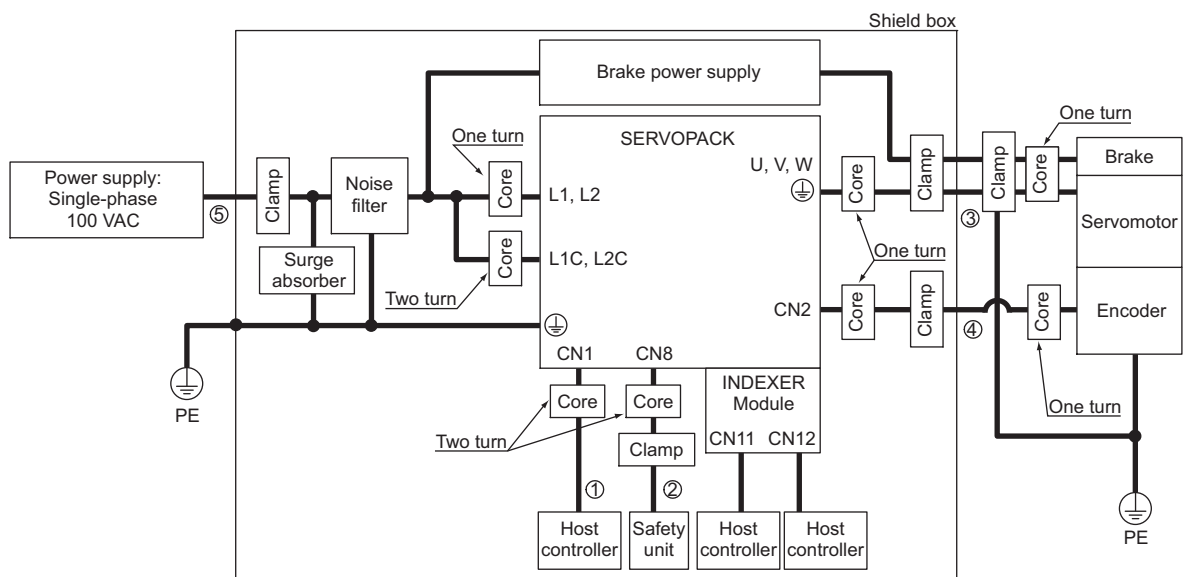

Symbol	Cable Name	Specifications
①	I/O signal cable	Shielded cable
②	Safety signal cable	Shielded cable
③	Motor main circuit cable	Shielded cable
④	Encoder cable	Shielded cable
⑤	Main circuit cable	Shielded cable

■ Three-phase 200 V

- SGD7-□□□AE1A (□□□ = R70, R90, 1R6, 2R8, 3R8, 5R5, 7R6) + SGD7-OCA03A
- SGD7-□□□AE5A (□□□ = R70, R90, 1R6, 2R8, 3R8, 5R5, 7R6) + SGD7-OCA03A

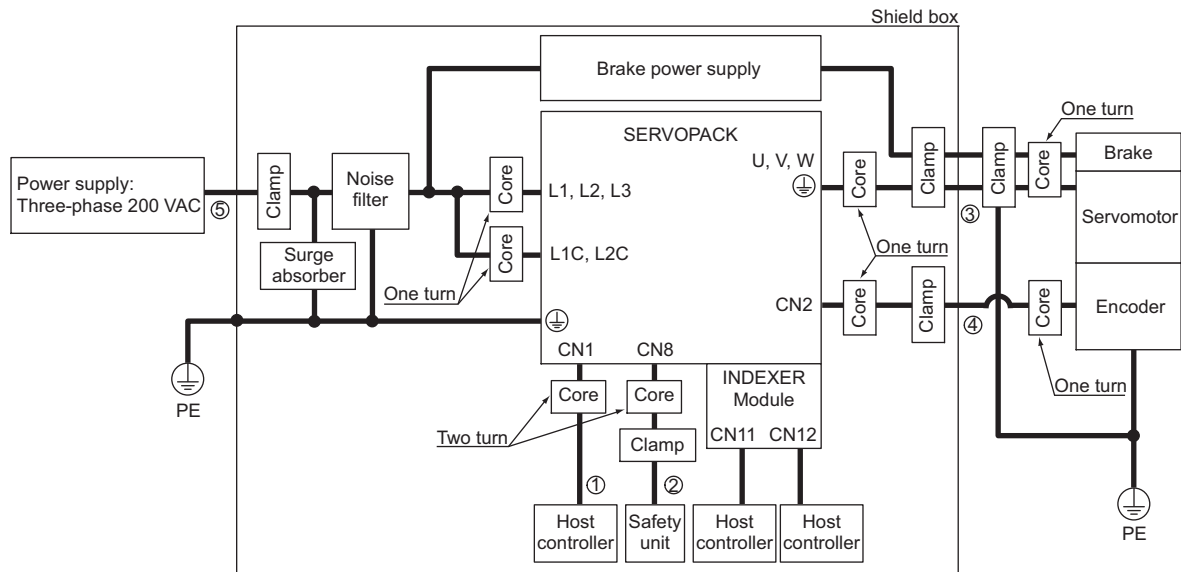

Symbol	Cable Name	Specifications
①	I/O signal cable	Shielded cable
②	Safety signal cable	Shielded cable
③	Motor main circuit cable	Shielded cable
④	Encoder cable	Shielded cable
⑤	Main circuit cable	Shielded cable

■ Three-phase 200 V

- SGDV-□□□AE1A (□□□ = 120) + SGDV-OCA03A
- SGDV-□□□AE5A (□□□ = 120) + SGDV-OCA03A

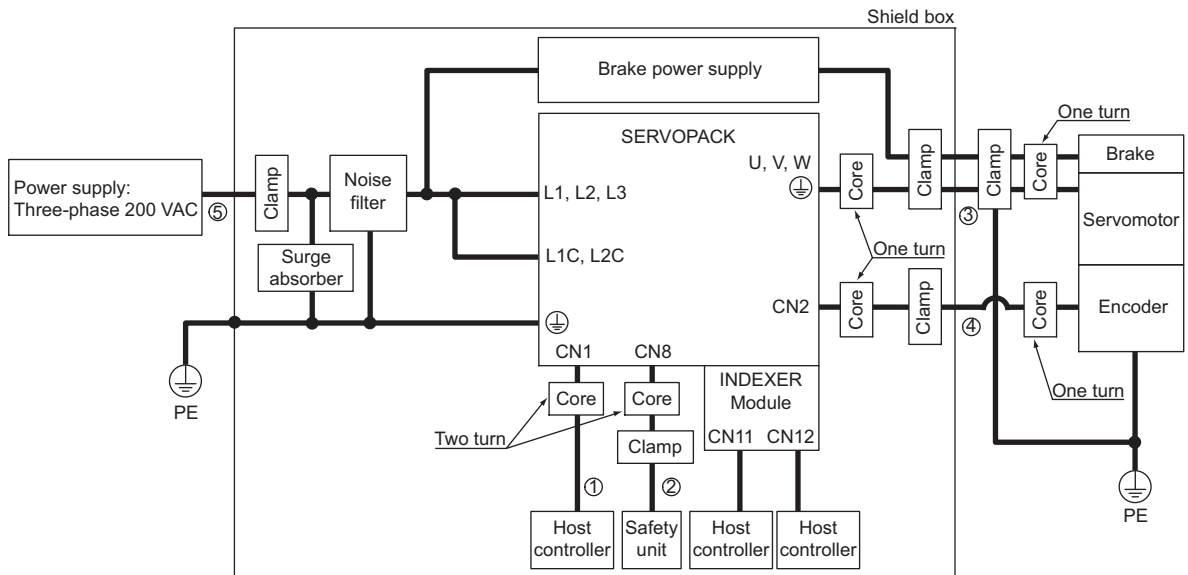

Symbol	Cable Name	Specifications
①	I/O signal cable	Shielded cable
②	Safety signal cable	Shielded cable
③	Motor main circuit cable	Shielded cable
④	Encoder cable	Shielded cable
⑤	Main circuit cable	Shielded cable

■ Three-phase 200 V

- SGDV-□□□AE1A (□□□ = 180, 200, 330) + SGDV-OCA03A
- SGDV-□□□AE5A (□□□ = 180, 200, 330) + SGDV-OCA03A

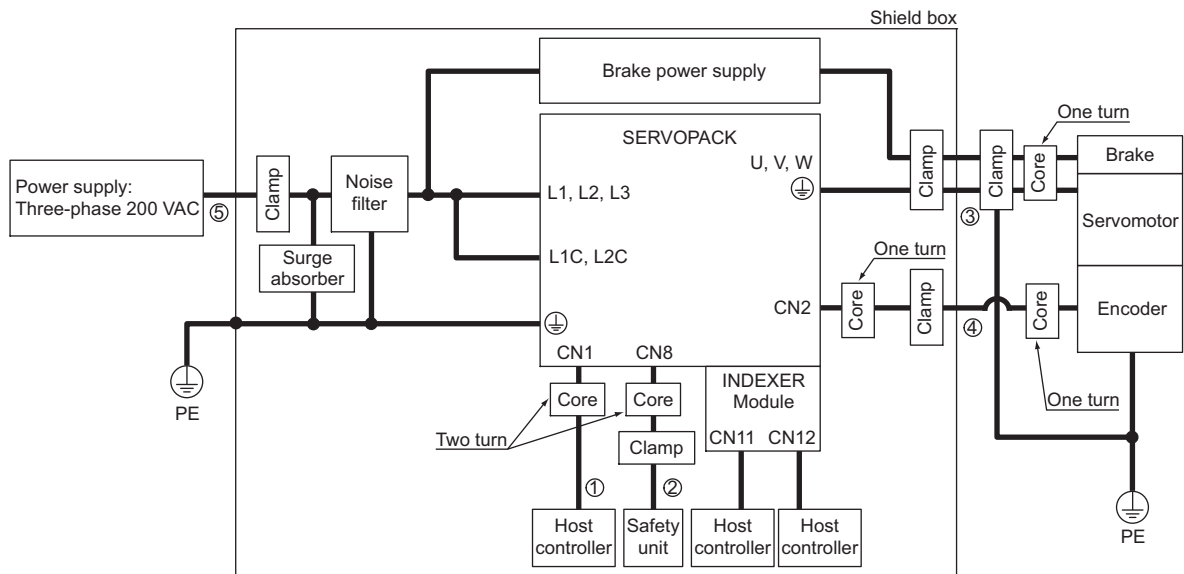

Symbol	Cable Name	Specifications
①	I/O signal cable	Shielded cable
②	Safety signal cable	Shielded cable
③	Motor main circuit cable	Shielded cable
④	Encoder cable	Shielded cable
⑤	Main circuit cable	Shielded cable

■ Three-phase 200 V

- SGDV-□□□AE1A (□□□ = 470, 550, 590, 780) + SGDV-OCA03A
- SGDV-□□□AE5A (□□□ = 470, 550, 590, 780) + SGDV-OCA03A

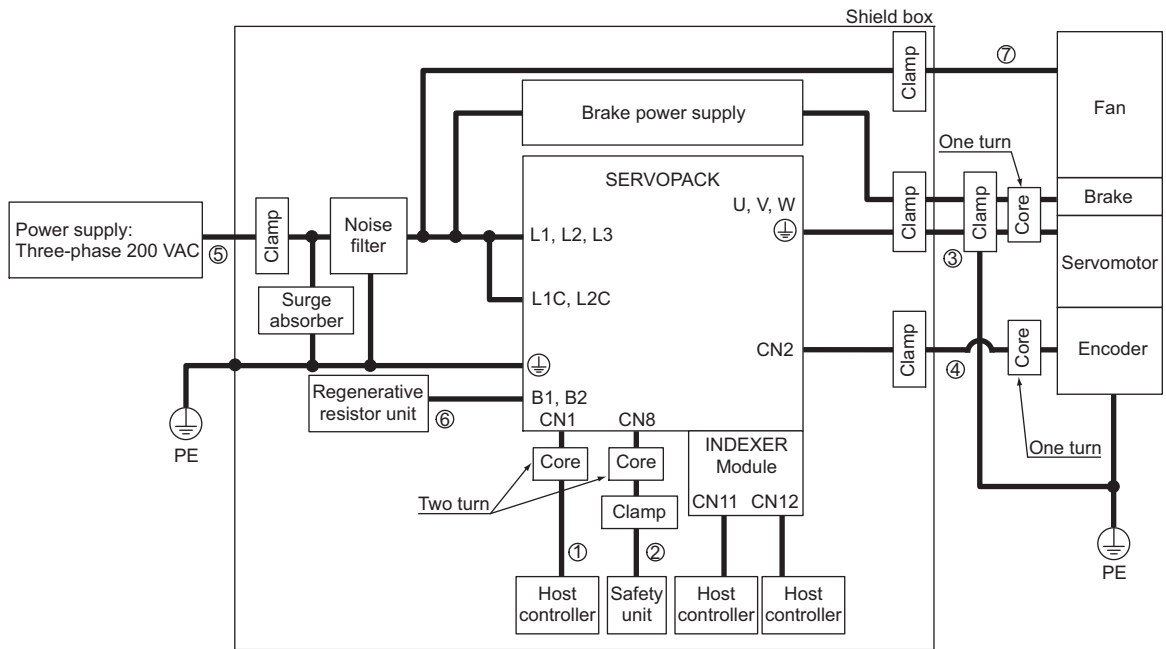

Symbol	Cable Name	Specifications
①	I/O signal cable	Shielded cable
②	Safety signal cable	Shielded cable
③	Motor main circuit cable	Shielded cable
④	Encoder cable	Shielded cable
⑤	Main circuit cable	Shielded cable
⑥	Regenerative resistor unit cable	Non-shielded cable
⑦	Cooling fan cable	Shielded cable

■ Three-phase 400 V

- SGDV-□□□DE1A (□□□ = 1R9, 3R5, 5R4, 8R4, 120, 170) + SGDV-OCA03A
- SGDV-□□□DE5A (□□□ = 1R9, 3R5, 5R4, 8R4, 120, 170) + SGDV-OCA03A

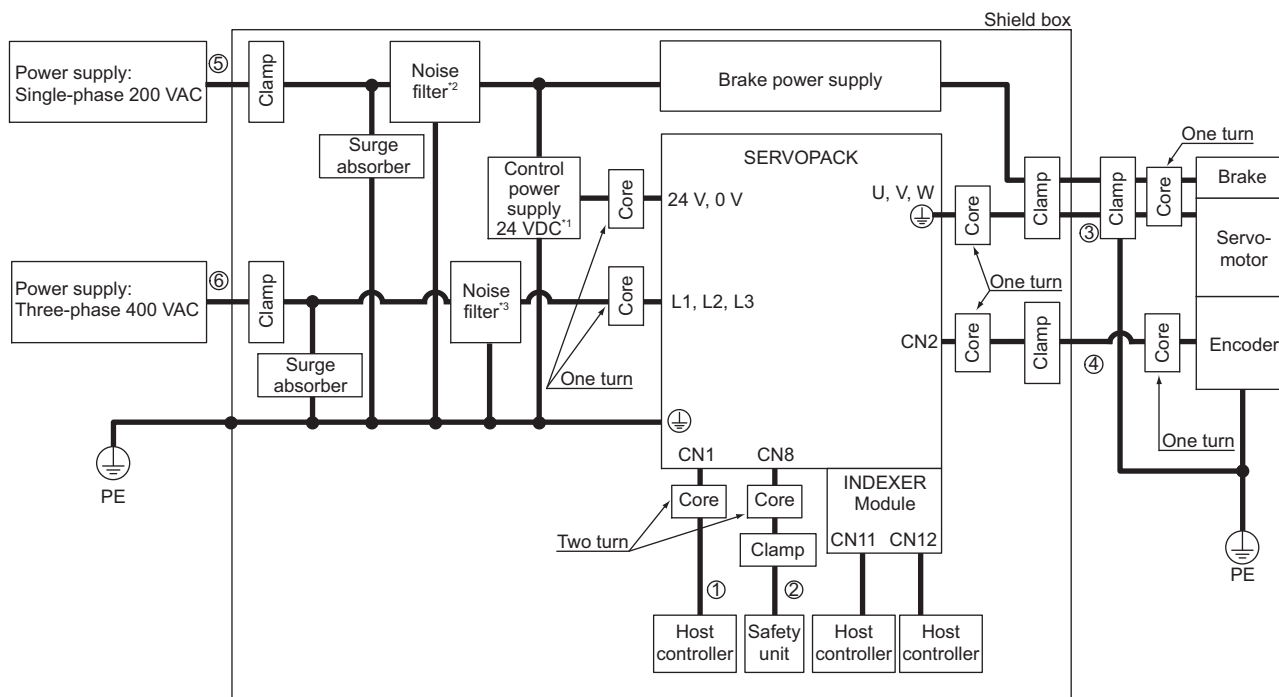

Symbol	Cable Name	Specifications
①	I/O signal cable	Shielded cable
②	Safety signal cable	Shielded cable
③	Motor main circuit cable	Shielded cable
④	Encoder cable	Shielded cable
⑤	Control power cable	Shielded cable
⑥	Main circuit cable	Shielded cable

- *1. Products that have received CE marking are recommended for the 24 VDC power supply.
- *2. Install the following noise filter on the power line between the single-phase 200 V power supply and the 24 VDC power supply.
Model number: FN2070-6/07 (SCHAFFNER)
- *3. For more information on this filter, refer to *Σ-V Series Product Catalog* (KAEP S800000 42).

■ Three-phase 400 V

- SGDV-□□□DE1A (□□□ = 210, 260, 280, 370) + SGDV-OCA03A
- SGDV-□□□DE5A (□□□ = 210, 260, 280, 370) + SGDV-OCA03A

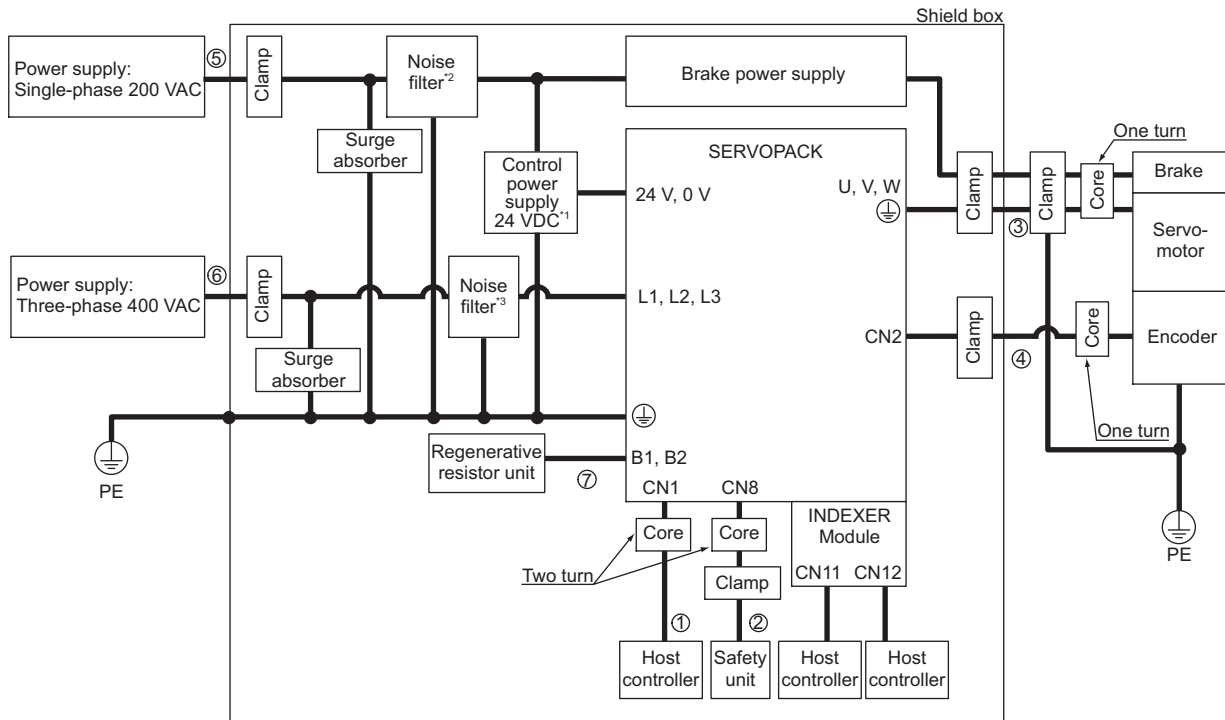

Symbol	Cable Name	Specifications
①	I/O signal cable	Shielded cable
②	Safety signal cable	Shielded cable
③	Motor main circuit cable	Shielded cable
④	Encoder cable	Shielded cable
⑤	Control power cable	Shielded cable
⑥	Main circuit cable	Shielded cable
⑦	Regenerative resistor unit cable	Non-shielded cable

- *1. Products that have received CE marking are recommended for the 24 VDC power supply.
- *2. Install the following noise filter on the power line between the single-phase 200 V power supply and the 24 VDC power supply.
Model number: FN2070-6/07 (SCHAFFNER)
- *3. For more information on this filter, refer to *Σ-V Series Product Catalog* (KAEP S800000 42).

Wiring and Connection

This chapter describes examples of how a system is configured using the INDEXER Module and how the I/O signals are connected.

For details on the main circuit, encoders, safety devices, and regenerative resistors, refer to the following manual.

For more information on safe and stable usage of the servo system, be sure to read the precautions in the section labeled, "⚠ IMPORTANT," in the following manuals.

- Σ -V Series User's Manual Design and Maintenance
Rotational Motor/ Command Option Attachable Type
Chapter 3 Wiring and Connection (SIEP S800000 60)
- Σ -V Series User's Manual Design and Maintenance
Linear Motor/ Command Option Attachable Type
Chapter 3 Wiring and Connection (SIEP S800000 66)

4.1 System Configuration Diagram	4-2
4.1.1 Connecting to SGDV-□□□FE1A SERVOPACK	4-2
4.1.2 Connecting to SGDV-□□□AE1A SERVOPACK	4-3
4.1.3 Connecting to SGDV-□□□DE1A SERVOPACK	4-5
4.1.4 Connecting to SGDV-□□□FE5A SERVOPACK	4-6
4.1.5 Connecting to SGDV-□□□AE5A SERVOPACK	4-7
4.1.6 Connecting to SGDV-□□□DE5A SERVOPACK	4-9
4.2 I/O Signal Connections	4-10
4.2.1 I/O Signal Names and Functions	4-10
4.2.2 Interface Circuits	4-14
4.2.3 Example of I/O Signal Connections	4-15
4.3 Serial Command Communications Connector (CN12)	4-17
4.3.1 Communications Specifications	4-17
4.3.2 Communications Connector	4-18
4.3.3 Connector Signal Names	4-18
4.3.4 Connection Examples	4-19
4.3.5 RS-422/RS-485 Interface	4-20
4.4 Power Loss in the INDEXER Module	4-21

4.1 System Configuration Diagram

Examples of basic servo system configurations are shown for each SERVOPACK type.

4.1.1 Connecting to SGDV-□□□FE1A SERVOPACK

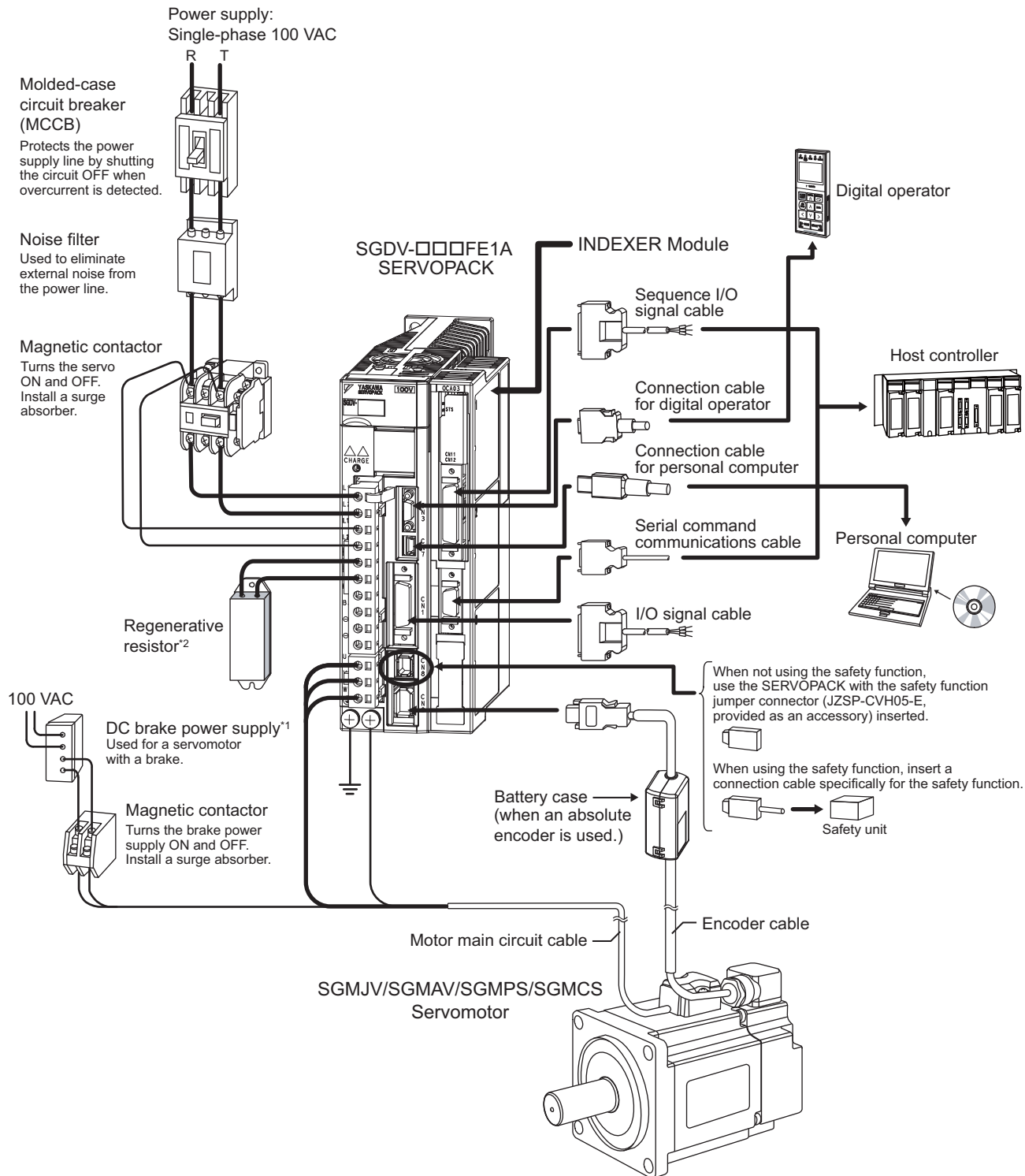

*1. Use a 24-VDC power supply. (not included.)

*2. Before connecting an external regenerative resistor to the SERVOPACK, refer to *Σ-V Series User's Manual Design and Maintenance Rotational Motor/Command Option Attachable Type* (SIEP S800000 60).

Note: The connections and wiring of the power supply of the main circuit and that of the controls differ in accordance with the SERVOPACK to be used. For details, refer to *Σ-V Series User's Manual Design and Maintenance Rotational Motor/Command Option Attachable Type* (SIEP S800000 60).

4.1.2 Connecting to SGDV-□□□AE1A SERVOPACK

(1) Using a Three-phase, 200 V Power Supply

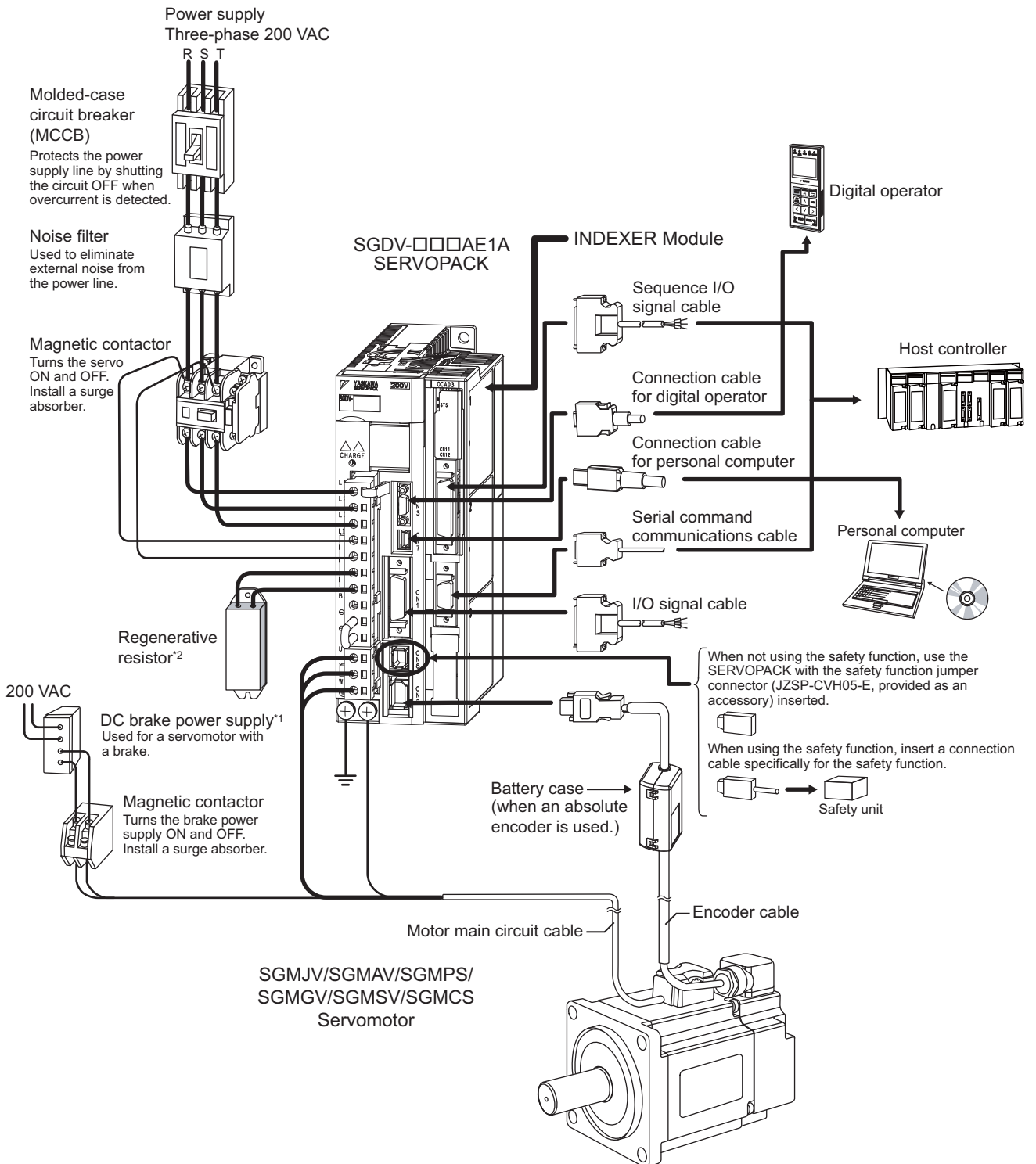

*1. Use a 24-VDC power supply. (not included.)

*2. Before connecting an external regenerative resistor to the SERVOPACK, refer to *Σ-V Series User's Manual Design and Maintenance Rotational Motor/Command Option Attachable Type* (SIEP S800000 60).

Note: The connections and wiring of the power supply of the main circuit and that of the controls differ in accordance with the SERVOPACK to be used. For details, refer to *Σ-V Series User's Manual Design and Maintenance Rotational Motor/Command Option Attachable Type* (SIEP S800000 60).

(2) Using a Single-phase, 200 V Power Supply

The Σ -V Series SERVOPACK for a 200-V power supply input has input specifications for a three-phase power supply, but some models can also be used with a single-phase 200-V power supply. For details, refer to *Σ -V Series User's Manual Design and Maintenance Rotational Motor/Command Option Attachable Type (SIEP S800000 60)*.

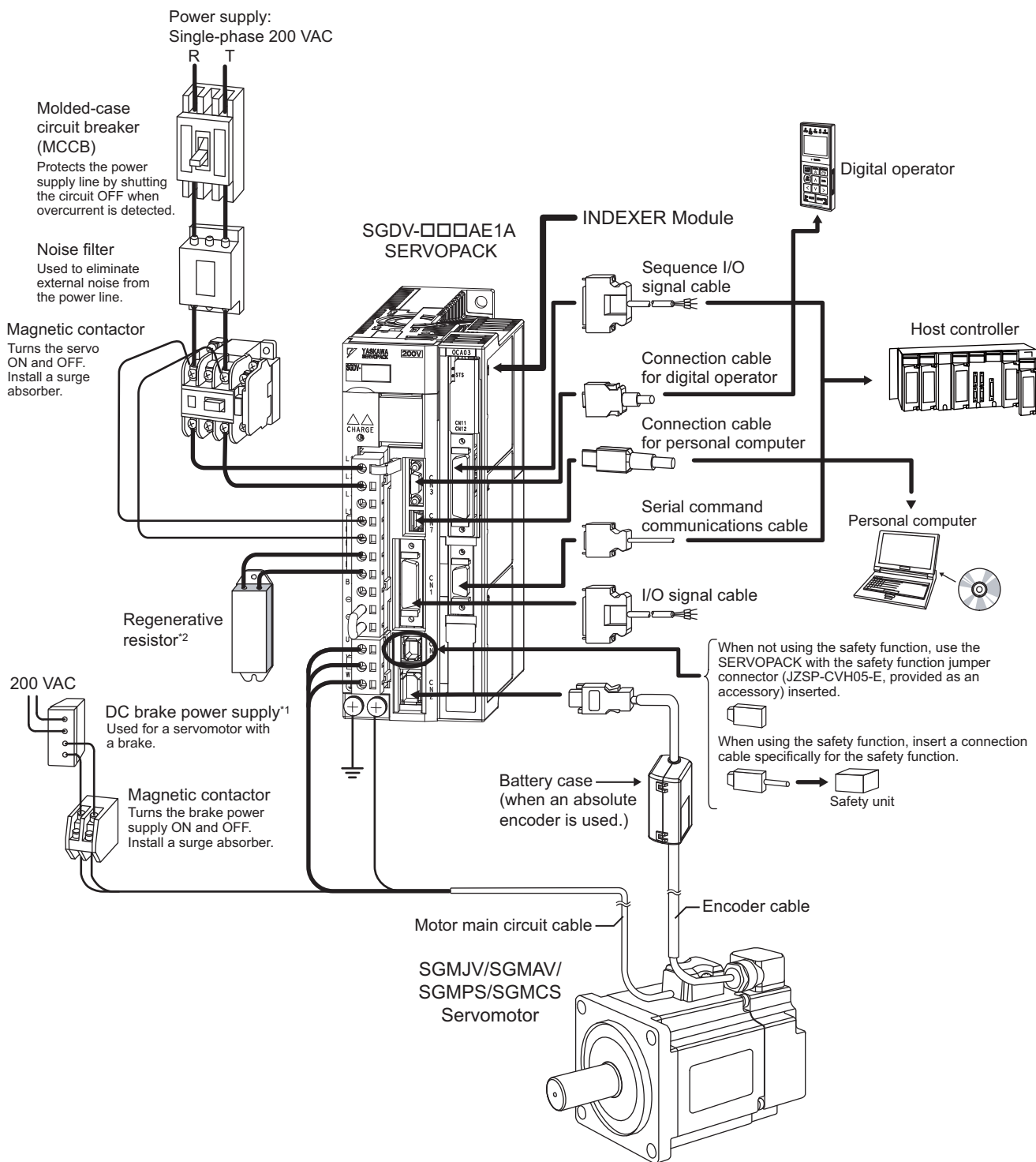

*1. Use a 24-VDC power supply. (not included.)

*2. Before connecting an external regenerative resistor to the SERVOPACK, refer to *Σ -V Series User's Manual Design and Maintenance Rotational Motor/Command Option Attachable Type (SIEP S800000 60)*.

Note: The connections and wiring of the power supply of the main circuit and that of the controls differ in accordance with the SERVOPACK to be used. For details, refer to *Σ -V Series User's Manual Design and Maintenance Rotational Motor/Command Option Attachable Type (SIEP S800000 60)*.

4.1.3 Connecting to SGD□□□DE1A SERVOPACK

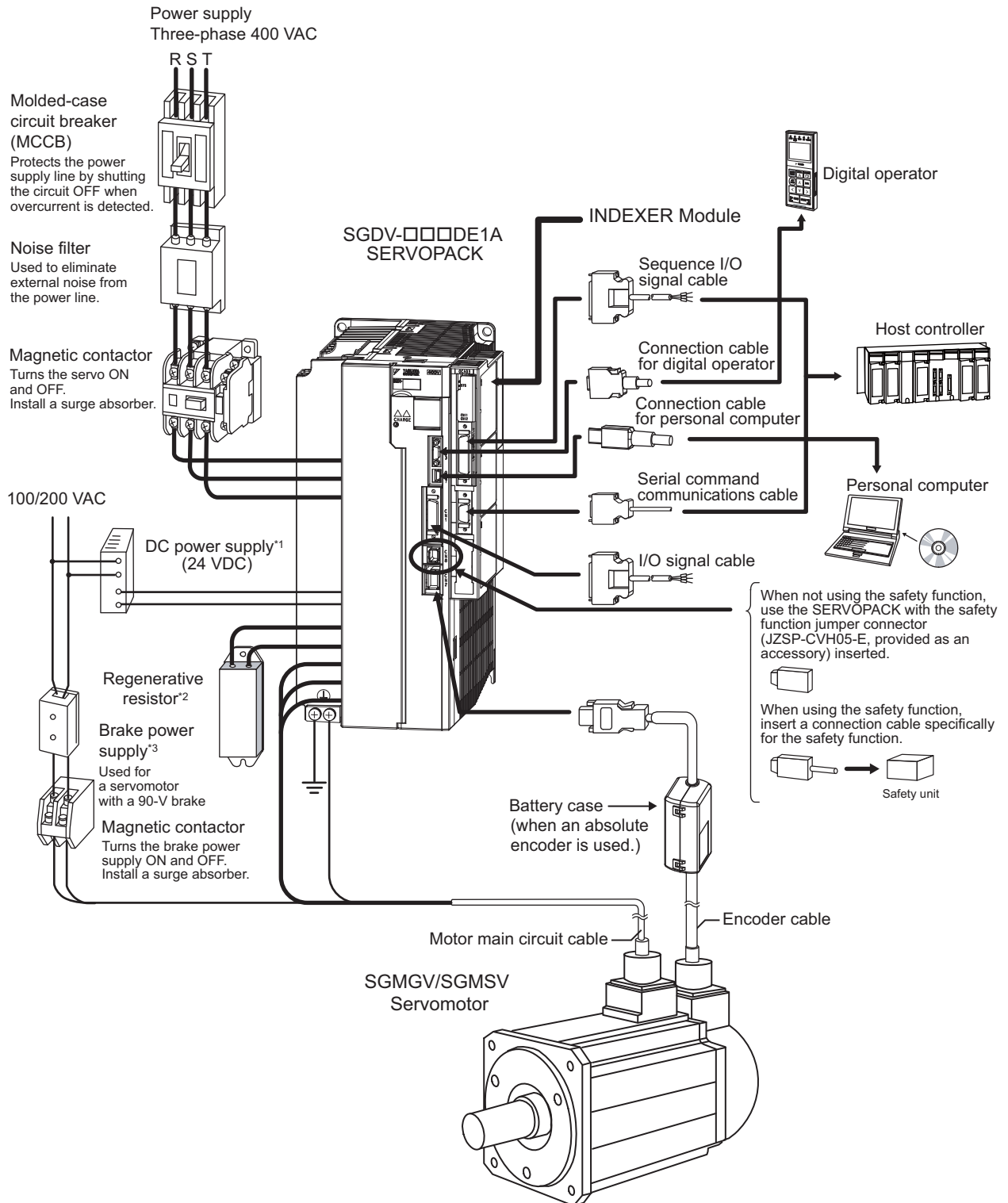

- *1. Use a 24-VDC power supply with double insulation or reinforced insulation. (The power supply is not included.)
- *2. Before connecting an external regenerative resistor to the SERVOPACK, refer to *Σ-V Series User's Manual Design and Maintenance Rotational Motor/Command Option Attachable Type* (SIEP S800000 60).
- *3. Use a following power supply for 90-V brake. For details, refer to *Σ-V Series Product Catalog* (KAEP S800000 42).
 - For 200-V input voltage: LPSE-2H01-E
 - For 100-V input voltage: LPDE-1H01-E

Note: The connections and wiring of the power supply of the main circuit and that of the controls differ in accordance with the SERVOPACK to be used. For details, refer to *Σ-V Series User's Manual Design and Maintenance Rotational Motor/Command Option Attachable Type* (SIEP S800000 60).

4.1.4 Connecting to SGDV-□□□FE5A SERVOPACK

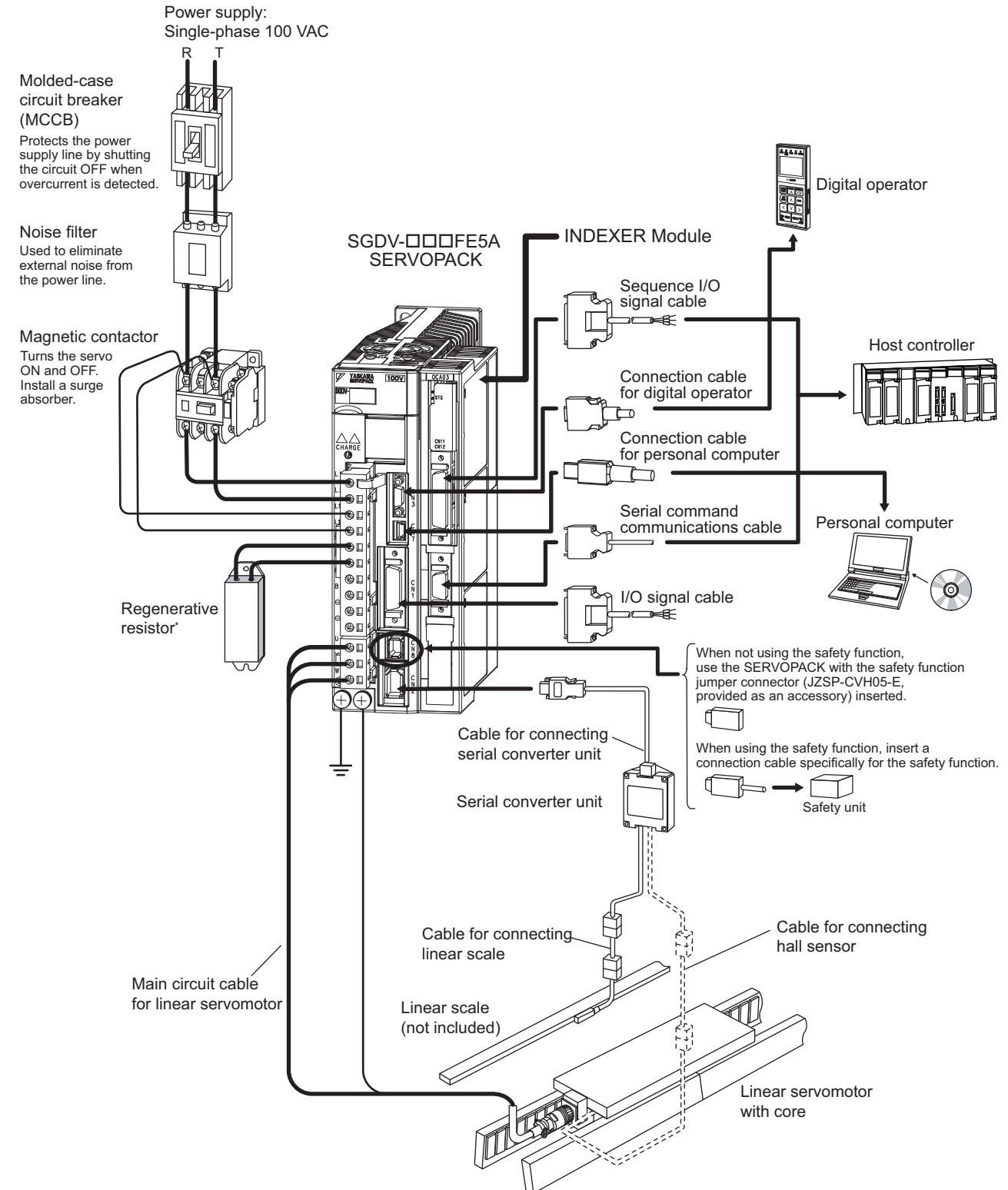

* Before connecting an external regenerative resistor to the SERVOPACK, refer to *ΣV Series User's Manual Design and Maintenance Linear Motor/Command Option Attachable Type* (SIEP S800000 66).

Note: The connections and wiring of the power supply of the main circuit and that of the controls differ in accordance with the SERVOPACK to be used. For details, refer to *ΣV Series User's Manual Design and Maintenance Linear Motor/Command Option Attachable Type* (SIEP S800000 66).

4.1.5 Connecting to SGDV-□□□AE5A SERVOPACK

(1) Using a Three-phase, 200 V Power Supply

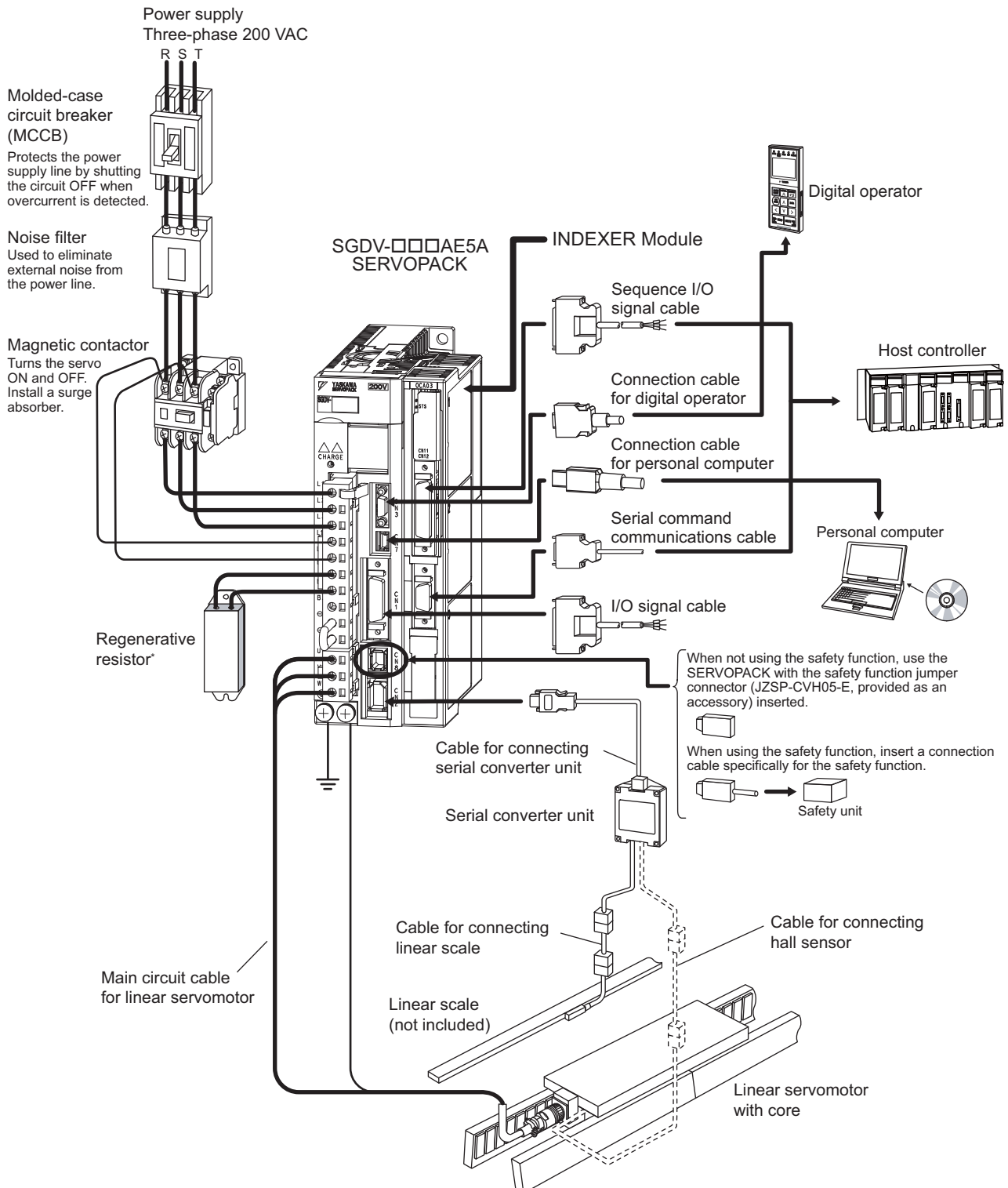

* Before connecting an external regenerative resistor to the SERVOPACK, refer to *Σ-V Series User's Manual Design and Maintenance Linear Motor/Command Option Attachable Type* (SIEP S800000 66).

Note: The connections and wiring of the power supply of the main circuit and that of the controls differ in accordance with the SERVOPACK to be used. For details, refer to *Σ-V Series User's Manual Design and Maintenance Linear Motor/Command Option Attachable Type* (SIEP S800000 66).

(2) Using a Single-phase, 200 V Power Supply

The Σ -V Series SERVOPACK for a 200-V power supply input has input specifications for a three-phase power supply, but some models can also be used with a single-phase 200-V power supply. For details, refer to *Σ -V Series User's Manual Design and Maintenance Linear Motor/Command Option Attachable Type* (SIEP S800000 66).

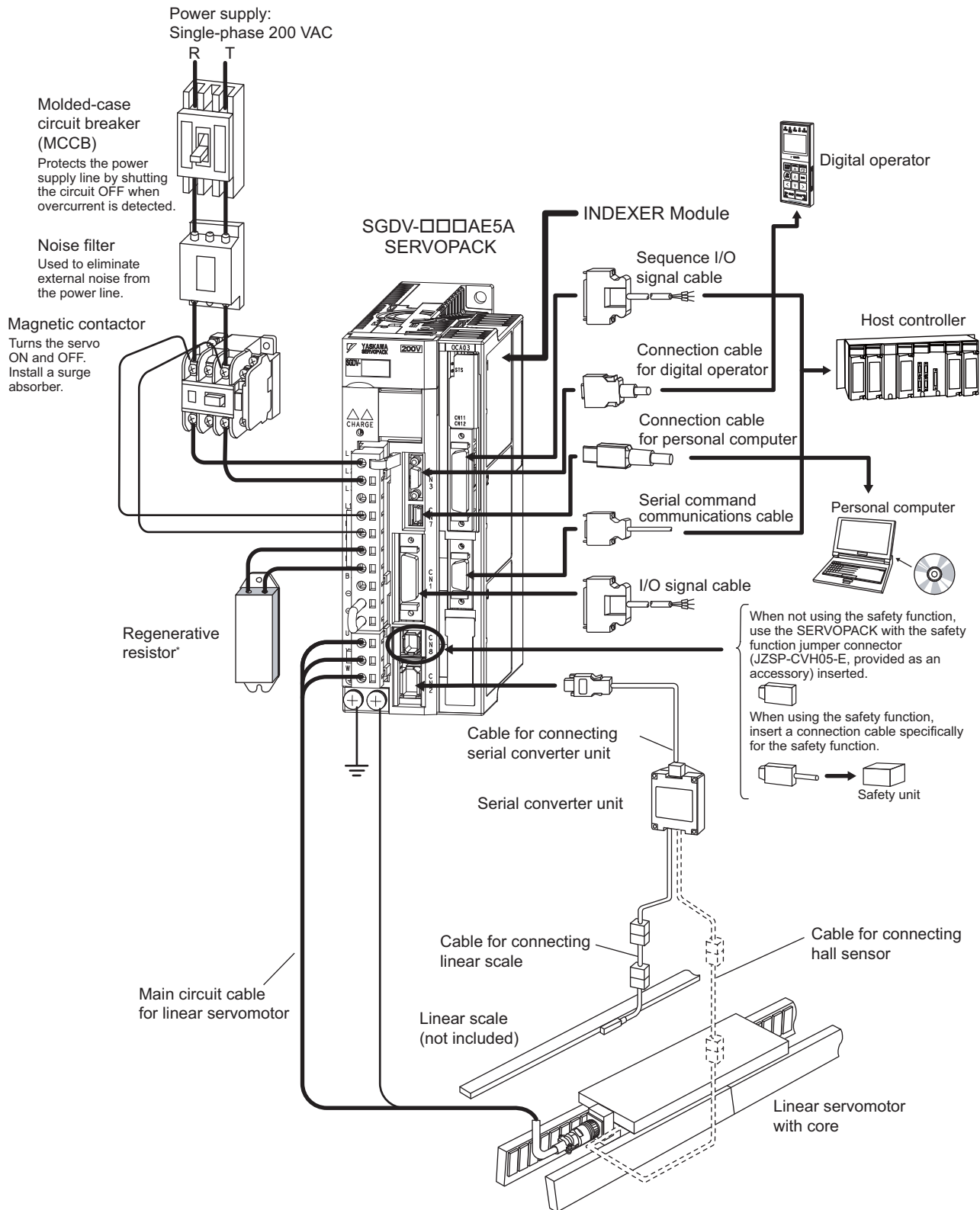

* Before connecting an external regenerative resistor to the SERVOPACK, refer to *Σ -V Series User's Manual Design and Maintenance Linear Motor/Command Option Attachable Type* (SIEP S800000 66).

Note: The connections and wiring of the power supply of the main circuit and that of the controls differ in accordance with the SERVOPACK to be used. For details, refer to *Σ -V Series User's Manual Design and Maintenance Linear Motor/Command Option Attachable Type* (SIEP S800000 66).

4.1.6 Connecting to SGDV-□□□DE5A SERVOPACK

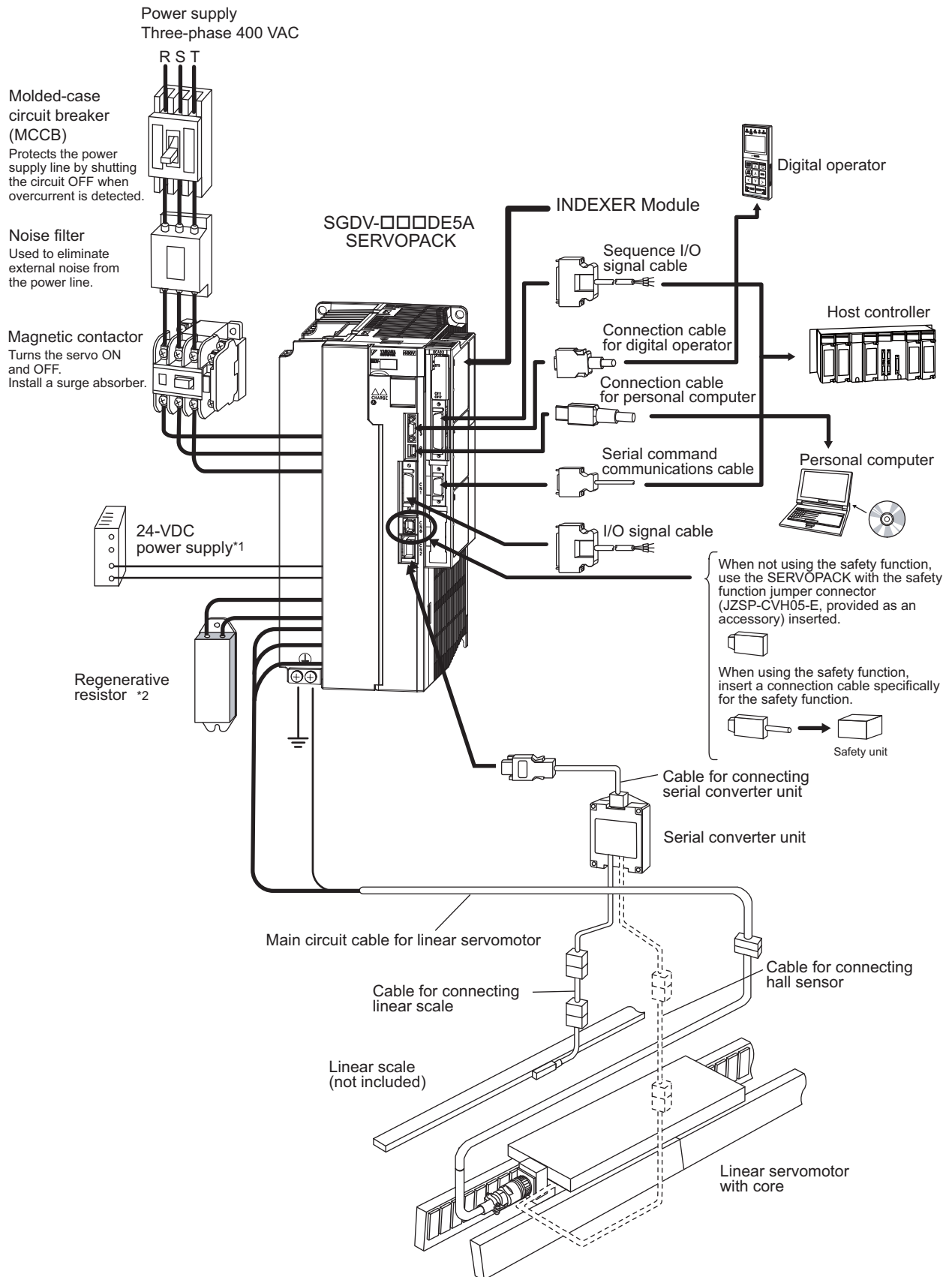

*1. Use a 24-VDC power supply with double insulation or reinforced insulation. (The power supply is not included.)
 *2. Before connecting an external regenerative resistor to the SERVOPACK, refer to *Σ-V Series User's Manual Design and Maintenance Linear Motor/Command Option Attachable Type* (SIEP S800000 66).
 Note: The connections and wiring of the power supply of the main circuit and that of the controls differ in accordance with the SERVOPACK to be used. For details, refer to *Σ-V Series User's Manual Design and Maintenance Linear Motor/Command Option Attachable Type* (SIEP S800000 66).

4.2 I/O Signal Connections

This section describes the names and functions of I/O signals. Also terminal layout and connection examples by control method are shown.

4.2.1 I/O Signal Names and Functions

The following table shows the names and functions of I/O signals.

 IMPORTANT	<p>Provide an external power supply; the SERVOPACK and INDEXER Module do not have an internal 24-V power supply.</p> <p>Yaskawa recommends using the same external power supply as that used for output circuits. Confirm the characteristics of relays and other mechanical contacts before using a power supply.</p>
---	--

(1) Input Signals

Signal Name	Pin No.	Name	Function
N-OT	9	Reverse Run Prohibited	Overtravel prohibited: Stops servomotor when movable part travels beyond the allowable range of motion.
/ALM-RST	7	Alarm Reset Input	–
P-OT	8	Forward Run Prohibited	Overtravel prohibited: Stops servomotor when movable part travels beyond the allowable range of motion.
/DEC	10	Homing Deceleration Limit Switch Input	Homing Deceleration Limit Switch: Connects to the deceleration limit switch for homing.
Not used	11	–	–
/RGRT	12	Registration	Registration Latch: This is a latch signal used for registration (external positioning).
+24VIN	6	Control Power Input for Sequence Signals	Used to input control power supply for sequence signals. Operable range: +11 V to +25 V Note: The +24-V power supply must be prepared by the customer.
BAT(+)	14	Battery (+) Input	Used to connect an absolute encoder's backup battery. Connect to CN8 or pins 14 and 15 of CN1.
BAT(-)	15	Battery (-) Input	
/S-ON	13	Servo ON Input	Servo ON: When ON, power is supplied to the motor. When OFF, power is not supplied to the motor.

Note: With the Reverse Run Prohibited and Forward Run Prohibited functions, the processing required to stop the SERVOPACK is executed by the software. In some cases, the safety specifications of an application may not fulfill the safety standards. Add external safety circuits as necessary.

(2) Output Signals

Signal Name	Pin No.	Name	Function
ALM+	3	Servo Alarm Output	Servo Alarm: Turns OFF when an error is detected.
ALM-	4		
/WARN+ (/SO1+)	1	Warning Signal Output	Error/Warning: ON for 2 seconds when an error has occurred. ON continuously while a warning is being detected.
/WARN- (/SO1-)	2		
/BK+ (/SO2+)	23	Brake Signal Output	Brake interlock (controls the brake): ON when the brake is released.
/BK- (/SO2-)	24		
/S-RDY+ (/SO3+)	25	Servo Ready Output	Servo Ready: ON when the control and main circuit power supplies are ON and a Servo Alarm has not occurred.
/S-RDY- (/SO3-)	26		
FG	Connector Shell	Frame Ground	By connecting the shielded wire of the I/O signal cable to the connector shell, it will be connected to the frame ground (earth).

Note: The allocation of /SO1, /SO2, and /SO3 can be changed to /ALO1, /ALO2, and /ALO3 by using PnB51. For details, refer to 5.3.3 *Servo Alarm Output Signal (ALM) and Alarm Code Output Signals (/ALO1, /ALO2, and /ALO3)*.

(3) CN11 Input Signals



IMPORTANT

Ensure that the following condition does not last longer than 5 minutes. Otherwise the product life may be shortened.

- The ambient temperature is high, and,
- There is a high ratio of CN11 input signal contacts that are ON (closed)^{*1} (contact ON ratio^{*2}).

The allowable ranges for ambient temperature and contact ON ratio are shown below.

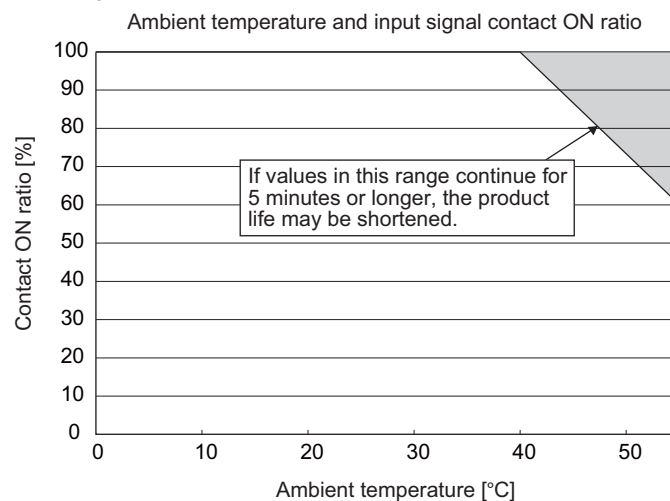

- *1. The state that a contact is ON (closed) indicates, regardless of the logic of the input signal, that the contact is closed and that current is flowing in the input circuit.
- *2. For example, a contact ON ratio of 100% indicates that 11 out of the 11 contacts are ON.

Signal Name	Pin No.	Function
+24V/COM	1	Power Supply for Sequence Signals. Voltage range: 24 VDC \pm 10%
/MODE 0/1	3	This pin switches between Mode 0 and Mode 1. ON: Mode 0 (program table operation) OFF: Mode 1 (JOG speed table operation or homing)
/START-STOP; /HOME	5	Mode 0: When ON, starts or restarts program table operation. Refers to signals /SEL0 through /SEL7 when starting operation. When OFF, interrupts program table operation. Mode 1: When ON, starts or restarts homing. When OFF, interrupts homing.
/PGMRES; /JOGP	7	Mode 0: When ON while program table operation is interrupted, resets program table operation. Mode 1: When ON, causes forward JOG operation. When OFF, stops forward JOG operation.
/SEL0; /JOGN	9	Mode 0: Program table 0 Mode 1: When ON, causes reverse JOG operation. When OFF, stops reverse JOG operation.
/SEL1; /JOG0	11	Mode 0: Program table selection 1 Mode 1: JOG speed table selection 0
/SEL2; /JOG1	13	Mode 0: Program table selection 2 Mode 1: JOG speed table selection 1
/SEL3; /JOG2	15	Mode 0: Program table selection 3 Mode 1: JOG speed table selection 2
/SEL4; /JOG3	17	Mode 0: Program table selection 4 Mode 1: JOG speed table selection 3
/SEL5	14	Mode 0: Program table selection 5 Mode 1: –
/SEL6	16	Mode 0: Program table selection 6 Mode 1: –
/SEL7	18	Mode 0: Program table selection 7 Mode 1: –

(4) CN11 Output Signals

Signal Name	Pin No.	Function
/INPOSITION+	19	Positioning complete
/INPOSITION-	20	
/POUT0+	21	Programmable outputs
/POUT0-	22	
/POUT1+	23	
/POUT1-	24	
/POUT2+	25	
/POUT2-	26	
/POUT3+	27	
/POUT3-	28	
/POUT4+	29	
/POUT4-	30	
/POUT5+	31	
/POUT5-	32	
/POUT6+	33	
/POUT6-	34	
/POUT7+	35	
/POUT7-	36	

4.2.2 Interface Circuits

This section shows examples of SERVOPACK I/O signal connection to the host controller.

(1) Interfaces with Sequence Input Circuits

The sequence input circuit interface connects through a relay or open-collector transistor circuit. Select a low-current relay otherwise a faulty contact will result.

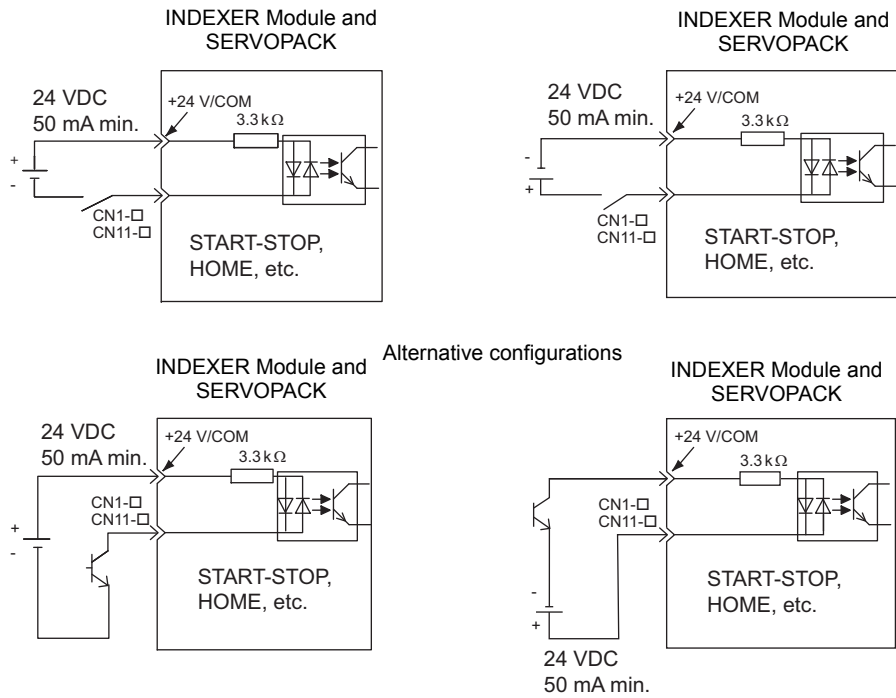

(2) Interfaces with Output Circuits

The SERVOPACK signals use the following types of output circuits. Construct an input circuit on the host controller side to match the output circuit.

- Connecting to a Photocoupler Output Circuit

Connect a photocoupler output circuit through a relay or line receiver circuit.

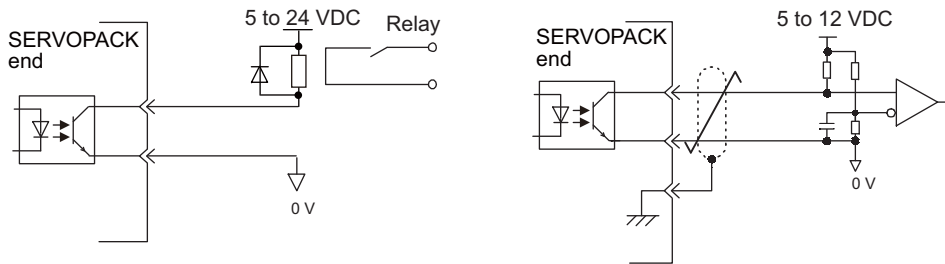

Note: The maximum allowable voltage and current capacities for photocoupler output circuits are as follows:

- Voltage: 30 VDC max.
- Current: 50 mA DC max.

4.2.3 Example of I/O Signal Connections

The following diagram shows a typical connection example.

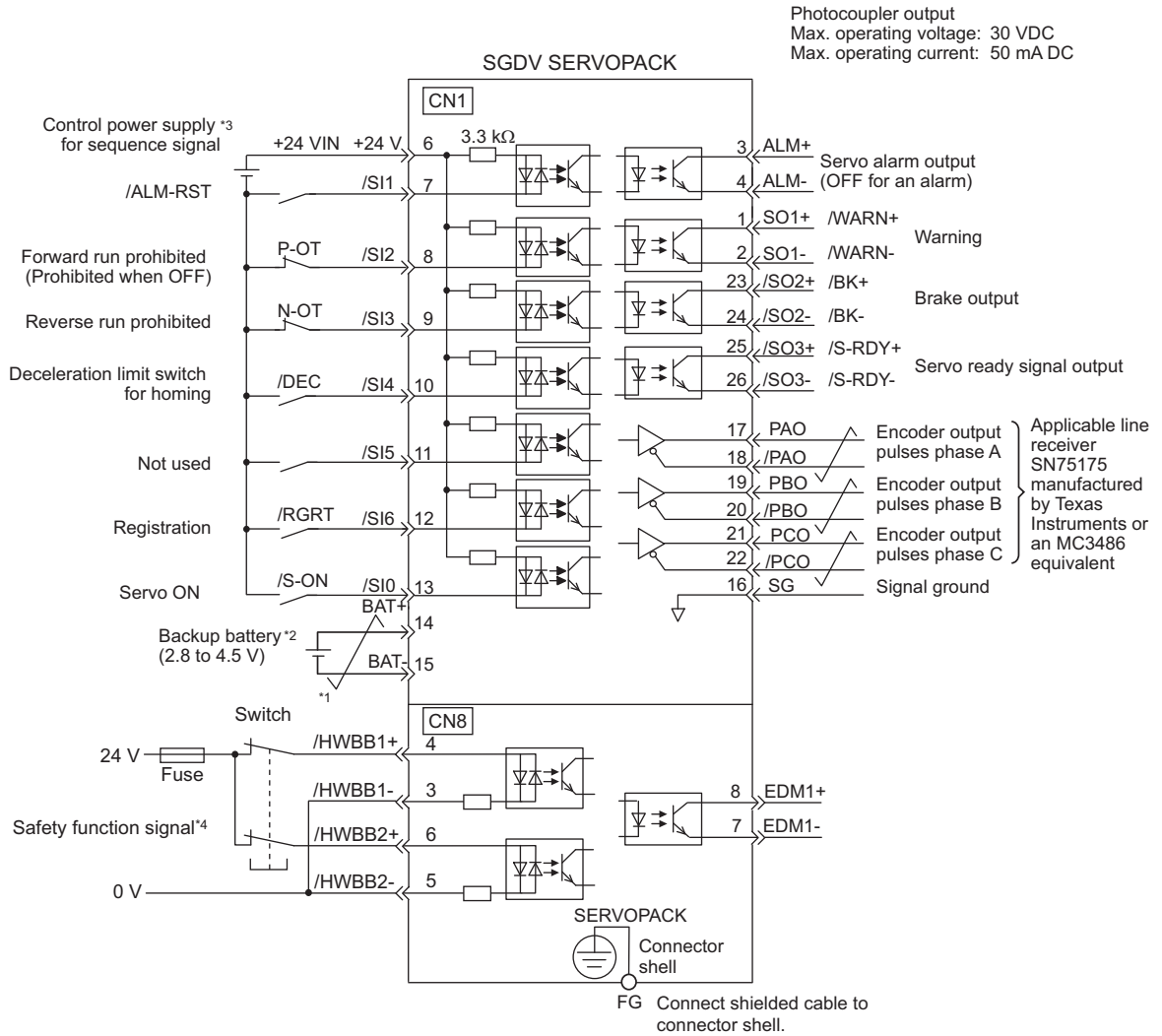

- *1. represents twisted-pair wires.
- *2. Connect when using an absolute encoder. When the encoder cable for the battery case is connected, do not connect a backup battery.
- *3. The 24-VDC power supply is not included. Use a power supply with double insulation or reinforced insulation.
- *4. To turn the servomotor power ON, a safety unit must be connected and the wiring to activate the safety function must be done. When not using the safety function, use the SERVOPACK with the safety jumper connector (JZSP-CVH05-E, provided as an accessory) inserted into the CN8.

Example Connections to I/O Signal Connector CN1

4.2.3 Example of I/O Signal Connections

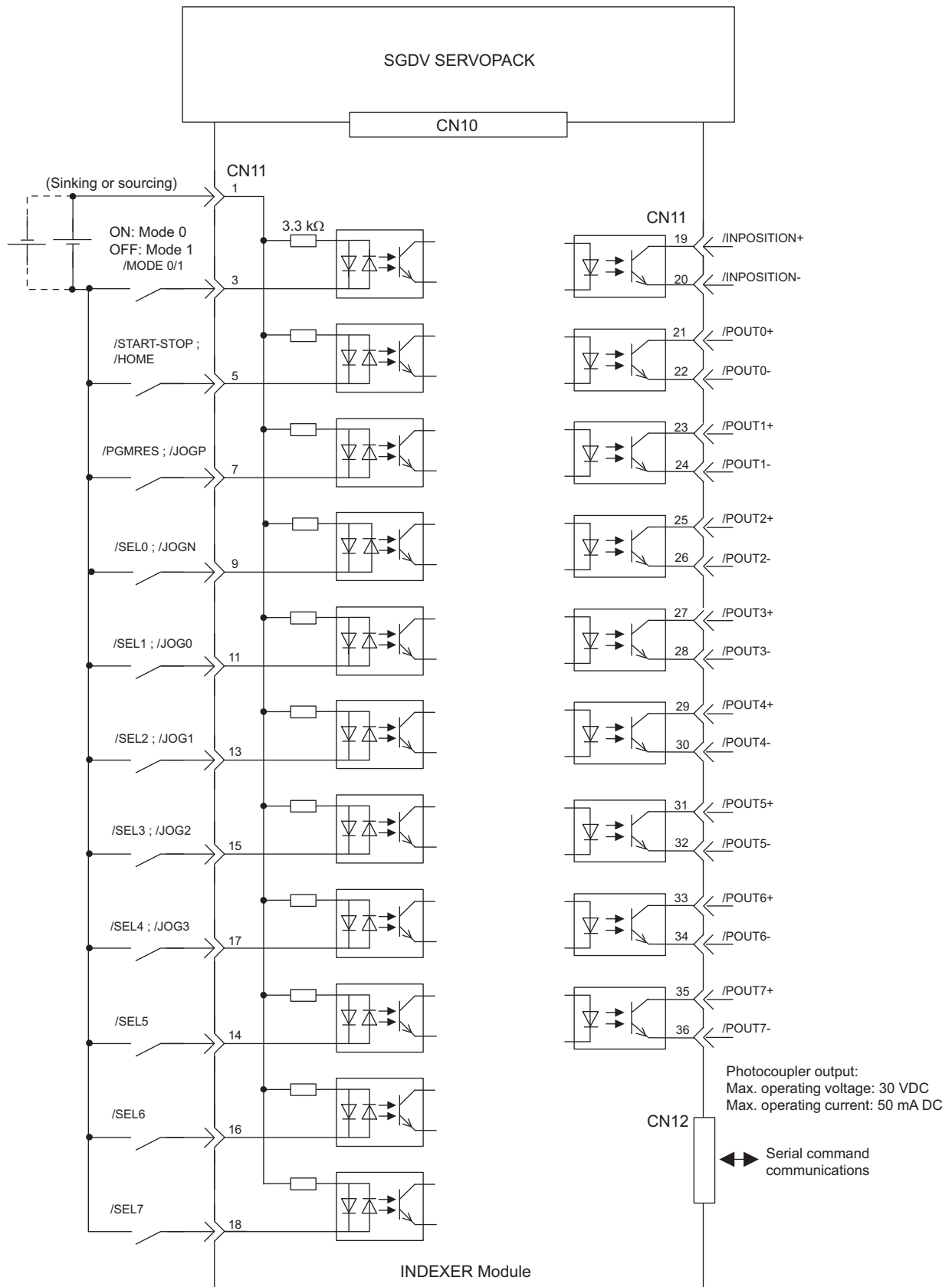

Note: /START-STOP, /PGMRES, /SEL0, /SEL1, /SEL2, /SEL3, /SEL4, /SEL5, /SEL6, and /SEL7 signals are valid when Mode 0 is set. /HOME, /JOGP, /JOGN, /JOG0, /JOG1, /JOG2, and /JOG3 signals are valid when Mode 1 is set.

Example Connections to I/O Signal Connector CN11

4.3 Serial Command Communications Connector (CN12)

Serial commands can be used to perform operations such as positioning, setting parameters and program tables, monitoring, and other operations.

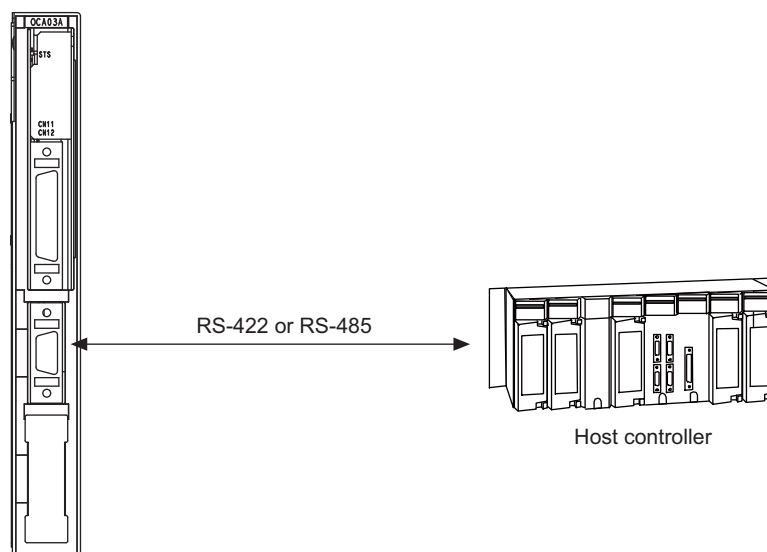

4.3.1 Communications Specifications

The following table shows the communications specifications of the CN12 connector.

Item	Specifications
Interface	Full duplex (RS-422) or half duplex (RS-485) (Selectable with parameter PnB00.)
Max. Number of Axes	16 axes
Total Cable Length	RS-422/RS-485: 50 m max.
Bit Rate	9600, 19200, or 38400 bps (Selectable with parameter PnB01. Factory setting: 9600 bps)
Synchronization	Start-stop synchronization
Data Format	Start bits: 1 bit Data bits: 7 bits, ASCII Parity: 1 bit, even parity Stop bits: 1 bit
Flow Control	None
Shift Control	None

4.3.2 Communications Connector

(1) Connector Model

INDEXER Module-end Connector	Applicable Receptacles		
	Solder Type	Case	Manufacturer
10214-52A2PL 14P	10114-3000PE	10314-52A0-008	Sumitomo 3M Limited

4.3.3 Connector Signal Names

Pin No.	Signal Name	Signal Circuit Name	Signal Direction
1	TXD	Transmit data (not inverted)	Host controller ← INDEXER Module
2	/TXD	Transmit data (inverted)	Host controller ← INDEXER Module
3	RXD	Receive data (not inverted)	Host controller → INDEXER Module
4	/RXD	Receive data (inverted)	Host controller → INDEXER Module
5	GND	Signal ground (0 V)	–
6	/RXD	Receive data (inverted)	–
7	RT	If RT and /RXD are connected (shorted), the built-in terminator (120 Ω) will be connected between RXD and /RXD.	
8	TXD	Transmit data (not inverted)	Host controller ← INDEXER Module
9	/TXD	Transmit data (inverted)	Host controller ← INDEXER Module
10	RXD	Receive data (not inverted)	Host controller → INDEXER Module
11	Reserved	Reserved pin	–
12	Reserved	Reserved pin	–
13	Reserved	Reserved pin	–
14	GND	Signal ground (0 V)	–

4.3.4 Connection Examples

(1) Full-duplex Wiring

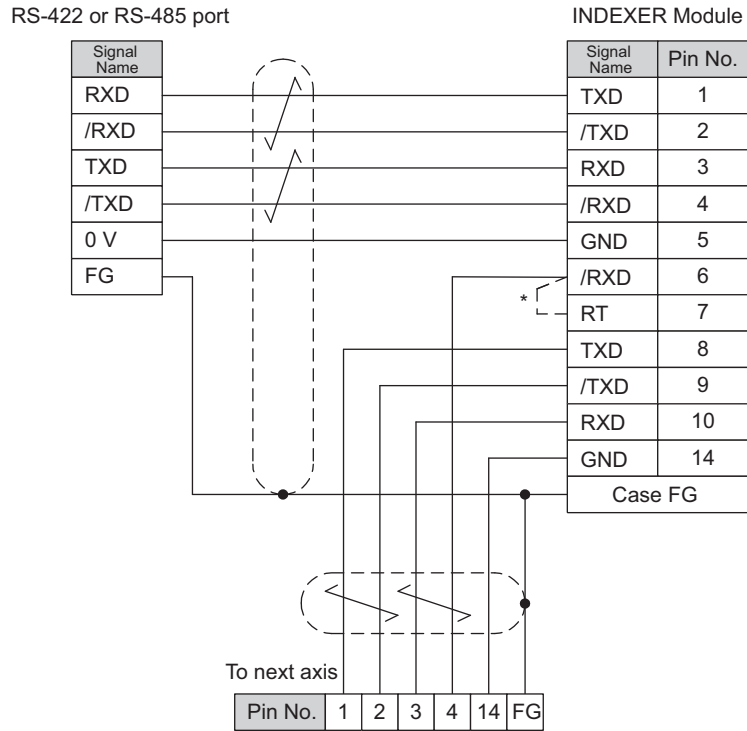

Full-duplex Wiring

* Connect (short) the RT and /RXD pins in the last axis.
 Note: Cable length: 50 m max.

(2) Half-duplex Wiring

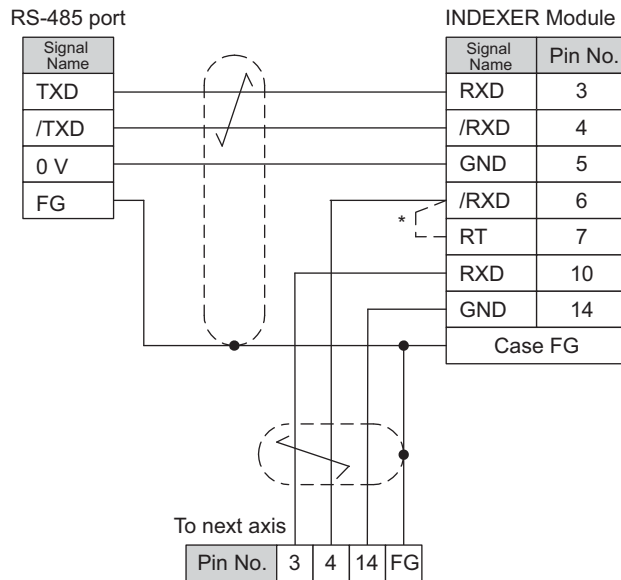

Half-duplex Wiring

* Connect (short) the RT and /RXD pins in the last axis.

4.3.5 RS-422/RS-485 Interface

The maximum total length for RS-422 or RS-485 cable is 50 m. Use the minimum length of cable that is needed.

The INDEXER Module's communications circuits are not insulated. If communications errors occur because of noise, use noise suppression methods such as shielded cable or ferrite cores.

When using full-duplex wiring, connect a terminator in the host controller's reception circuit and the reception circuit of the last INDEXER Module in the line. The INDEXER Module has a built-in terminator ($120\ \Omega$) that is connected between the RXD and /RXD pins when the RT and /RXD pins are shorted.

When using half-duplex wiring, connect a terminator at both ends of the communications cable. The INDEXER Module has a built-in terminator ($120\ \Omega$) that is connected between the RXD and /RXD pins when the RT and /RXD pins are shorted.

The INDEXER Module's transmission circuit is high-impedance when it is not transmitting. Pull-up or pull-down the host controller's reception circuit.

4.4 Power Loss in the INDEXER Module

Power loss in the INDEXER Module is shown below.

The INDEXER Module's power is supplied from the SERVOPACK.

INDEXER Module Specifications

Item	Specifications
Min. operating voltage	5.05 V
Max. operating voltage	5.25 V
Max. operating current	500 mA
Max. power loss	2.6 W

For the SERVOPACK power losses at the rated output, refer to the following manuals.

- 3.1 Main Circuit Wiring in the Σ -V Series User's Manual Design and Maintenance Rotational Motor/Command Option Attachable Type (SIEP S800000 60)
- 3.1 Main Circuit Wiring in the Σ -V Series User's Manual Design and Maintenance Linear Motor/Command Option Attachable Type (SIEP S800000 66)

Parameter Setting and Functions

This chapter describes the use of the I/O signals in the SGD V SERVOPACK and INDEXER Module (I/O signals in the CN1 and CN11 connectors) as well as the procedure for setting the related parameters for the intended purposes.

The following sections can be used as references for this chapter.

- Lists of CN1 and CN11 I/O signals: Refer to *4.2.1 I/O Signal Names and Functions*.
- List of parameters: Refer to *10.1 Parameter List for INDEXER Module*.

5.1	Parameter Configurations	5-2
5.2	Restrictions on SGD V SERVOPACK Parameters	5-3
5.3	Sequence I/O Signals	5-5
5.3.1	Servo ON Signal (/S-ON)	5-5
5.3.2	Overtravel	5-5
5.3.3	Servo Alarm Output Signal (ALM) and Alarm Code Output Signals (/ALO1, /ALO2, and /ALO3)	5-7
5.3.4	Braking Signal (/BK)	5-8
5.3.5	Servo Ready Output Signal (/S-RDY)	5-9
5.3.6	Error/Warning Output Signal (/WARN)	5-9
5.3.7	Positioning Completed Output Signal (/INPOSITION)	5-10
5.3.8	Programmable Output Signals (/POUT0 to /POUT7)	5-11
5.3.9	Encoder Signal Outputs	5-12
5.4	Settings According to Device Characteristics	5-13
5.4.1	Setting Reference Units	5-13
5.4.2	Moving Mode and Coordinate Settings	5-16
5.4.3	Setting Home Position	5-18
5.4.4	Backlash Compensation	5-19
5.4.5	Torque Limit	5-19
5.4.6	Fully-closed Loop Control	5-20

5.1 Parameter Configurations

Parameters are comprised of the types shown in the following table. Refer to *Chapter 10*.

Type	Parameter No.	Description
Function Selection Parameters	Pn000 to Pn010 PnB1F	Select basic and application functions such as the type of control mode or the stop method when an alarm occurs.
Servo Gain and Other Parameters	Pn100 to Pn170	Set numerical values such as speed and position loop gains.
Position Control Parameters	Pn205 to Pn217	Set position control parameters such as average movement time.
Speed Control Parameters	Pn304 to Pn324	Set speed control parameters such as the speed feedback filter.
Torque Control Parameters	Pn401 to Pn460	Set torque control parameters such as the torque limit values.
Sequence Parameters	Pn506 to Pn561 PnB03 to PnB1E PnB4F PnB51 to PnB52	Set conditions for the sequence I/O signals.
Positioning Parameters	PnB20 to PnB2F PnB50	Set parameters related to positioning.
Homing Parameters	PnB31 to PnB39	Set parameters related to homing.
Others	Pn600 to Pn601	Set other parameters.
Serial Communications Parameters	PnB00 to PnB02	Set parameters related to serial communications through CN6.
Setup Information Parameters	PnB3B to PnB4D	Do not change these parameters. These are reserved parameters.
Fully-closed Loop Control Parameters	Pn20A, Pn22A, Pn281 Pn51B, Pn52A	Set parameters related to fully-closed loop control.
Linear Servomotor Parameters	Pn080 Pn181 to Pn182 Pn281 to Pn282 Pn380 to Pn385 Pn480 to Pn498 Pn581 to Pn587	Set parameters related to linear servomotors.

5.2 Restrictions on SGDV SERVOPACK Parameters

The following parameters are set automatically when an INDEXER Module is installed on an SGDV SERVOPACK. Do not change these parameters because they are reserved for system use. Also, the SGDV SERVOPACK will be set for position control. It is not necessary to set parameters related to speed control or torque control, so those parameters should not be changed.

After the INDEXER Module is installed, it will take up to 10 seconds before the SERVOPACK starts up for the first time because the parameters are set automatically the first time that the power is turned ON.

Parameter No.	Digit	Description	Setting	Description
Pn002	0	Torque Limit Reference Selection for Command Option Module	0	Torque limit references from command option modules are not used.
Pn205	–	Multi-turn Limit	0	When the encoder being used is a single-turn absolute encoder and also Pn002.2 = 0, zero is automatically set.
Pn207	3	COIN Output Timing	1	–
Pn50A	0	Reserved (Do not change.)	1	–
	1	Reserved (Do not change.)	8	–
	2	Reserved (Do not change.)	8	–
	3	P-OT Signal Mapping	8	Not used*
Pn50B	0	N-OT Signal Mapping	8	Not used*
	1	Reserved (Do not change.)	8	–
	2	/P-CL Signal Mapping	8	Not used
	3	/N-CL Signal Mapping	8	Not used
Pn50E	0	Positioning Completion Signal Mapping (/COIN)	0	Not used
	1	Speed Coincidence Detection Signal Mapping (/V-CMP)	0	Not used
	2	Servomotor Rotation Detection Signal Mapping (/TGON)	0	Not used
	3	Servo Ready Signal Mapping (/S-RDY)	0 or 3	The INDEXER Module sets a value matched to PnB51.
Pn50F	0	Torque Limit Detection Signal Mapping (/CLT)	0	Not used
	1	Speed Limit Detection Signal Mapping (/VLT)	0	Not used
	2	Brake Signal Mapping (/BK)	0 or 2	The INDEXER Module sets a value matched to PnB51.
	3	Warning Signal Mapping (/WARN)	0 or 1	The INDEXER Module sets a value matched to PnB51.
Pn510	0	Near Signal Mapping (/NEAR)	0	Not used
	1	Reserved (Do not change.)	0	–
	2	Reserved (Do not change.)	0	–
	3	Reserved (Do not change.)	0	–
Pn511	0	Input Signal 3 Mapping for Command Option Module (/S13)	8	Not used
	1	Input Signal 4 Mapping for Command Option Module (/S14)	6 or 8 or F	The INDEXER Module sets a value matched to PnB12.*
	2	Input Signal 5 Mapping for Command Option Module (/S15)	4 or 8 or D	The INDEXER Module sets a value matched to PnB11.*
	3	Input Signal 6 Mapping for Command Option Module (/S16)	8	Not used

(cont'd)

Parameter No.	Digit	Description	Setting	Description
Pn512	0	Output Signal Inversion for CN1-1 or -2 Terminals	0 or 1	The INDEXER Module sets a value matched to PnB1C and PnB51.
	1	Output Signal Inversion for CN1-23 or -24 Terminals	0 or 1	The INDEXER Module sets a value matched to PnB1D and PnB51.
	2	Output Signal Inversion for CN1-25 or -26 Terminals	0 or 1	The INDEXER Module sets a value matched to PnB1E and PnB51.
	3	Reserved (Do not change.)	0	–
Pn517	0	ALO1 Output Signal Mapping	0 or 1	The INDEXER Module sets a value matched to PnB51.
	1	ALO2 Output Signal Mapping	0 or 2	
	2	ALO3 Output Signal Mapping	0 or 3	
	3	Reserved (Do not change.)	0	
Pn522	–	Positioning Completed Width	0 to 99999	The INDEXER Module sets a value matched to PnB2D.

* /S-ON, P-OT, N-OT, /ALM-RST, /DEC, /RGRT are allocated to each terminal in a fixed manner.
For the connector terminal layout, refer to Chapter 3.

5.3 Sequence I/O Signals

This section explains sequence I/O signals.

In this section, the word “open” or “close” shown in parentheses in parameter descriptions indicates that the contact is open or closed.

5.3.1 Servo ON Signal (/S-ON)

This sets the servo ON signal (/S-ON) that determines whether the servomotor power is ON or OFF.

Type	Name	Connector Pin No.	Setting	Meaning
Input	/S-ON	CN1-13	ON	Servomotor power is ON. Servomotor can be operated.
			OFF	Servomotor power is OFF. Servomotor cannot be operated.

The setting of the /S-ON signal can be changed with the parameter below.

Parameter	Meaning	When Enabled	
PnB0E	0 [Factory setting]	When input signal is ON (close), servomotor power is ON. Servomotor can be operated.	After restart
	1	When input signal is OFF (open), servomotor power is ON. Servomotor can be operated.	
	2	Servomotor power is always ON.	
	3	Servomotor power is always OFF.	

5.3.2 Overtravel

The overtravel limit function forces movable machine parts to stop by turning ON a limit switch if they exceed the allowable range of motion.

For rotating applications such as rotary tables and conveyors, an overtravel function is not always necessary, and in this case no wiring for overtravel input signals is required.

(1) Signal Specifications

Type	Name	Connector Pin No.	Setting	Meaning
Input	P-OT	CN1-8	ON (close)	Forward run allowed. Normal operation status.
			OFF (open)	Forward run prohibited. Forward overtravel.
	N-OT	CN1-9	ON (close)	Reverse run allowed. Normal operation status.
			OFF (open)	Reverse run prohibited. Reverse overtravel.

Rotation in the opposite direction is possible during overtravel by inputting the reference.

(2) Changing Input Signal Settings

The settings of the input signals for overtravel can be changed with the parameters below.

Parameter		Meaning	When Enabled
PnB0F	0 [Factory setting]	When input signal is OFF (open), forward run is prohibited (forward overtravel).	After restart
	1	When input signal is ON (close), forward run is prohibited (forward overtravel).	
	2	Forward run is always prohibited (forward overtravel).	
	3	Forward run is always enabled. (P-OT signal is not used.)	
PnB10	0 [Factory setting]	When input signal is OFF (open), reverse run is prohibited (reverse overtravel).	
	1	When input signal is ON (close), reverse run is prohibited (reverse overtravel).	
	2	Reverse run is always prohibited (reverse overtravel).	
	3	Reverse run is always enabled. (N-OT signal is not used.)	

Note: During the overtravel state or software limit state, the servomotor is not positioned to the target position specified by the controller. Check the current position to confirm that the axis is stopped at a safe position.

(3) Motor Stopping Method When Overtravel is Used

Set the following parameter to specify the motor stopping method when overtravel is used.

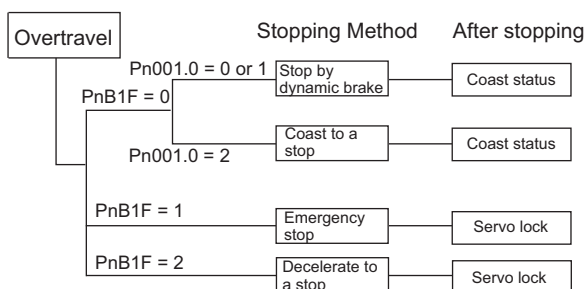

Parameter		Meaning	When Enabled
PnB1F	0 [Factory setting]	Stops motor by the same method as when servo is turned OFF according to Pn001.0 setting.	After restart
	1	Stops motor immediately, and then changes motor state to servo lock.	
	2	Decelerates motor to a stop at deceleration rate set with PnB2B, and then changes motor state to servo lock.	

Set the deceleration rate when decelerating to a stop in PnB2B.

PnB2B	Deceleration			
	Setting Range	Setting Unit	Factory Setting	When Enabled
	1 to 99999999	1000 (Reference units/min) /ms	1000	Immediately



IMPORTANT

If the servo turns OFF due to overtravel, the servo will not turn ON even if the overtravel is released. To turn ON the servo, turn the /S-ON signal OFF and then ON or send the SVON serial command. If parameter PnB0E is set to 2 to keep the /S-ON signal always ON, turn the power supply OFF and then ON again.

5.3.3 Servo Alarm Output Signal (ALM) and Alarm Code Output Signals (/ALO1, /ALO2, and /ALO3)

This section describes signals that are output when the SERVOPACK detects errors and resetting methods.

(1) Servo Alarm Output Signal (ALM)

This signal is output when the SERVOPACK detects an error.

 IMPORTANT	<p>Configure an external circuit so that this alarm output turns OFF the main circuit power supply for the SERVOPACK whenever an error occurs.</p>
---	--

Type	Signal Name	Connector Pin No.	Setting	Meaning
Output	ALM	CN1-3, 4	ON (close)	Normal SERVOPACK status
			OFF (open)	SERVOPACK alarm status

(2) Alarm Code Output Signals (/ALO1, /ALO2, and /ALO3)

The ON/OFF combination of these signals specifies the type of alarm detected by the SERVOPACK.

Use these signals as required to display the contents of the alarm at the host controller.

For details, refer to 9.1.1 *List of Alarms for Command Option Attachable Type SERVOPACKs*.

Type	Signal Name	Connector Pin No.	Description
Output	/ALO1	CN1-1, 2	Alarm code output
	/ALO2	CN1-23, 24	Alarm code output
	/ALO3	CN1-25, 26	Alarm code output

Select whether /ALO1 to /ALO3 are used or /WARN, /BK and /S-RDY are used with the parameter below.

Parameter	Meaning	When Enabled	
PnB51	0 [Factory setting]	Does not output /ALO1 to /ALO3. (/WARN, /BK, and /S-RDY are output.)	After restart
	1	Outputs /ALO1 to /ALO3. (/WARN, /BK, and /S-RDY are not output.)	

(3) Alarm Reset Method

If a servo alarm (ALM) occurs, first eliminate the cause of that alarm, then reset the alarm.

It is sometimes not possible to reset encoder-related alarms with the /ALM-RST signal. In such cases, shut off the control power and then reset the alarm.

 IMPORTANT	<p>Be sure to eliminate the cause of an alarm before resetting the alarm. Resetting an alarm without eliminating its cause and then continuing operation may result in damage to the product or fire.</p>
---	---

Type	Signal Name	Connector Pin No.	Description
Input	/ALM-RST	CN1-7	Alarm reset

5.3.4 Braking Signal (/BK)

The setting of the /ALM-RST signal can be changed with the parameter below.

Parameter	Meaning	When Enabled	
PnB52	0 [Factory setting]	Resets alarms by switching input signal from OFF (open) to ON (close).	After restart
	1	Resets alarms by switching input signal from ON (close) to OFF (open).	
	2	Does not reset alarms. (Signal is ignored.)	
	3		

5.3.4 Braking Signal (/BK)



IMPORTANT

- Inverting the polarity of the brake output signal (/BK), i.e. positive logic, will prevent the holding brake from working in case of its signal line disconnection. If this setting is absolutely necessary, check the operation and confirm that there are no safety problems.
- Configure the relay circuit to apply the holding brake by the emergency stop.

Relay Circuit Example

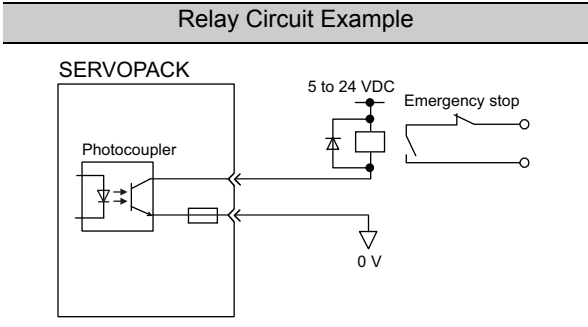

- Failures caused by incorrect wiring or wrong voltage application in the brake circuit may damage the equipment or cause an accident resulting in death or injury. Follow the procedures and instructions for wiring and trial operation precisely as described in the manual.

This output signal controls the brake.

The /BK signal turns OFF when an alarm is detected or the servomotor power is OFF. The brake OFF timing can be adjusted with Pn506.

Type	Name	Connector Pin No.	Setting	Meaning
Output	/BK	CN1-23, CN1-24	ON (close)	Releases the brake.
			OFF (open)	Applies the brake.

The setting of the /BK signal can be changed with the parameters below.

Parameter	Meaning	When Enabled	
PnB1D	0 [Factory setting]	When the /BK signal is ON (close), the brake is released.	After restart
	1	When the /BK signal is OFF (open), the brake is released.	
PnB51	0 [Factory setting]	Does not output /ALO1 to /ALO3. (/WARN, /BK, and /S-RDY are output.)	After restart
	1	Outputs /ALO1 to /ALO3. (/WARN, /BK, and /S-RDY are not output.)	

5.3.5 Servo Ready Output Signal (/S-RDY)

This signal is turned ON when the SERVOPACK is ready to accept the servo ON (/S-ON) signal.

The /S-RDY signal is turned ON under the following conditions.

- The main circuit power supply is ON.
- No hard wire base block state
- No servo alarms

Type	Signal Name	Connector Pin No.	Setting	Meaning
Output	/S-RDY	CN1-25, 26	ON (close)	SERVOPACK is ready to accept the servo ON signal (/S-ON).
			OFF (open)	SERVOPACK is not ready to accept the servo ON signal (/S-ON).

The setting of the /S-RDY signal can be changed with the parameters below.

Parameter		Meaning	When Enabled
PnB1E	0 [Factory setting]	When SERVOPACK is ready, photocoupler becomes ON (close).	After restart
	1	When SERVOPACK is ready, photocoupler becomes OFF (open).	
PnB51	0 [Factory setting]	Does not output /ALO1 to /ALO3. (/WARN, /BK, and /S-RDY are output.)	After restart
	1	Outputs /ALO1 to /ALO3. (/WARN, /BK, and /S-RDY are not output.)	

5.3.6 Error/Warning Output Signal (/WARN)

This is the error or warning signal before an alarm occurs. An error signal is output for only 2 seconds. A warning signal is output continuously until the cause of the warning is eliminated. Refer to 9.2.1 *List of Warnings for Command Option Attachable Type SERVOPACKs*.

Type	Signal Name	Connector Pin No.	Setting	Meaning
Output	/WARN	CN1-1, 2	ON (close)	Warning status (Error/warning status)
			OFF (open)	Normal status

The /WARN output status can be set with the parameters below.

Parameter		Meaning	When Enabled
PnB1C	0 [Factory setting]	When an error/warning occurs, photocoupler becomes ON (close).	After restart
	1	When an error/warning occurs, photocoupler becomes OFF (open).	
PnB51	0 [Factory setting]	Does not output /ALO1 to /ALO3. (/WARN, /BK, and /S-RDY are output.)	After restart
	1	Outputs /ALO1 to /ALO3. (/WARN, /BK, and /S-RDY are not output.)	

5.3.7 Positioning Completed Output Signal (/INPOSITION)

This signal indicates that servomotor positioning has been completed.

The signal is output when the motor stops, even if the current position has not reached the target position.

If the difference between the reference from the INDEXER Module and the movement of the servomotor (the number of position error pulses) drops below the value set for this parameter, the positioning completed signal will be output.

Type	Signal Name	Connector Pin No.	Output Status	Meaning
Output	/INPOSITION	CN11-19, 20	ON (close)	Positioning has been completed.
			OFF (open)	Positioning is not completed.

Parameter	Meaning	When Enabled
PnB13	0 [Factory setting]	When positioning has been completed, photocoupler becomes ON (close).
	1	When positioning has been completed, photocoupler becomes OFF (open).

PnB2D	/INPOSITION width			
	Setting Range	Setting Unit	Factory Setting	When Enabled
	0 to 99999	Reference unit	1	Immediately

- The inposition width setting has no effect on final positioning accuracy.

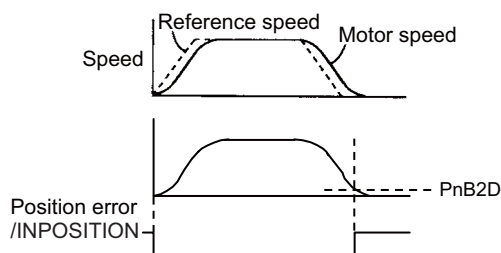

■ Notes when the Positioning Completed State is Established while Canceling a Motion Command

When the SERVOPACK enters any of the following states during execution of a motion command, it may cancel the execution of the motion command and establish the positioning completed state.

- The servo OFF state has been established due to an alarm.
- The servo OFF state has been established because the main power supply was turned OFF.
- The motor has stopped due to overtravel or a software limit.

In this case, the motor has not reached the target position specified by the host controller. Check the current position to confirm that the axis is stopped at a safe position.



IMPORTANT

If the state of an OT signal varies over a short time (in a pulsing manner for example), the host controller may not be able to monitor the variation of the OT signal properly. Take due care about the selection of limit switches and their mounting and wiring to avoid chattering of OT signals and malfunctioning.

5.3.8 Programmable Output Signals (/POUT0 to /POUT7)

The basic use and wiring procedure for the programmable outputs (/POUT0 to /POUT7) are given below. The programmable output signals can be changed by the user through the program table's POUT bits or the POUT serial command.

(1) Signal Specifications

Type	Signal Name	Connector Pin No.	Name
Output	/POUT0	CN11-21, 22	Programmable output 0
	/POUT1	CN11-23, 24	Programmable output 1
	/POUT2	CN11-25, 26	Programmable output 2
	/POUT3	CN11-27, 28	Programmable output 3
	/POUT4	CN11-29, 30	Programmable output 4
	/POUT5	CN11-31, 32	Programmable output 5
	/POUT6	CN11-33, 34	Programmable output 6
	/POUT7	CN11-35, 36	Programmable output 7

(2) Related Parameters

The output statuses of /POUT0 to /POUT7 can be set with the parameters below.

Parameter	Signal Name	Setting	Factory Setting	When Enabled
PnB14	/POUT0	0: When programmable output signal is active, photocoupler becomes ON (close). 1: When programmable output signal is active, photocoupler becomes OFF (open).	0	After restart
PnB15	/POUT1			
PnB16	/POUT2			
PnB17	/POUT3			
PnB18	/POUT4			
PnB19	/POUT5			
PnB1A	/POUT6			
PnB1B	/POUT7			

(3) Setting the Initial Status of Programmable Output Signals (/POUT0 to /POUT7)

With the following parameter, the initial status* of the programmable output signals (/POUT0 to /POUT7) can be set to inactive or to ZONE signals.

* The initial status indicates the status when the control power supply is turned ON or after resetting the SERVOPACK.

Parameter	Meaning	When Enabled
PnB4F	0 [Factory setting]	When control power is turned ON or SERVOPACK is reset, signals /POUT0 to 7 are inactive.
	1	When control power is turned ON or SERVOPACK is reset, signals /POUT0 to 7 are ZONE signals.
		After restart

5.3.9 Encoder Signal Outputs

The encoder signals can be used to monitor the servomotor's speed and position. However, the INDEXER Module manages the servomotor's speed and position so it is not necessary to use the encoder signals to monitor the speed and position from the host controller.

If an absolute encoder is used, the absolute position data is sent only once when the power is turned ON. Normally, do not use this signal.

For details, refer to the following manuals.

- *Σ-V Series User's Manual Design and Maintenance Rotational Motor/Command Option Attachable Type (SIEP S800000 60)*
- *Σ-V Series User's Manual Design and Maintenance Linear Motor/Command Option Attachable Type (SIEP S800000 66)*

5.4 Settings According to Device Characteristics

This section describes the procedure for setting parameters according to the dimensions and performance of the equipment used.

5.4.1 Setting Reference Units

Reference units are the position and distance units that are used between the host controller and INDEXER Module. A reference unit is the minimum unit for positioning. The electronic gear ratio converts encoder pulse units into reference units.

When the Electronic Gear Function is Not Used

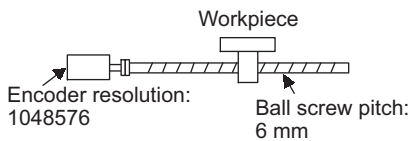

To move a workpiece 10 mm:

One revolution is 6 mm. Therefore,
 $10 \div 6 = 1.6666$ revolutions.
 1048576 pulses make one revolution.
 Therefore,
 $1.6666 \times 1048576 = 1746928$ pulses.
 1746928 pulses are input as references.
 The equation must be calculated at the host controller.

When the Electronic Gear Function is Used

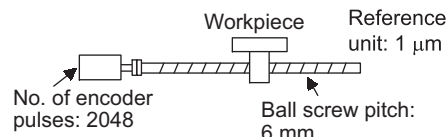

To move a workpiece 10 mm:

Equipment conditions and reference units must be defined for the electronic gear function beforehand.
 Reference unit is 1 μm. Therefore,
 $\frac{10 \text{ mm}}{1 \mu} = 10000$ reference units

(1) Setting Reference Units

Determine the reference unit to be used.

To move table in 0.001-mm unit

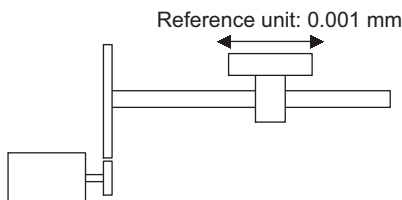

Determine the reference unit according to equipment specifications and positioning accuracy.

<Example>

- 0.01 mm, 0.001 mm, 0.1°, or 0.01 inch.
A reference input of one pulse moves the table by one reference unit.
- When the reference unit is 1 μm
If a reference of 50000 pulses is input, the table moves 50 mm ($50000 \times 1 \mu\text{m}$).

(2) Setting Electronic Gear Ratio

After deciding the reference unit, set the electronic gear ratio.

For details on the setting method, refer to the following manuals.

- *Σ-V Series User's Manual Design and Maintenance Rotational Motor/Command Option Attachable Type* (SIEP S800000 60)
- *Σ-V Series User's Manual Design and Maintenance Linear Motor/Command Option Attachable Type* (SIEP S800000 66)



IMPORTANT

Electronic gear ratio setting range: $1 \leq \text{Electronic gear ratio (B/A)} \leq 4000$
 If a value smaller than 1 is set, the motor may not rotate at its maximum speed.
 And if a value larger than 4000 is set, a "parameter setting error (A.040) alarm" occurs.

(3) Setting Speeds in Reference Units

Calculate the positioning speed.

<Example>

Reference unit: 0.01 mm

Desired positioning speed: 15 m/min

$$\frac{15000 \text{ mm/min}}{0.01 \text{ mm}} = 1500000 \text{ reference units/min}$$

Thus, the positioning speed setting is 1500 [1000 reference units/min].

Specify the positioning speed and registration speed in the program table in SPD and RSPD.

Specify the JOG speed in the JOG speed table in JSPD.

Specify the positioning speed and registration speed with the SPD and RSPD serial commands. The SPD and RSPD commands can be omitted; in this case, the setting in the following parameter will be used.

PnB27	Positioning/Registration Speed			
	Setting Range	Setting Unit	Factory Setting	When Enabled
	1 to 99999999	1000 Reference units/min	1000	After restart

(4) Setting Reference Unit Acceleration/Deceleration, and Average Movement Time of Position References

Calculate the acceleration/deceleration.

<Example>

Reference unit: 0.01 mm

Acceleration time from 0 m/min to 15 m/min: 100 ms

$$\frac{15000 \text{ mm/min}}{0.01 \text{ mm}} = 1500000 \text{ reference units/min}$$

$$\frac{1500000 \text{ reference units/min}}{100 \text{ ms}} = 15000 \text{ [(reference units/min)/ms]}$$

Thus, the acceleration setting is 15 [1000 (reference units/min)/ms].

Using the parameters below, set the acceleration and deceleration, and set the average movement time of position references.

PnB29	Acceleration rate			
	Setting Range	Setting Unit	Factory Setting	When Enabled
	1 to 99999999	1000 (Reference units/min)/ ms	1000	Immediately
PnB2B	Deceleration rate			
	Setting Range	Setting Unit	Factory Setting	When Enabled
	1 to 99999999	1000 (Reference units/min)/ ms	1000	Immediately
Pn217	Average Movement Time of Position Reference			
	Setting Range	Setting Unit	Factory Setting	When Enabled
	0 to 10000	0.1 ms	1000	After the change and also after the motor has stopped

**IMPORTANT**

Set the acceleration and deceleration so that the values of the two settings do not differ greatly.

If they differ greatly, the machine will not accelerate in accordance with the settings.

For example, if PnB29 is set to 99999999 and PnB2B is set to 1, then the machine's performance will be unpredictable.

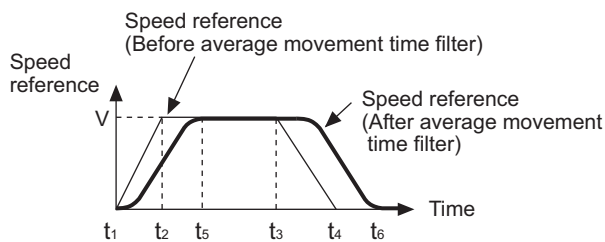

$$\text{Acceleration} = \frac{V}{t_2 - t_1} = \frac{[\times 1000 \text{ reference units/min}]}{[\text{ms}]}$$

$$\text{Deceleration} = \frac{V}{t_4 - t_3} = \frac{[\times 1000 \text{ reference units/min}]}{[\text{ms}]}$$

$$\text{Average movement time of position reference} = t_5 - t_2 = t_6 - t_4$$

5.4.2 Moving Mode and Coordinate Settings

Use the following parameters to set the moving mode and coordinates.

Parameter	Meaning	When Enabled	
PnB20	0 [Factory setting]	Sets coordinates to linear type.	After restart
	1	Sets coordinates to rotary type. Moving mode is set as shortest path.	
	2	Sets coordinates to rotary type. Moving mode is set as always forward.	
	3	Sets coordinates to rotary type. Moving mode is set as always reverse.	

PnB21	Linear Type (PnB20 = 0): Forward Software Limit (P-LS) Rotary Type (PnB20 ≠ 0): End Point of Rotational Coordinates			
	Setting Range	Setting Unit	Factory Setting	When Enabled
	-99999999 to 99999999	Reference unit	99999999	After restart
PnB23	Linear Type (PnB20 = 0): Reverse Software Limit (N-LS) Rotary Type (PnB20 ≠ 0): Starting Point of the Rotational Coordinates			
	Setting Range	Setting Unit	Factory Setting	When Enabled
	-99999999 to 99999999	Reference unit	-99999999	After restart
PnB25	Origin (Incremental Encoder) Absolute Encoder Offset (Absolute Encoder)			
	Setting Range	Setting Unit	Factory Setting	When Enabled
	-99999999 to 99999999	Reference unit	0	After restart

(1) When the Coordinates are the Linear Type

When using the linear type coordinates such as with a ball screw, set PnB20 to 0 and set the forward software limit (P-LS) in PnB21 and the reverse software limit (N-LS) in PnB23.

An error will occur if the positioning target position exceeds one of the software limits. An error will also occur if +/-INFINITE is set for the target position (POS) in the program table.

If the workpiece reaches a software limit during the JOG command or JOG speed table operation, the motor will stop at the deceleration set in PnB2B.

If both PnB21 and PnB23 are set to 0, the software limit function will be disabled.

The software limit function is enabled after completion of homing. If, however, PnB31 is set to 0 (no homing), the software limit function will be enabled when the control power supply is turned ON. The software limit function will also be enabled as soon as the ZSET serial command is executed.



(2) When the Coordinates are the Rotary Type

When using a rotary type coordinates such as with a rotary table, set PnB20 to 1 (shortest path), to 2 (forward), or to 3 (reverse). Then set the end point of rotational coordinates in PnB21 and the starting point of rotational coordinates in PnB23.

The software limit function will be disabled.

If PnB20 is set to 1 (shortest path), the motor will rotate in the shortest direction (forward or reverse) when the target position is specified as an absolute position.

If PnB20 is set to 2 (forward), the motor will always rotate in the forward direction when the target position is specified as an absolute position.

If PnB20 is set to 3 (reverse), the motor will always rotate in the reverse direction when the target position is specified as an absolute position.

If the target position is specified as an relative position, the motor will rotate in the specified direction regardless of the setting of PnB20.

<Example>

• PnB21 = +3599, PnB23 = 0

• PnB21 = +4999, PnB23 = -5000

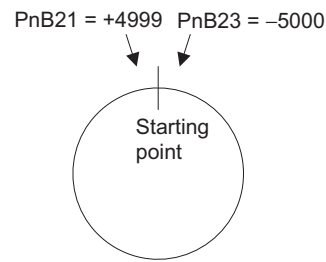
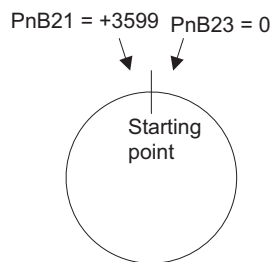

Even when equipment like a rotary table is used, if multiple turns cannot be performed set the coordinate as linear type (PnB20 = 0).

In this case, the values set in PnB21 and PnB23 are the values of the soft limits.



IMPORTANT

When using rotary type coordinates and an absolute encoder, set the multi-turn limit (Pn205).

For details on setting the multi-turn limit, refer to *Σ-V Series User's Manual Design and Maintenance Rotational Motor/Command Option Attachable Type* (SIEP S800000 60).

5.4.3 Setting Home Position

Set the origin or the difference between the reference coordinates and absolute encoder position (the absolute encoder offset) for parameter PnB25.

PnB25	Origin (Incremental Encoder)			
	Absolute Encoder Offset (Absolute Encoder)			
	Setting Range	Setting Unit	Factory Setting	When Enabled
	-99999999 to 99999999	Reference unit	0	After restart

(1) When Using an Incremental Encoder

When the power is turned ON and when homing is completed, the setting for PnB25 is set as the current value.

(2) When Using an Absolute Encoder

Use one of the following methods to set the home position.

- Execute the ZSET serial command.
 - Use the FnB09 utility function.*
- *The function FnB09 is available for the following software versions.
 INDEXER module: Version 3 or later
 SERVOPACK: Version 001B or later
- Set PnB25 to the value calculated with the equation explained in the following section.

The value for PnB25 can be calculated from the following equation.

$$\text{PnB25} = \text{Current setting of PnB25} + \text{nnnnnnnn} - \text{Position reference current position}$$

PnB25: Absolute encoder offset

nnnnnnnn: Desired position (Usually zero)

Position reference current position: Can be monitored with the serial command “PON” or “MON1.”

When using the linear type coordinate (PnB20 = 0), set the calculated value in PnB25.

When using a rotary type coordinate (PnB20 ≠ 0), set the results in PnB25 after performing the following calculations so that the following relationships are satisfied: $\text{PnB23} \leq \text{PnB25} \leq \text{PnB21}$.

- If the results is smaller than PnB23 (the starting point of the rotational coordinates) add the width of the coordinates ($\text{PnB21} - \text{PnB23} + 1$).
- If the results is larger than PnB21 (the end point of the rotational coordinates) subtract the width of the coordinates ($\text{PnB21} - \text{PnB23} + 1$).

Making the above setting will change the current position of the machine to nnnnnnnn.



IMPORTANT

After changing parameter Pn20E, Pn210, Pn205 or PnB20 to PnB25, turn the control power OFF and then ON again to enable the new setting.

5.4.4 Backlash Compensation

This parameter can be set to compensate for positioning offset caused by the backlash of gears.

PnB50	Backlash Compensation			
	Setting Range	Setting Unit	Factory Setting	When Enabled
	-1000 to 1000	Reference unit	0	Immediately

Specify the direction for compensation with the sign and the quantity of the compensation with a numeric value. If the sign is positive, compensation will be applied for forward positioning. If the sign is negative, compensation will be applied for reverse positioning. If the setting is changed, the new setting will be enabled from the next positioning.

When using an incremental encoder, the final direction used in homing generally serves as the reference direction and backlash compensation is applied in the opposite direction.

When using an absolute encoder, the initial direction of movement generally serves as the reference direction and backlash compensation is applied in the opposite direction.

Even when compensation is applied, the compensation will not be indicated in the target position monitor or any other monitor values. Only the actual motor positions will be subject to compensation.

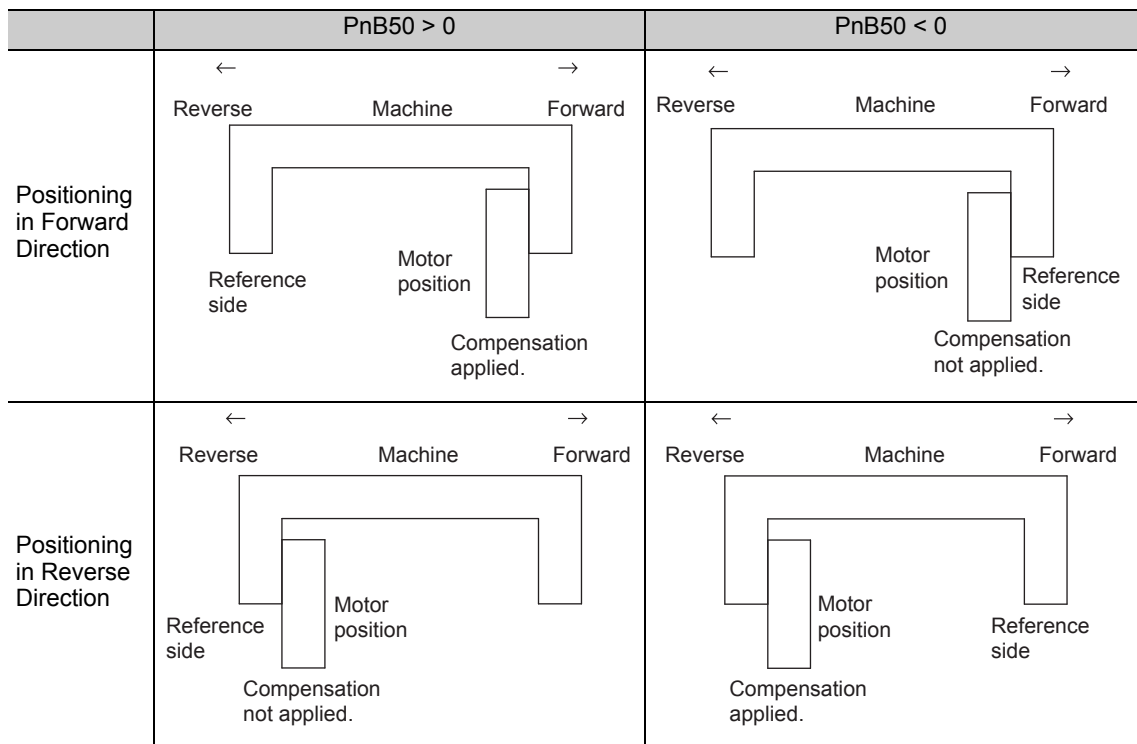

5.4.5 Torque Limit

Only the internal torque limit can be used.

For details, refer to the following manuals.

- *Σ-V Series User's Manual Design and Maintenance Rotational Motor/Command Option Attachable Type (SIEP S800000 60)*
- *Σ-V Series User's Manual Design and Maintenance Linear Motor/Command Option Attachable Type (SIEP S800000 66)*

5.4.6 Fully-closed Loop Control

For more information on the settings for fully-closed loop control, refer to *Σ-V Series User's Manual Design and Maintenance Rotational Motor/Command Option Attachable Type* (SIEP S800000 60).

When using the fully-closed loop control with an INDEXER Module, some restrictions apply to the setting for parameter Pn20A (External Encoder Pitches.)



IMPORTANT

Set parameter Pn20A (External Encoder Pitches) to a value within the recommended range. If a value outside of this range is set, the speed reference may be limited to a value lower than the maximum speed of the motor.

Scale Type	PGTYPE Response	Pn20A Setting Range
8-bit serial converter unit 8-bit scale	PGTYPE = 0000xx08	Pn20A ≤ 65103
9-bit scale	PGTYPE = 0000xx09	Pn20A ≤ 32551
10-bit scale	PGTYPE = 0000xx0A	Pn20A ≤ 16275
13-bit scale	PGTYPE = 0000xx0D	Pn20A ≤ 2034

Program Table

The chapter describes how to set and operate a program table.

6.1 Program Table	6-2
6.1.1 Mode Switch Signal (/MODE 0/1)	6-2
6.1.2 Input Signals for Program Table Operation	6-2
6.1.3 Program Table Step Selection	6-4
6.1.4 Program Table Settings	6-5
6.1.5 Examples of EVENT Conditions	6-8
6.1.6 Program Table Operation	6-9
6.1.7 Status Changes in Program Table Operation	6-10
6.1.8 Input Signal Timing Specifications for Program Table Operation	6-11
6.1.9 Response Times after Turning ON the /START-STOP Signal	6-12
6.1.10 Program Table Examples	6-13
6.2 Registration	6-19
6.2.1 Registration Timing Specifications	6-19
6.2.2 Registration Input Setting	6-20
6.2.3 Registration Operation	6-20
6.3 ZONE Table Settings	6-22
6.4 Homing/JOG Speed Table	6-24
6.4.1 Mode Switch Input Signal (/MODE 0/1)	6-24
6.4.2 Homing/JOG Speed Table Input Signals	6-24
6.4.3 Parameters Related to Homing	6-26
6.5 Homing	6-27
6.6 JOG Speed Table Operation	6-28
6.6.1 Example of JOG Speed Table Operation	6-28
6.6.2 JOG Speed Table	6-29
6.6.3 Input Conditions for Homing and JOG Speed Table Operation	6-30
6.6.4 Input Signal Timing Specifications for Homing and JOG Speed Table Operation	6-30

6.1 Program Table

This section explains program table.

In this section, the word “open” or “close” shown in parentheses in parameter descriptions indicates that the contact is open or closed.

6.1.1 Mode Switch Signal (/MODE 0/1)

If the /MODE 0/1 input signal is active, the mode is set to program table operation mode (Mode 0).

(1) Signal Specifications

Type	Signal Name	Connector Pin No.	Setting	Meaning
Input	/MODE 0/1	CN11-3	ON (close)	Mode 0 (program table operation mode)
			OFF (open)	Mode 1 (homing/JOG speed table operation mode)

(2) Related Parameters

The relationship between the ON/OFF and active/inactive statuses of signals can be set with the parameter below.

Parameter	Meaning	When Enabled	
PnB03	0 [Factory setting]	When input signal is ON (close), mode is set to Mode 0.	After restart
	1	When input signal is OFF (open), mode is set to Mode 0.	
	2	Always Mode 0	
	3	Always Mode 1	

6.1.2 Input Signals for Program Table Operation

(1) Signal Specifications

Type	Signal Name	Connector Pin No.	Setting	Meaning
Input	/START -STOP	CN11-5	ON (close)	Starts program table operation.
			OFF (open)	Stops program table operation.
	/PGMRES	CN11-7	OFF (open) → ON (close)	Resets program table operation. Program table operation is canceled.

Type	Signal Name	Connector Pin No.	Name
Input	/SEL0	CN11-9	Program table selection 0
	/SEL1	CN11-11	Program table selection 1
	/SEL2	CN11-13	Program table selection 2
	/SEL3	CN11-15	Program table selection 3
	/SEL4	CN11-17	Program table selection 4
	/SEL5	CN11-14	Program table selection 5
	/SEL6	CN11-16	Program table selection 6
	/SEL7	CN11-18	Program table selection 7

(2) Related Parameters

Make the settings for program table operation with the parameters below.

Parameter		Meaning	When Enabled
PnB04	0 [Factory setting]	Starts program table operation when /START-STOP signal is ON (close). Stops program table operation when /START-STOP signal is OFF (open).	After restart
	1	Starts program table operation when /START-STOP signal is OFF (open). Stops program table operation when /START-STOP signal is ON (close).	
	2	Does not start program table operation.	
	3		
PnB05	0 [Factory setting]	Resets program table operation by switching /PGMRES signal from OFF (open) to ON (close). Program table operation is canceled.	After restart
	1	Resets program table operation by switching /PGMRES signal from ON (close) to OFF (open). Program table operation is canceled.	
	2	Does not reset program table operation.	
	3		

Parameter	Signal name	Setting	Factory Setting	When Enabled
PnB06	/SEL0	0: When input signal is ON (close), program table selection signal becomes active. 1: When input signal is OFF (open), program table selection signal becomes active. 2: Signal is always active. 3: Signal is always inactive.	0	After restart
PnB07	/SEL1			
PnB08	/SEL2			
PnB09	/SEL3			
PnB0A	/SEL4			
PnB0B	/SEL5			
PnB0C	/SEL6			
PnB0D	/SEL7			

<Notes>

The wiring for the signals, and the parameter settings, described in the table above are not necessary when program table operations are performed with serial commands. The following table shows which serial commands correspond to the various input signals.

Signal	Corresponding Serial Command
/MODE 0/1	None (Mode switching is not necessary.)
/START-STOP	Start: START □□□ command (□□□ = 000 to 255) Stop: STOP command
/SEL0 to /SEL7	Restart: START command
/PGMRES	PGMRES command

6.1.4 Program Table Settings

This section explains the program table settings.

If the edited program table is saved to flash memory, it will be saved even after the control power supply is turned OFF. Use one of the following methods to save the program table to flash memory.

- Execute the PGMSTORE serial command
 - Select “Save Program Table” from SigmaWin+
 - Use the FnB03 utility function * to save program tables
- *The function FnB03 is available for the following software versions.
 INDEXER module: Version 3 or later
 SERVOPACK: Version 001B or later

■ Program Table

PGMSTEP	POS	SPD	RDST	RSPD	ACC	DEC	POUT	EVENT	LOOP	NEXT
0										
1										
2										
⋮	⋮	⋮	⋮	⋮	⋮	⋮	⋮	⋮	⋮	⋮
255										

(1) Program Table Functions

The following table shows the various program table functions.

Item	Function	Description
PGMSTEP	Program step	Number of usable program steps: 256 (0 to 255) The program step can be specified in NEXT.
POS	Target position	<p>I +/-99999999: Relative position (travel distance) specification [reference units] A +/-99999999: Absolute position specification [reference units] +INFINITE: JOG forward operation -INFINITE: JOG reverse operation STOP: Stop (for use with +/-INFINITE operation) S +/-99999999: Continuous stop (Absolute position specification) - : No positioning specified (for POUT only)</p> <p>The factory setting is STOP.</p> <p>Note 1. The +INFINITE and -INFINITE settings can be used only when the rotary type coordinates have been set (PnB20 = 1, 2, or 3) or software limits are not being used (PnB21 = PnB23 = 0). An error will occur if linear type coordinates are being used and a software limit is enabled.</p> <p>2. Continuous stop can be used when the rotary type coordinates have been set (PnB20 = 1, 2, or 3) and the target position specification of the most previous table is +INFINITE or -INFINITE. If the coordinates are the linear type or the target position specification of the most previous table is not +INFINITE or -INFINITE, attempting a continuous stop causes an error. If the speed is changed using the +INFINITE and -INFINITE settings, continuous stop cannot be done.</p>
SPD	Positioning speed	1 to 99999999: Positioning speed [1000 reference units/min] The factory setting is 1000.
RDST	Registration distance	<p>0 to 99999999: Registration distance [reference units] - : No registration</p> <p>The factory setting is “-” for no registration.</p> <p>Note 1. If the change of speed is performed using the +INFINITE and -INFINITE settings, registration cannot be done.</p> <p>2. If a continuous stop is performed, registration cannot be done.</p>

(cont'd)

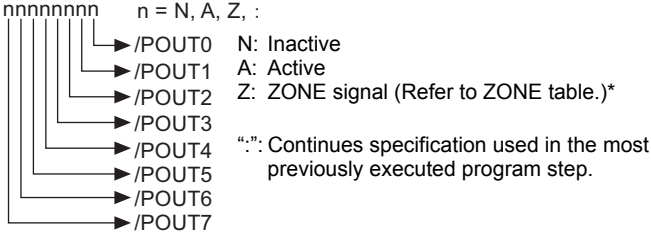
Item	Function	Description
RSPD	Registration speed	1 to 99999999: Registration speed [1000 reference units/min] The factory setting is 1000.
ACC	Acceleration	1 to 99999999: Acceleration [1000 (reference units/min)/ms] “:.”: Continues with acceleration specified in the most previously executed program step. If “:.” is set for the first step in program operation, the last acceleration enabled before the start of program operation (e.g., the acceleration in PnB29 or the acceleration set with the ACC serial command) will be used. The factory setting is “:.”.
DEC	Deceleration	1 to 99999999: Deceleration [1000 (reference units/min)/ms] “:.”: Continues with deceleration specified in the most previously executed program step. If “:.” is set for the first step in program operation, the last deceleration enabled before the start of program operation (e.g., the deceleration in PnB2B or the deceleration set with the DEC serial command) will be used. The factory setting is “:.”.
POUT	Programmable output signals	 <p>When execution of a step is started, the corresponding output signal (/POUT0 to /POUT7) is output. If you want to output the signal at the end of the step, specify POUT as POS = “:.” in the next step.</p>

* It is possible to set a ZONE signal for /POUT5 to 7, but the output is always inactive.

(cont'd)

Item	Function	Description																										
EVENT	Pass condition	<p>Set the condition to use to determine when the program step has been completed. For example, with the factory setting of IT0, the pass condition is met 0 ms after /INPOSITION becomes active.</p> <p>When the pass condition is met, the PGMSTEP that was specified for NEXT will be executed if the number of execution times specified for LOOP has been reached. If the number of execution times specified for LOOP has not been reached, execution is repeated again.</p> <p><Settings> I: /INPOSITION*¹ N: NEAR*¹ D: Position reference distribution completed (DEN)*¹ SELx: Input signal (/SEL0 to /SEL7) active.*^{1, *2} Note: Level detection is used, not edge detection. Tn: Time elapsed (ms) since the program step started.*³ “.”: Continues the previously executed program step’s specification. ITn: Waits for n ms after INPOSITION becomes active.*³ NTn: Waits for n ms after NEAR becomes active.*³ DTn: Waits for n ms after DEN becomes active.*³ SELxTn: Waits for n ms after SELx becomes active.*^{2, *3}</p> <p>The factory setting is IT0. *1. The I, N, D, and SELx parameters can be combined with Tn. If n = 0, then including Tn will not change the results. *2. x = 0 to 7 *3. n = 0 to 99999 Refer to 6.1.5 <i>Examples of EVENT Conditions</i> if necessary.</p> <p>The following parameters set the INPOSITION and NEAR detection widths.</p> <table border="1"> <thead> <tr> <th rowspan="3">PnB2D</th> <th colspan="4">/INPOSITION Width</th> </tr> <tr> <th>Setting Range</th> <th>Setting Unit</th> <th>Factory Setting</th> <th>When Enabled</th> </tr> </thead> <tbody> <tr> <td>0 to 99999</td> <td>Reference unit</td> <td>1</td> <td>Immediately</td> </tr> </tbody> </table> <table border="1"> <thead> <tr> <th rowspan="3">PnB2F</th> <th colspan="4">/NEAR Width</th> </tr> <tr> <th>Setting Range</th> <th>Setting Unit</th> <th>Factory Setting</th> <th>When Enabled</th> </tr> </thead> <tbody> <tr> <td>0 to 99999</td> <td>Reference unit</td> <td>1</td> <td>Immediately</td> </tr> </tbody> </table>	PnB2D	/INPOSITION Width				Setting Range	Setting Unit	Factory Setting	When Enabled	0 to 99999	Reference unit	1	Immediately	PnB2F	/NEAR Width				Setting Range	Setting Unit	Factory Setting	When Enabled	0 to 99999	Reference unit	1	Immediately
PnB2D	/INPOSITION Width																											
	Setting Range	Setting Unit		Factory Setting	When Enabled																							
	0 to 99999	Reference unit	1	Immediately																								
PnB2F	/NEAR Width																											
	Setting Range	Setting Unit	Factory Setting	When Enabled																								
	0 to 99999	Reference unit	1	Immediately																								
LOOP	Number of executions	<p>Specifies the number of execution of the program step. Setting range: 1 to 99999 The factory setting is 1. Note: The NEXT parameter is referenced after the number of LOOP repetitions are completed. The LOOP specification cannot apply to more than one PGMSTEP.</p>																										
NEXT	PGMSTEP to be executed next	<p>0 to 255: Jump to the specified PGMSTEP. END: Ends program table operation. (Program table operation will be canceled.) The factory setting is END.</p>																										

- Note 1. An error (E53E) will occur and program table operation will be stopped if a new positioning command is received during positioning. To restart, turn the /START-STOP signal OFF and then ON again. The execution will be started from the next step when restarting.
2. When the target position (POS) is +INFINITE or -INFINITE and the registration distance (RDST) is “-”, the Speed can be changed by executing the next PGMSTEP. In this case, the motor speed will shift to the new speed. In all other cases, the speed cannot be changed by executing the next PGMSTEP and an error will occur (E53E) if an attempt is made to do so.
3. Program table settings can be changed only when program table operation is canceled. Program table settings cannot be changed during program table operating or stopping even if the PGMSTEP has not been executed and an error will occur (E5EE).

6.1.5 Examples of EVENT Conditions

The following figures show examples of EVENT conditions.

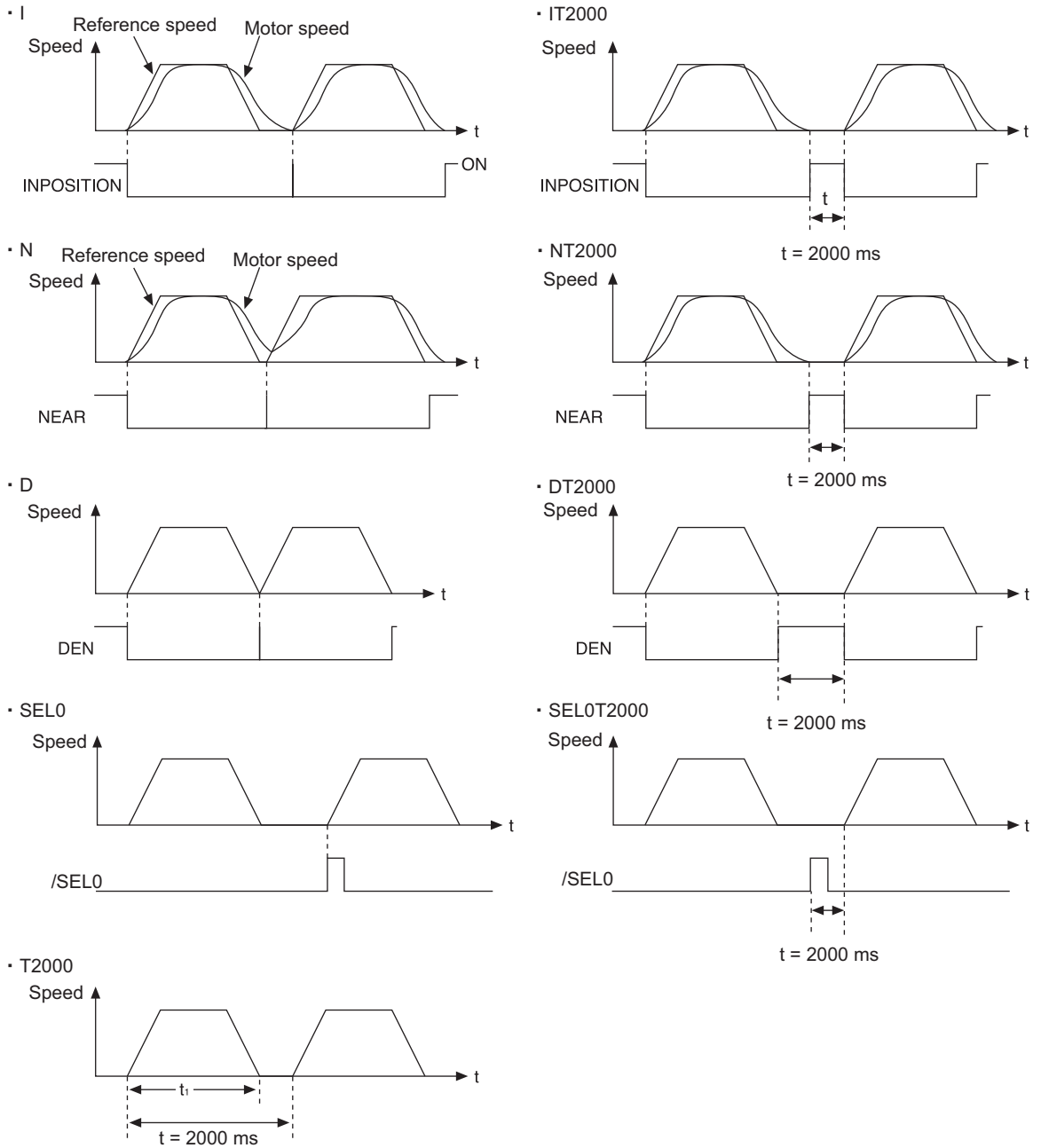

Note: If $t < t_1$, an error (E53E) will occur and program table operation will be stopped.

6.1.6 Program Table Operation

(1) Starting and Stopping the Program

If the /START-STOP signal becomes active when program table operation has been canceled, /SEL0 to /SEL7 will be latched and the program will be executed from the PGMSTEP specified with /SEL0 to /SEL7.

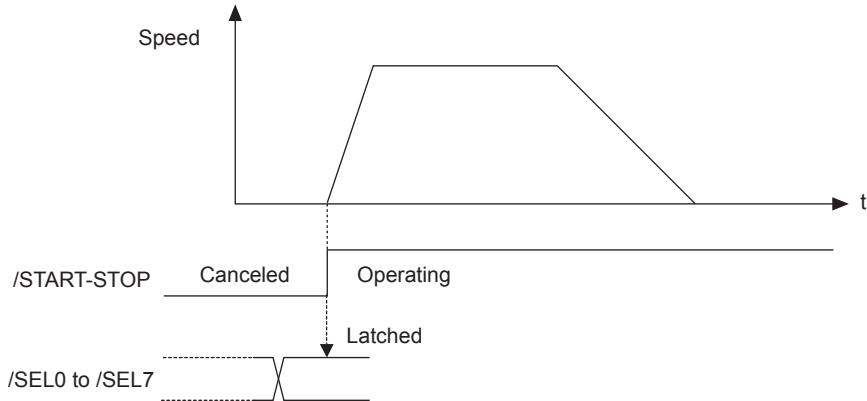

If the /START-STOP returns to inactive state, the program will be stopped and the motor will stop (positioning will be stopped).

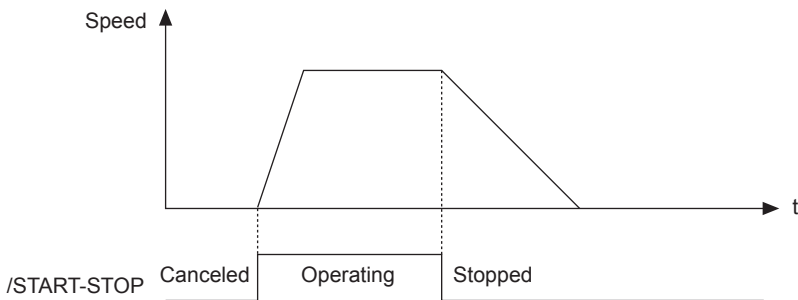

If the /START-STOP becomes active again while the program is stopped, the program (positioning) will be restarted. /SEL0 to /SEL7 will not be latched at this time.

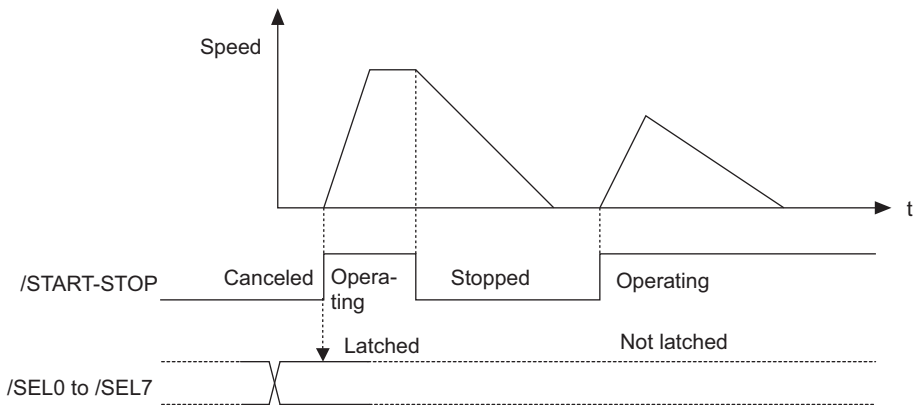

The program will be restarted even if the motor is decelerating.

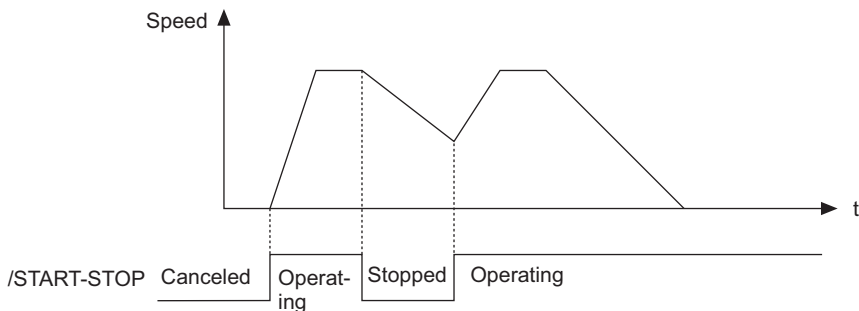

(2) Resetting the Program

The program will be canceled if the /PGMRES signal becomes active while the program is stopped (when the /PGMRES signal is on the rising edge and the /START-STOP signal is inactive.)

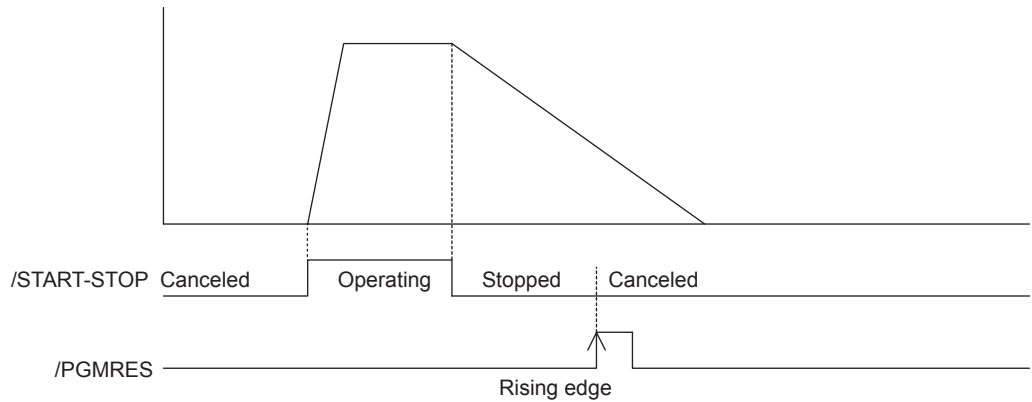

6.1.7 Status Changes in Program Table Operation

There are three different statuses for program table operation. The initial status is “canceled.”

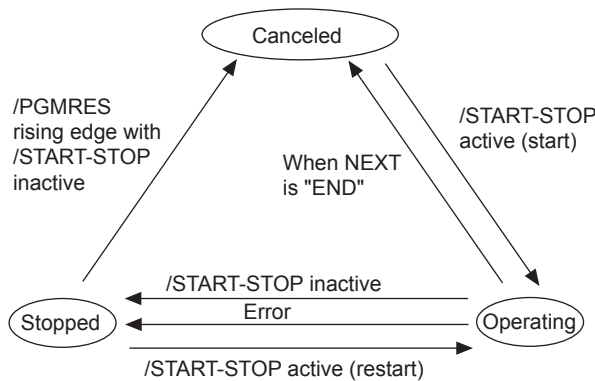

The following table shows the status changes that can occur during program table operation.

Status	/START-STOP	/PGMRES	Operation
Canceled	Inactive → Active	Inactive or Active	Start (Latch specified signal between /SEL0 and /SEL7.)
Operating (Started or restarted)	Active → Inactive	Inactive or Active	Stop
Stopped	Inactive	Inactive → Active	Cancel
	Inactive → Active	Inactive or Active	Restart

Note: If the program table operation is restarted after it stopped because of an error, the PGMSTEP in which the error occurred will be skipped and execution will be restarted from the PGMSTEP specified by NEXT. (If the operation has not been executed for the number of times specified in the LOOP, the next LOOP will be executed.)

6.1.8 Input Signal Timing Specifications for Program Table Operation

The following figures show the timing specifications of program table input signals.

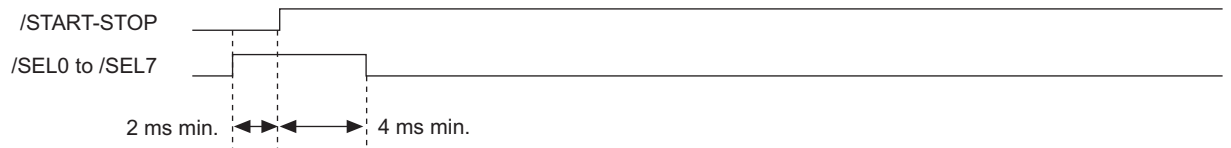
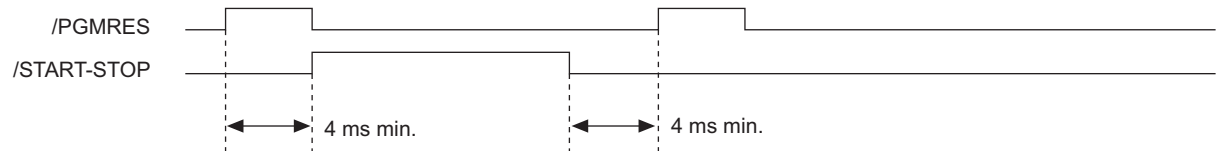
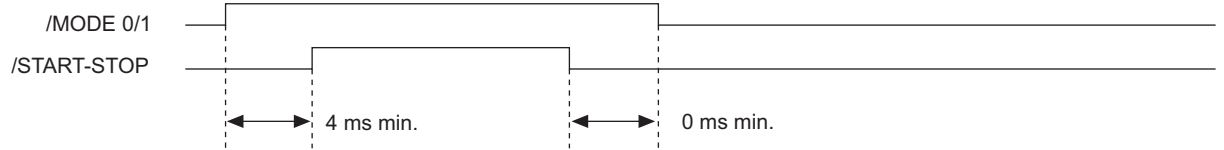

- When /SEL0 to /SEL7 are specified in EVENT

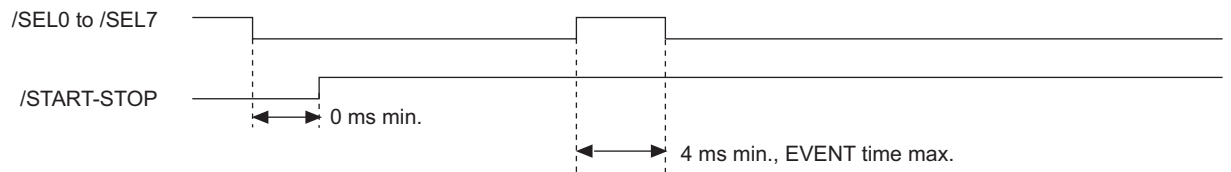

6.1.9 Response Times after Turning ON the /START-STOP Signal

The response times after turning ON the /START-STOP signal are shown below.

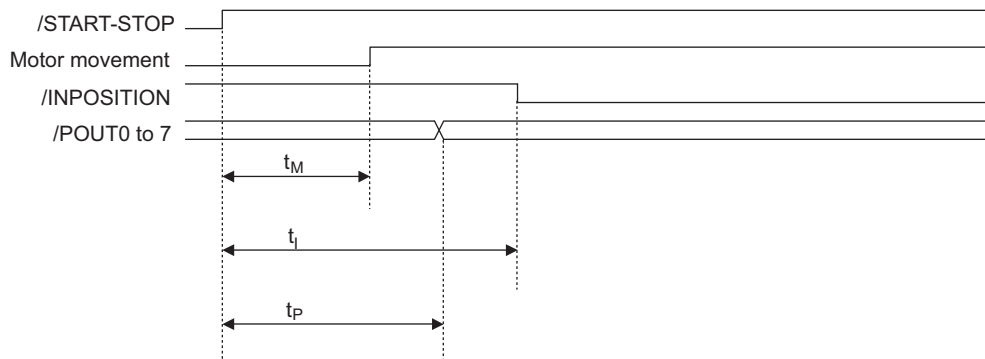

Time	Normal	Under Special Conditions*
t_M	2 ms to 6 ms	2 ms to 16 ms
t_I	2 ms to 8 ms	2 ms to 14 ms
t_P	2 ms to 6 ms	2 ms to 10 ms

* Special Conditions

- Program is stopped due to error.
- Previous positioning was stopped.
- Previous external latch is on standby.
- Overtravel status exists.

6.1.10 Program Table Examples

This section provides examples of program tables.

(1) Simple Round-trip Operation

PGMSTEP	POS	SPD	RDST	RSPD	ACC	DEC	POUT	EVENT	LOOP	NEXT
0	I+200000	15000	-	1000	:	:	NNNNNNNA	IT2000	1	1
1	I-200000	30000	-	1000	:	:	NNNNNNAN	IT2000	2	0

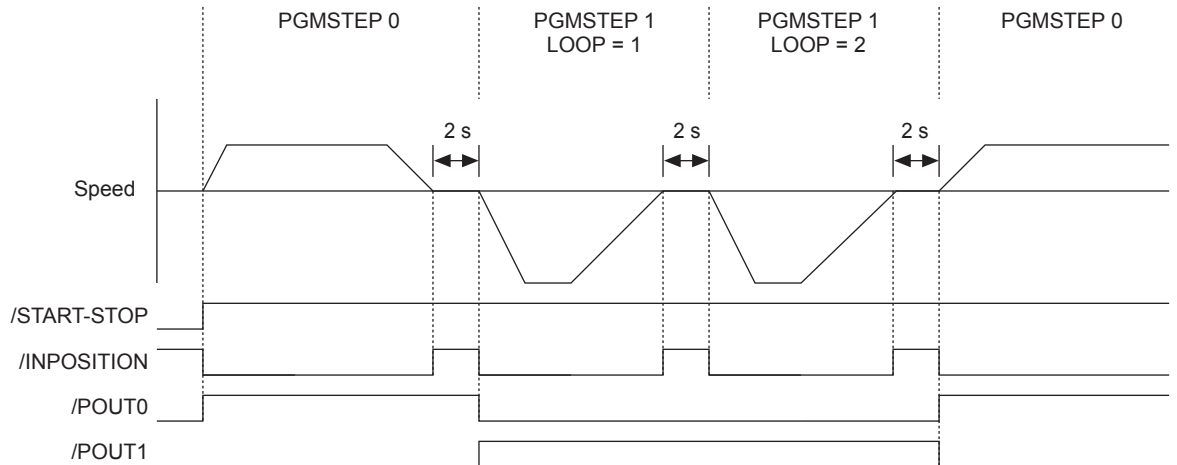

(2) Output /POUTx Signal for the Specified Time after Positioning Completed

PGMSTEP	POS	SPD	RDST	RSPD	ACC	DEC	POUT	EVENT	LOOP	NEXT
0	I+200000	15000	-	1000	:	:	NNNNNNNNN	IT0	1	1
1	-	15000	-	1000	:	:	::::::::A	T2000	1	2
2	I-200000	30000	-	1000	:	:	NNNNNNNNN	IT0	1	3
3	-	30000	-	1000	:	:	::::::::A:	T2000	1	4
4	I-200000	30000	-	1000	:	:	NNNNNNNNN	IT0	1	5
5	-	30000	-	1000	:	:	::::::::A::	T2000	1	0

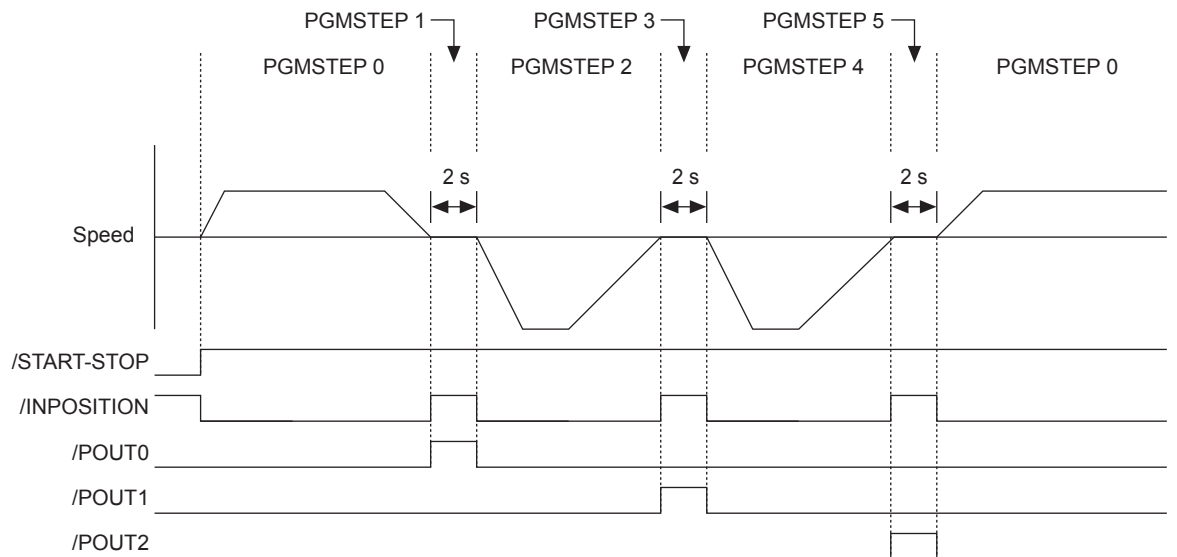

(3) Using /SELx Signal with EVENT Function

PGMSTEP	POS	SPD	RDST	RSPD	ACC	DEC	POUT	EVENT	LOOP	NEXT
0	I+200000	15000	-	1000	:	:	NNNNNNNA	SEL0T2000	1	1
1	I-200000	30000	-	1000	:	:	NNNNNNAN	SELIT2000	2	0

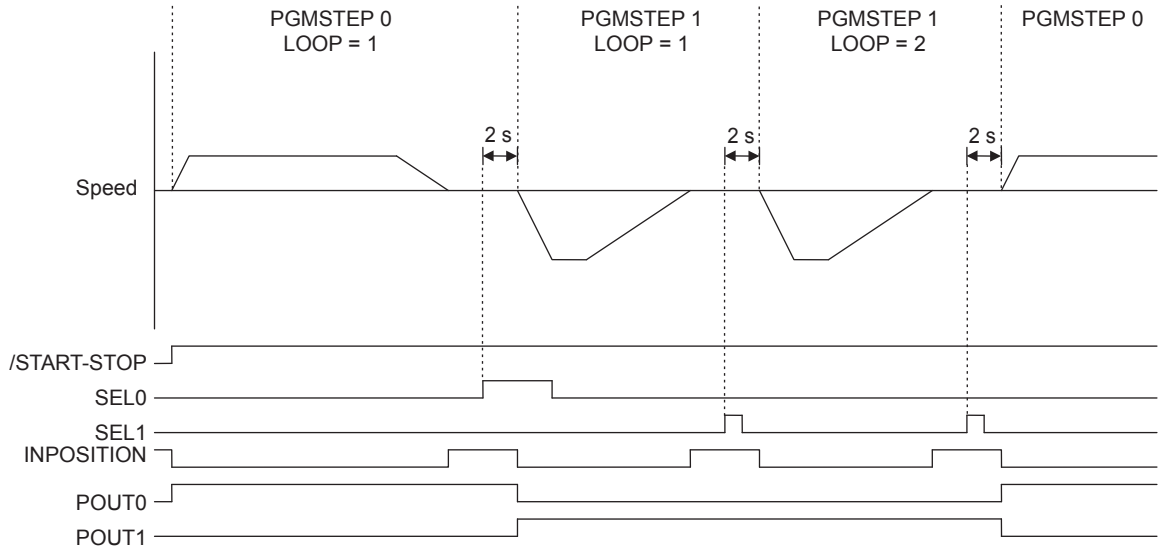

(4) Using ZONE Table

PGMSTEP	POS	SPD	RDST	RSPD	ACC	DEC	POUT	EVENT	LOOP	NEXT
0	A+500000	30000	-	1000	:	:	NNNZZZZZ	IT0	1	1
1	A+000000	30000	-	1000	:	:	NNNZZZZZ	IT0	1	0

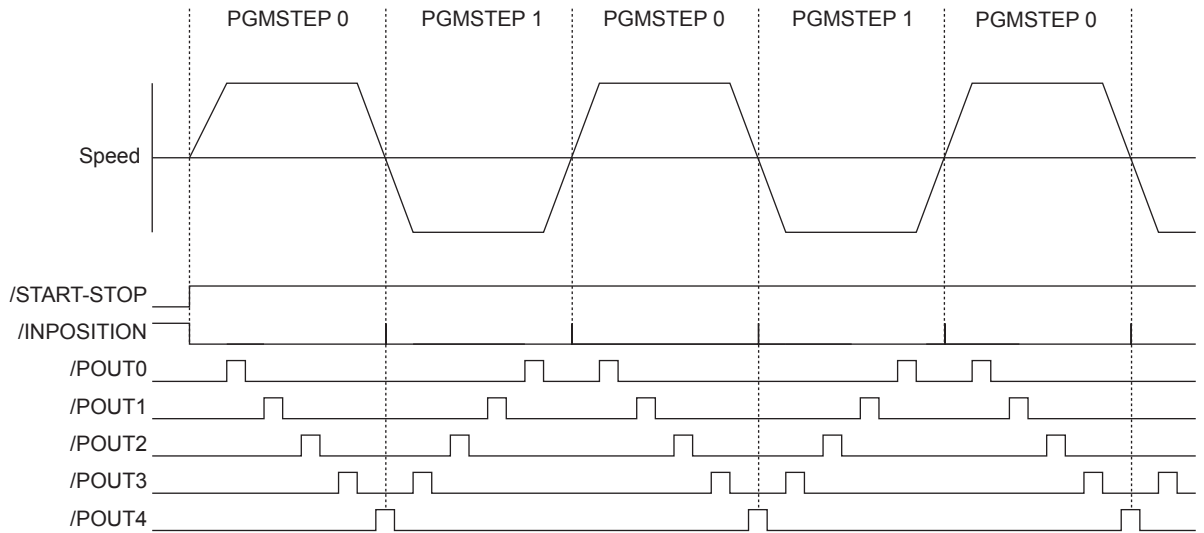

■ ZONE Table

	ZONEN	ZONEP
0	0	0
1	+099995	+100004
2	+199995	+200004
3	0	0
4	+299995	+300004
5	0	0
6	0	0
7	0	0
8	+399995	+400004
9	0	0
10	0	0
11	0	0
12	0	0
13	0	0
14	0	0
15	0	0

	ZONEN	ZONEP
16	+499995	+500004
17	0	0
18	0	0
19	0	0
20	0	0
21	0	0
22	0	0
23	0	0
24	0	0
25	0	0
26	0	0
27	0	0
28	0	0
29	0	0
30	0	0
31	0	0

(5) Using as Positioning Table

PGMSTEP	POS	SPD	RDST	RSPD	ACC	DEC	POUT	EVENT	LOOP	NEXT
0	A+000000	30000	-	1000	:	:	NNNAZZZZ	IT0	1	END
1	A+100000	30000	-	1000	:	:	NNNNZZZZ	IT0	1	END
2	A+200000	30000	-	1000	:	:	NNNAZZZZ	IT0	1	END
3	A+300000	30000	-	1000	:	:	NNNNZZZZ	IT0	1	END
4	A+400000	30000	-	1000	:	:	NNNAZZZZ	IT0	1	END

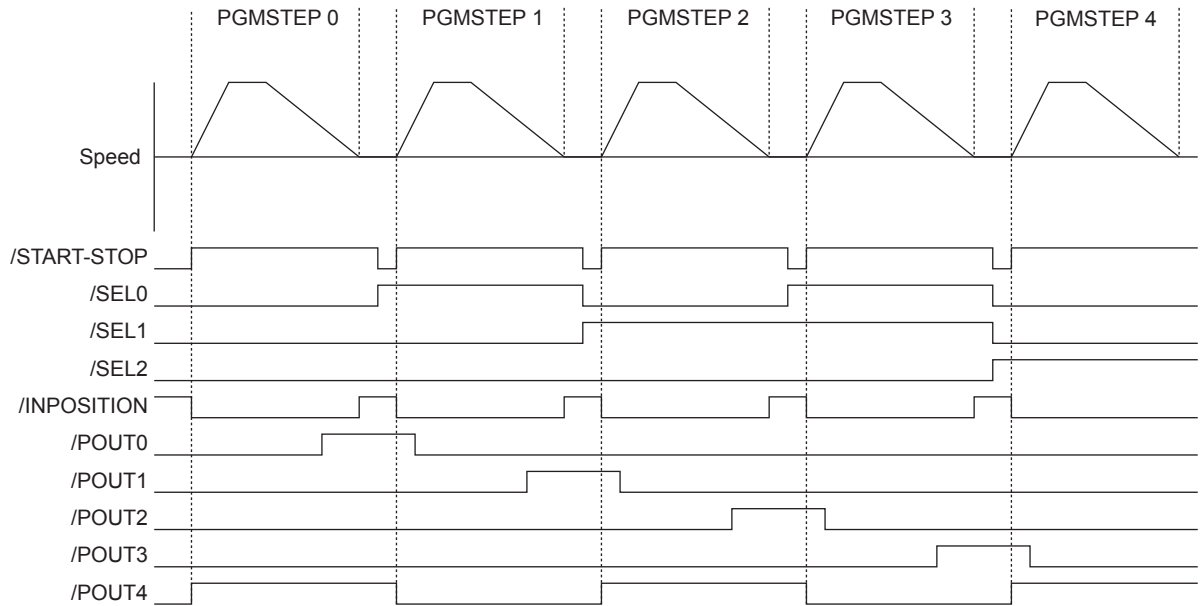

■ Zone Table

	ZONEN	ZONEP
0	0	0
1	-001000	+001000
2	+099000	+101000
3	0	0
4	+199000	+201000
5	0	0
6	0	0
7	0	0
8	+299000	+301000
9	0	0
10	0	0
11	0	0
12	0	0
13	0	0
14	0	0
15	0	0

	ZONEN	ZONEP
16	+399000	+401000
17	0	0
18	0	0
19	0	0
20	0	0
21	0	0
22	0	0
23	0	0
24	0	0
25	0	0
26	0	0
27	0	0
28	0	0
29	0	0
30	0	0
31	0	0

(6) Using INFINITE

PGMSTEP	POS	SPD	RDST	RSPD	ACC	DEC	POUT	EVENT	LOOP	NEXT
0	+INFINITE	15000	-	1000	:	:	NNNNNNNN	T2000	1	1
1	+INFINITE	30000	-	1000	:	:	SEL0TO	1	2
2	STOP	30000	-	1000	:	:	IT0	1	3
3	A+400000	30000	-	1000	:	:	SEL1TO	1	0

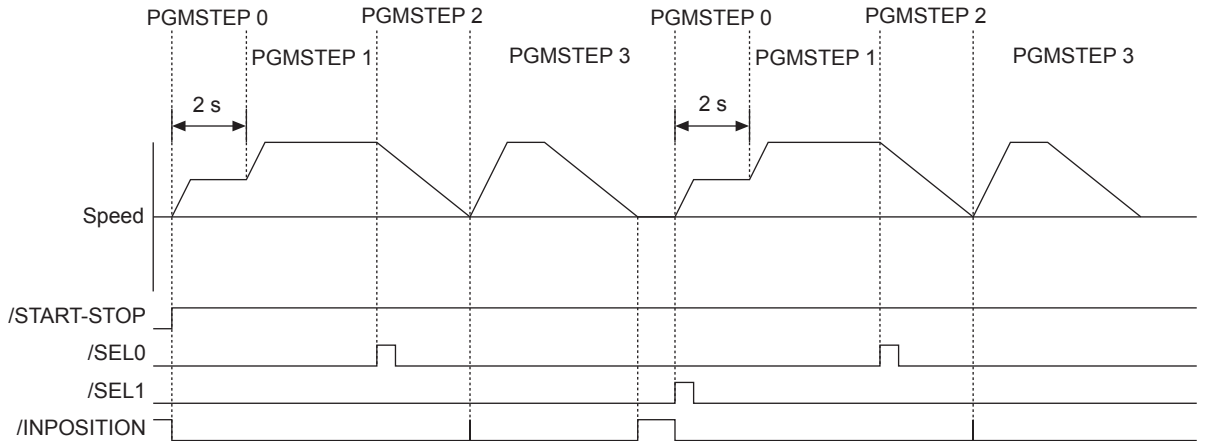

(7) Using Registration

Refer to 6.2 Registration for details on the Registration function.

PGMSTEP	POS	SPD	RDST	RSPD	ACC	DEC	POUT	EVENT	LOOP	NEXT
0	I+200000	30000	100000	15000	:	:	NNNNNNNN	IT0	1	1
1	I-200000	30000	100000	15000	:	:	IT0	1	0

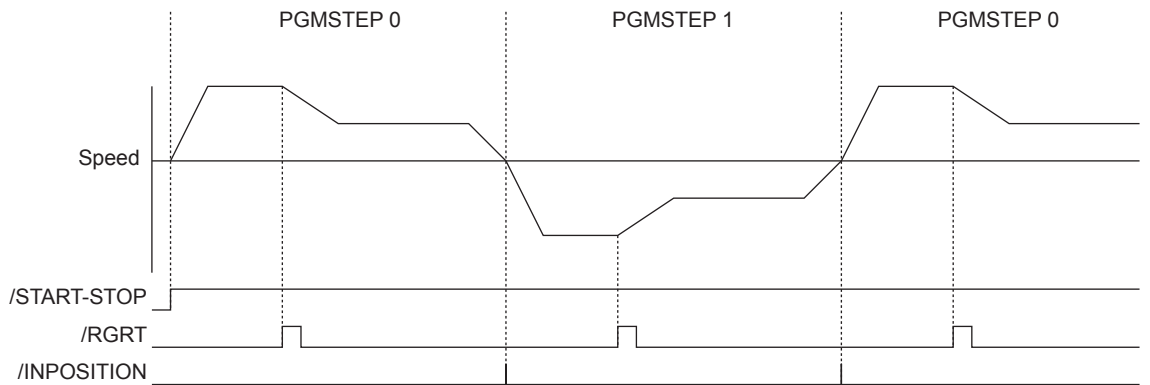

(8) Using Continuous Stop Function

PGMSTEP	POS	SPD	RDST	RSPD	ACC	DEC	POUT	EVENT	LOOP	NEXT
0	+INFINITE	1080000	–	–	1080	1080* ¹	NNNNNNNA	T2000	1* ²	1
1	S+45000	1000* ³	–	–	1080* ⁴	1080	NNNNNNAN	SEL5T0	1* ²	END

- *1. When using the continuous stop function, the Deceleration (DEC) specified in the preceding program step is disabled. The servomotor decelerates at the set rate in the program step specified by the continuous stop function.
- *2. Can only be set to 1.
- *3. When using the continuous stop function, the Positioning Speed (SPD) is disabled. The servomotor moves at the set rate specified in the preceding program step.
- *4. When using the continuous stop function, the Acceleration (ACC) is disabled. The servomotor accelerates at the set rate specified in the preceding program step.

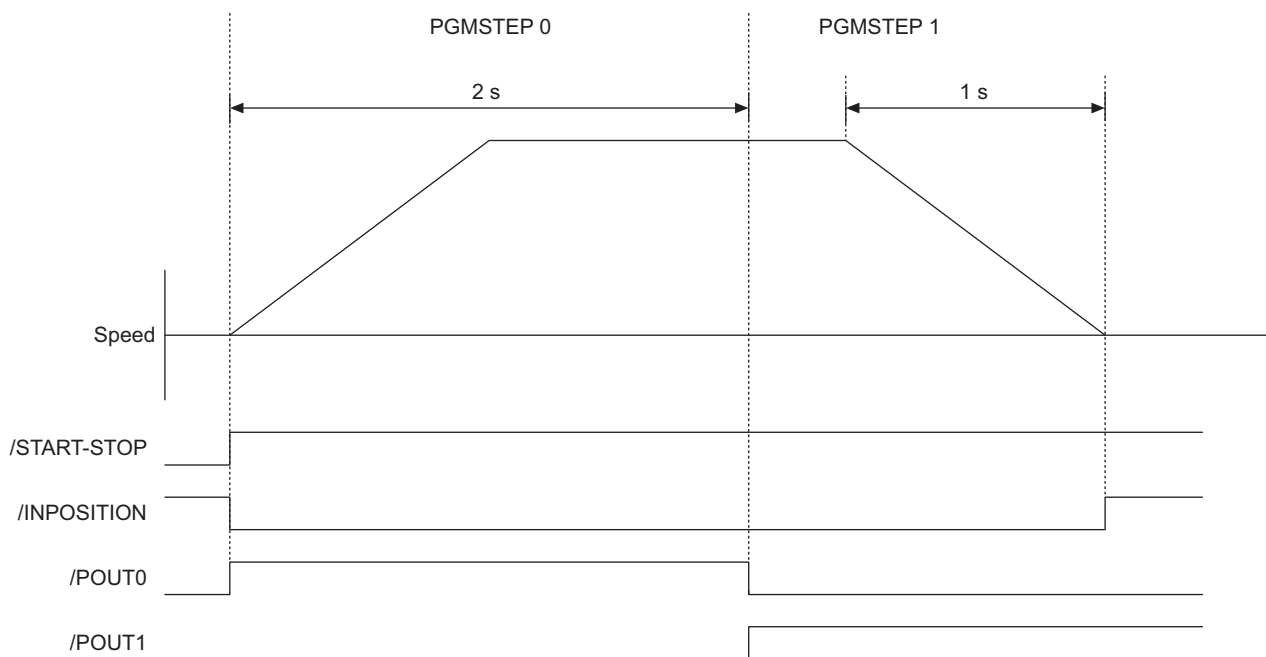

■ Continuous Stop Function

With the continuous stop function, the servomotor decelerates to a stop at the specified position (absolute position specification) in rotational coordinates after a step has been finished when a \pm INFINITE command is used to jog forward or to jog reverse in operations using a program table.

The servomotor rotates at the positioning speed (SPD) set in the preceding program step until the point where deceleration starts. The servomotor stops at the target point in rotational coordinates without rotating in reverse.

The figure shows an example where the servomotor runs at a constant speed in program step 0 for two seconds and positions the servomotor at a 45 degree (reference unit = 0.001 degree) in program step 1.

Note: To use the continuous stop function, the following conditions must be met.

- A rotational coordinate must be used. (PnB20 = 1, 2, or 3)
- The target position of the preceding program step must be \pm INFINITE.
- The \pm INFINITE (POS) setting must not be used in two consecutive steps.
- The Registration function must not be used in the preceding program step.

If these conditions are not met, one of the following errors will occur.

- Move Reference Duplication Error (E53E)
- Continuous Stop Execution Disabled Error (E63E)

6.2 Registration

Positioning is performed for the specified distance and specified speed from the position where the /RGRT signal is latched.

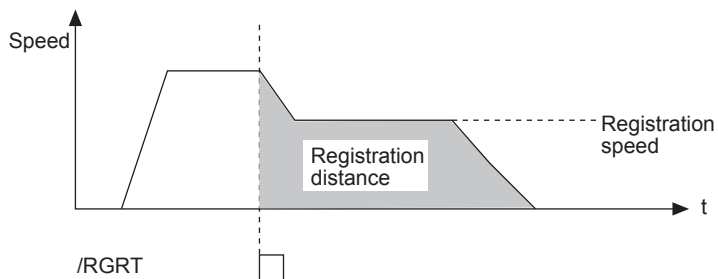

6.2.1 Registration Timing Specifications

The following figure shows the latch timing specifications.

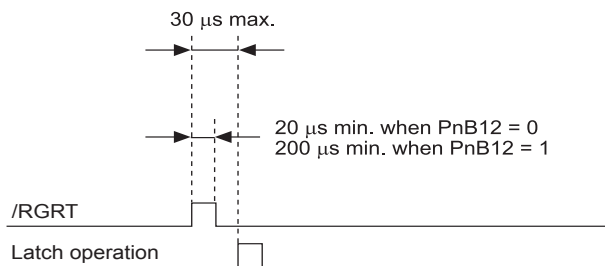

- Shifting to registration operation

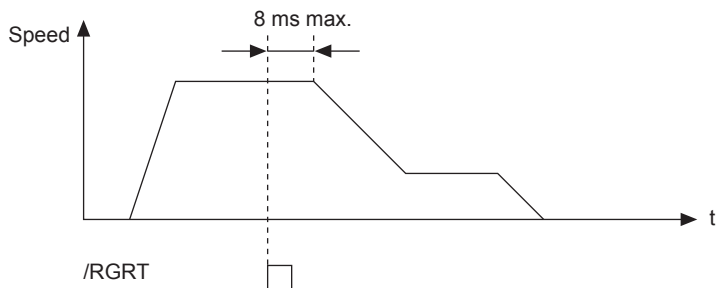

6.2.2 Registration Input Setting

Parameter PnB12 sets the logic for the /RGRT Registration Latch Signal.

(1) Signal Specifications

Type	Signal Name	Connector Pin No.	Setting	Meaning
Input	/RGRT	CN1-12	ON (close)	The current position has reached the latch position.
			OFF (open)	The current position has not reached the latch position, or has passed the latch position.

(2) Related Parameters

The /RGRT signal can be set with the parameter below.

Parameter	Meaning	When Enabled	
PnB12	0 [Factory setting]	Starts registration by switching input signal from OFF (open) to ON (close).	After restart
	1	Starts registration by switching input signal from ON (close) to OFF (open).	
	2	Does not start registration.	
	3		

6.2.3 Registration Operation

If the /RGRT signal becomes active (latches) during positioning, operation will proceed from the latch position to the registration distance only. The registration distance is specified in RDST.

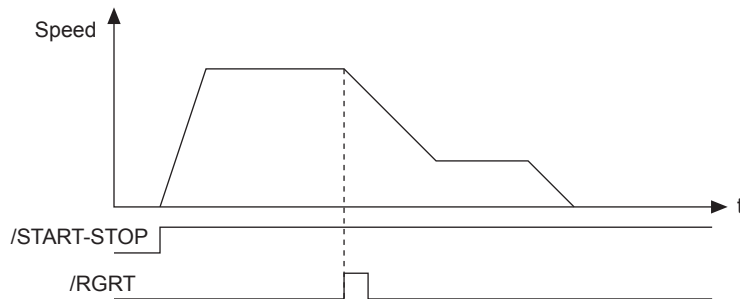

Alarm E23A will occur when the registration distance is too short, i.e., when positioning will go too far even if deceleration begins immediately. When alarm E23A occurs, the servo will go OFF and the program will stop.

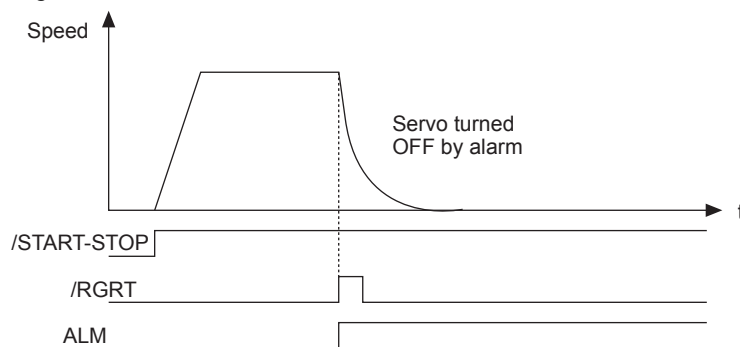

The second and later latch signals are ignored.

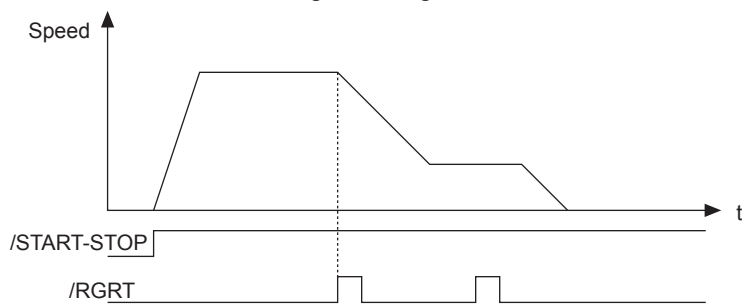

The /RGRT latch signal can also be input while the program is stopped.

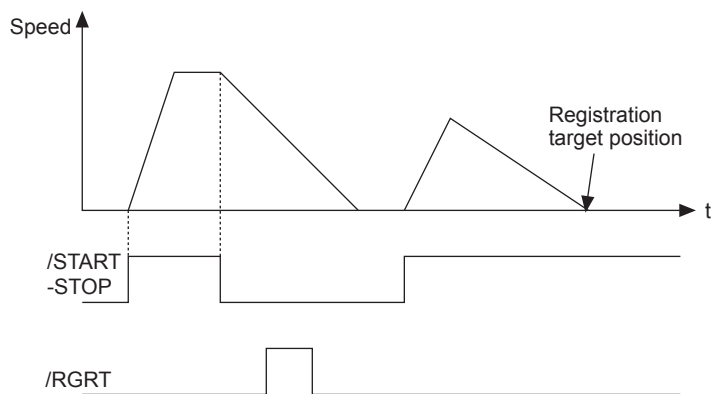

Even if the program is stopped during registration operation, the registration operation will be restarted if the program is restarted.

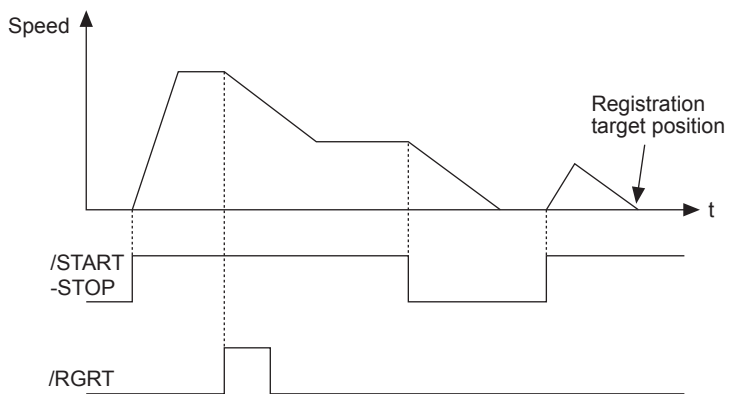

6.3 ZONE Table Settings

ZONE signals indicate regions defined in the ZONE table. ZONE signals are allocated to the regions using the ZONE table.

Outputs /POUT0 to /POUT4 must be specified as ZONE signals in order to use ZONE signals.

If the edited ZONE table is saved to flash memory, it will be saved even after the control power supply is turned OFF. Use one of the following methods to save the ZONE table to flash memory.

- Execute the ZONESTORE serial command
 - Select “Save ZONE Table” from SigmaWin+
 - Use the FnB04 utility function* to save ZONE tables
- *The function FnB04 is available for the following software versions.
 INDEXER module: Version 3 or later
 SERVOPACK: Version 001B or later

ZONE Table

ZONE ID	ZONE N	ZONE P	Z4	Z3	Z2	Z1	Z0
0	±nnnnnnnn	±nnnnnnnn	---	---	---	---	---
1	±nnnnnnnn	±nnnnnnnn	---	---	---	---	Active
2	±nnnnnnnn	±nnnnnnnn	---	---	---	Active	---
3	±nnnnnnnn	±nnnnnnnn	---	---	---	Active	Active
4	±nnnnnnnn	±nnnnnnnn	---	---	Active	---	---
5	±nnnnnnnn	±nnnnnnnn	---	---	Active	---	Active
6	±nnnnnnnn	±nnnnnnnn	---	---	Active	Active	---
7	±nnnnnnnn	±nnnnnnnn	---	---	Active	Active	Active
8	±nnnnnnnn	±nnnnnnnn	---	Active	---	---	---
9	±nnnnnnnn	±nnnnnnnn	---	Active	---	---	Active
10	±nnnnnnnn	±nnnnnnnn	---	Active	---	Active	---
11	±nnnnnnnn	±nnnnnnnn	---	Active	---	Active	Active
12	±nnnnnnnn	±nnnnnnnn	---	Active	Active	---	---
13	±nnnnnnnn	±nnnnnnnn	---	Active	Active	---	Active
14	±nnnnnnnn	±nnnnnnnn	---	Active	Active	Active	---
15	±nnnnnnnn	±nnnnnnnn	---	Active	Active	Active	Active
16	±nnnnnnnn	±nnnnnnnn	Active	---	---	---	---
17	±nnnnnnnn	±nnnnnnnn	Active	---	---	---	Active
18	±nnnnnnnn	±nnnnnnnn	Active	---	---	Active	---
19	±nnnnnnnn	±nnnnnnnn	Active	---	---	Active	Active
20	±nnnnnnnn	±nnnnnnnn	Active	---	Active	---	---
21	±nnnnnnnn	±nnnnnnnn	Active	---	Active	---	Active
22	±nnnnnnnn	±nnnnnnnn	Active	---	Active	Active	---
23	±nnnnnnnn	±nnnnnnnn	Active	---	Active	Active	Active
24	±nnnnnnnn	±nnnnnnnn	Active	Active	---	---	---
25	±nnnnnnnn	±nnnnnnnn	Active	Active	---	---	Active
26	±nnnnnnnn	±nnnnnnnn	Active	Active	---	Active	---
27	±nnnnnnnn	±nnnnnnnn	Active	Active	---	Active	Active
28	±nnnnnnnn	±nnnnnnnn	Active	Active	Active	---	---
29	±nnnnnnnn	±nnnnnnnn	Active	Active	Active	---	Active
30	±nnnnnnnn	±nnnnnnnn	Active	Active	Active	Active	---
31	±nnnnnnnn	±nnnnnnnn	Active	Active	Active	Active	Active

- Note 1. The “---” symbols indicate an inactive signal status.
2. ZONE ID: ZONE Number
 ZONE N: Negative side ZONE boundary position
 ZONE P: Positive side ZONE boundary position
 Z0 to Z4: If the programmable output signals (/POUT0 to /POUT4) are specified as ZONE signals,
 /POUT0 = Z0, /POUT1 = Z1, /POUT2 = Z2, /POUT3 = Z3, and /POUT4 = Z4.
 3. The status of outputs Z0 to Z4 is defined for each ZONE ID.
 4. The programmable output signals (/POUT0 to /POUT4) must be specified as ZONE signals (“Z”). For example if POUT = ZAZZN, then signals Z1, Z2, and Z4 will be output from programmable outputs /POUT1, /POUT2, and /POUT4.

■ ZONE Signal Conditions

- When $ZONEN \leq ZONEP$, the motor position is within range when $ZONEN \leq \text{motor position} \leq ZONEP$.
- When $ZONEN > ZONEP$, the motor position is within range when the motor position $\geq ZONEN$ or the motor position $\leq ZONEP$.

<Example>

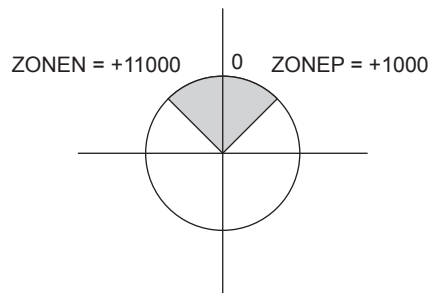

- When the motor position is within range for two or more zones, only the lowest ZONE ID will be effective.
- If the motor position is not within range of any zones, signals Z0 to Z4 will all be inactive.
- A ZONE ID will be disabled if $ZONEN = ZONEP = 0$ is set for that zone.

(1) Setting the Initial Status of Programmable Output Signals (/POUT0 to /POUT7)

With the following parameter, the initial status* of the programmable output signals (/POUT0 to /POUT7) can be set to ZONE signals.

* The initial status indicates the status when the control power supply is turned ON or after resetting the SERVOPACK.

Parameter		Meaning	When Enabled
PnB4F	0 [Factory setting]	When control power is turned ON or SERVOPACK is reset, signals /POUT0 to 7 are inactive.	After restart
	1	When control power is turned ON or SERVOPACK is reset, signals /POUT0 to 7 are ZONE signals.	

Note: It is possible to set a ZONE signal for /POUT5 to 7, but the output is always inactive.

6.4 Homing/JOG Speed Table

6.4.1 Mode Switch Input Signal (/MODE 0/1)

If the /MODE 0/1 input signal is inactive, the mode is set to Mode 1 (homing/JOG speed table operation mode).

(1) Signal Specifications

Type	Signal Name	Connector Pin No.	Setting	Meaning
Input	/MODE 0/1	CN11-3	ON (close)	Mode 0 (program table operation mode)
			OFF (open)	Mode 1 (homing/JOG speed table operation mode)

(2) Related Parameters

The relationship between the ON/OFF and active/inactive statuses of signals can be set with the parameter below.

Parameter	Meaning	When Enabled	
PnB03	0 [Factory setting]	When input signal is ON (close), mode is set to Mode 0.	After restart
	1	When input signal is OFF (open), mode is set to Mode 0.	
	2	Always Mode 0	
	3	Always Mode 1	

6.4.2 Homing/JOG Speed Table Input Signals

(1) Signal Specifications

Type	Signal Name	Connector Pin No.	Setting	Meaning
Input	/HOME	CN11-5	ON (close)	Starts homing.
			OFF (open)	Stops homing.
	/DEC	CN1-10	ON (close)	The deceleration point has been detected.
			OFF (open)	The current position has not reached, or passed the deceleration point.
	/JOGP	CN11-7	ON (close)	Starts forward JOG operation.
			OFF (open)	Stops JOG operation.
/JOGN	CN11-9	ON (close)	Starts reverse JOG operation.	
		OFF (open)	Stops JOG operation.	

Type	Signal Name	Connector Pin No.	Name
Input	/JOG0	CN11-11	JOG speed table selection 0
	/JOG1	CN11-13	JOG speed table selection 1
	/JOG2	CN11-15	JOG speed table selection 2
	/JOG3	CN11-17	JOG speed table selection 3

(2) Related Parameters

The homing/JOG speed table operation signal can be set with the following parameters.

Parameter		Meaning	When Enabled
PnB04	0 [Factory setting]	Starts homing when input signal is ON (close).	After restart
	1	Starts homing when input signal is OFF (open).	
	2, 3	Does not start homing.	
PnB05	0 [Factory setting]	Executes JOG operation in forward direction when input signal is ON (close).	
	1	Executes JOG operation in forward direction when input signal is OFF (open).	
	2, 3	Does not execute JOG operation.	
PnB06	0 [Factory setting]	Executes JOG operation in reverse direction when input signal is ON (close).	
	1	Executes JOG operation in reverse direction when input signal is OFF (open).	
	2, 3	Does not execute JOG operation.	
PnB11	0 [Factory setting]	Starts deceleration in homing when input signal is ON (close).	
	1	Starts deceleration in homing when input signal is OFF (open).	
	2	Sets homing limit switch always ON.	
	3	Sets homing limit switch OFF.	

Parameter	Signal Name	Setting	Factory Setting	When Enabled
PnB07	/JOG0	0: When input signal is ON (close), JOG speed table selection signal becomes active. 1: When input signal is OFF (open), JOG speed table selection signal becomes active. 2: JOG speed table selection signal is always active. 3: JOG speed table selection signal is always inactive.	0	After restart
PnB08	/JOG1			
PnB09	/JOG2			
PnB0A	/JOG3			

6.4.3 Parameters Related to Homing

Set the homing parameters with the parameters listed in the following table.

PnB25	Origin (Incremental Encoder) Absolute Encoder Offset (Absolute Encoder)			
	Setting Range	Setting Unit	Factory Setting	When Enabled
	-99999999 to 99999999	Reference unit	0	After restart
PnB33	Homing Moving Speed			
	Setting Range	Setting Unit	Factory Setting	When Enabled
	1 to 99999999	1000 Reference units/min	1000	Immediately
PnB35	Homing Approach Speed			
	Setting Range	Setting Unit	Factory Setting	When Enabled
	1 to 99999999	1000 Reference units/min	1000	Immediately
PnB37	Homing Creep Speed			
	Setting Range	Setting Unit	Factory Setting	When Enabled
	1 to 99999999	1000 Reference units/min	1000	Immediately
PnB39	Homing Final Move Distance			
	Setting Range	Setting Unit	Factory Setting	When Enabled
	-99999999 to 99999999	Reference unit	0	Immediately

Parameter		Meaning	When Enabled
PnB31	0 [Factory setting]	Does not execute homing.	After restart
	1	/DEC and phase C are used for homing.	
	2	Only /DEC is used for homing.	
	3	Only phase C is used for homing.	
PnB32	0 [Factory setting]	/HOME or ZRN command is used for homing in forward direction.	Immediately
	1	/HOME or ZRN command is used for homing in reverse direction.	

Note: After having completed homing, the current position where homing stopped will be switched to the setting of PnB25.

6.5 Homing

Homing starts when the /HOME signal becomes active.

Homing stops if the /HOME signal becomes inactive again.

If the /HOME signal becomes active again while the homing is stopped, homing will be restarted from the point where it was interrupted.

The homing will be canceled if operation is switched to JOG speed table mode with the /JOGP signal or /JOGN signal, or the mode is switched with the /MODE 0/1 signal while the homing is stopped.

When parameter PnB31 = 0 (No homing), homing will end as soon as the control power supply is turned ON.

The smaller of the settings in parameter PnB29 (Acceleration) and PnB2B (Deceleration) will be used as the homing acceleration and deceleration rate.

Note 1. When PnB31 is set to 0, homing cannot be done by the /HOME signal. If so, an E5DE error will occur.

2. Homing is available when an incremental encoder is used. When an absolute encoder is used, an E61E error will occur if the /HOME signal is active.

■ /DEC and phase C of the encoder are used for homing (PnB31 = 1).

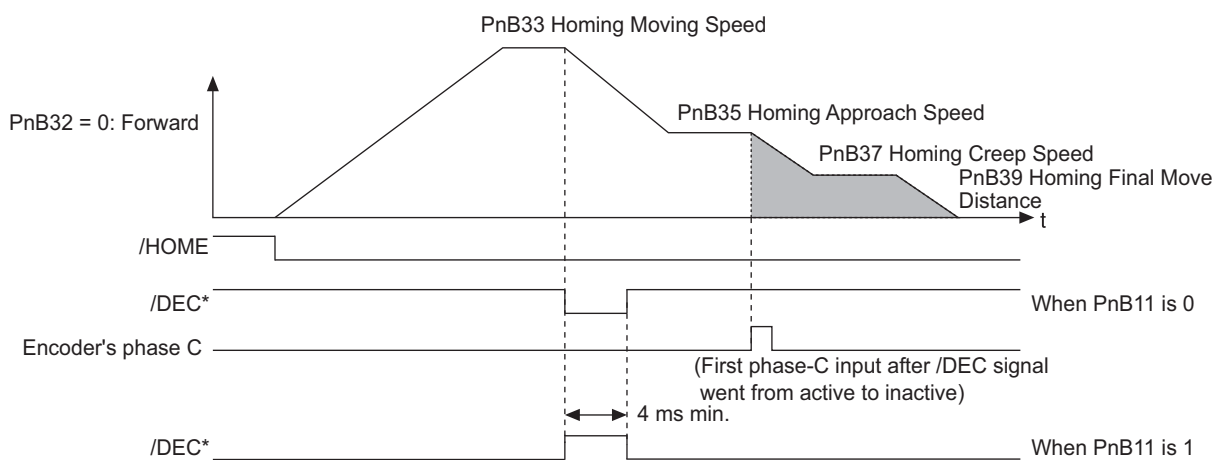

* To change the polarity, use parameter PnB11.

■ Only /DEC is used for homing (PnB31 = 2).

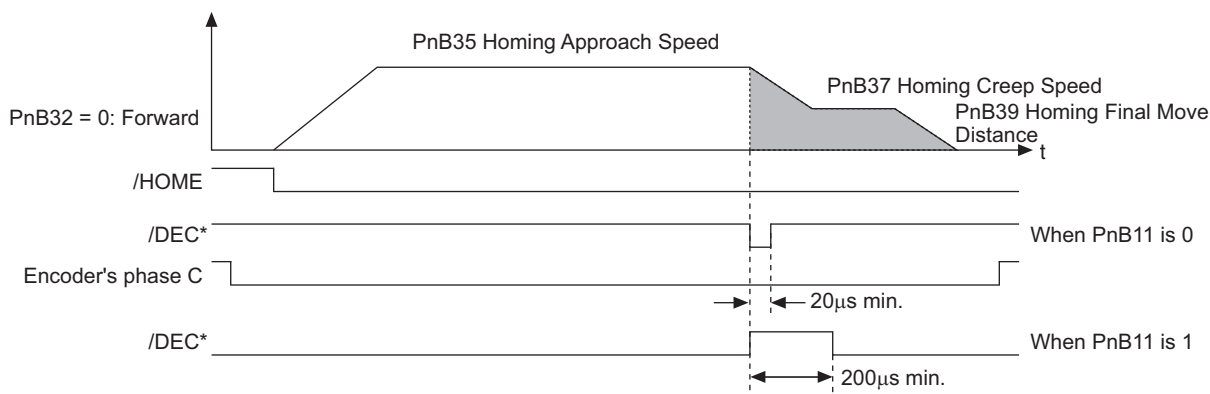

* To change the polarity, use parameter PnB11.

■ Only phase C of the encoder is used for homing (PnB31 = 3).

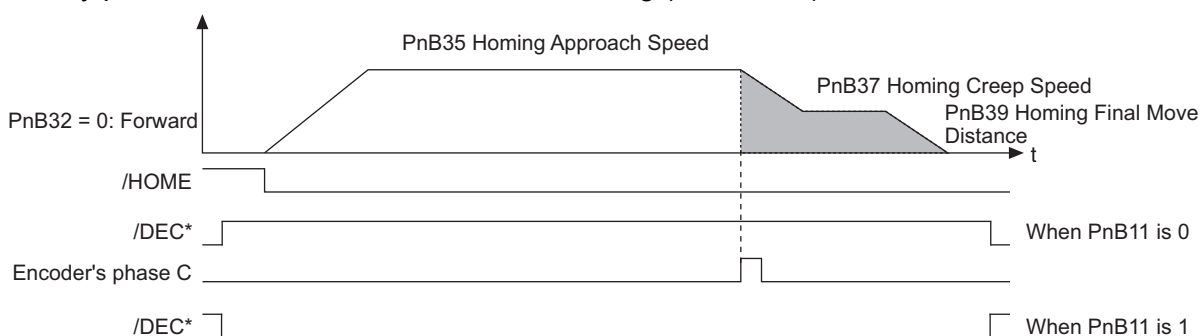

* To change the polarity, use parameter PnB11.

6.6 JOG Speed Table Operation

The /JOGP signal executes forward operation and the /JOGN signal executes reverse operation.

The /JOG0 to /JOG3 signals select the speed.

6.6.1 Example of JOG Speed Table Operation

The following diagram shows an example of JOG Speed Table operation.

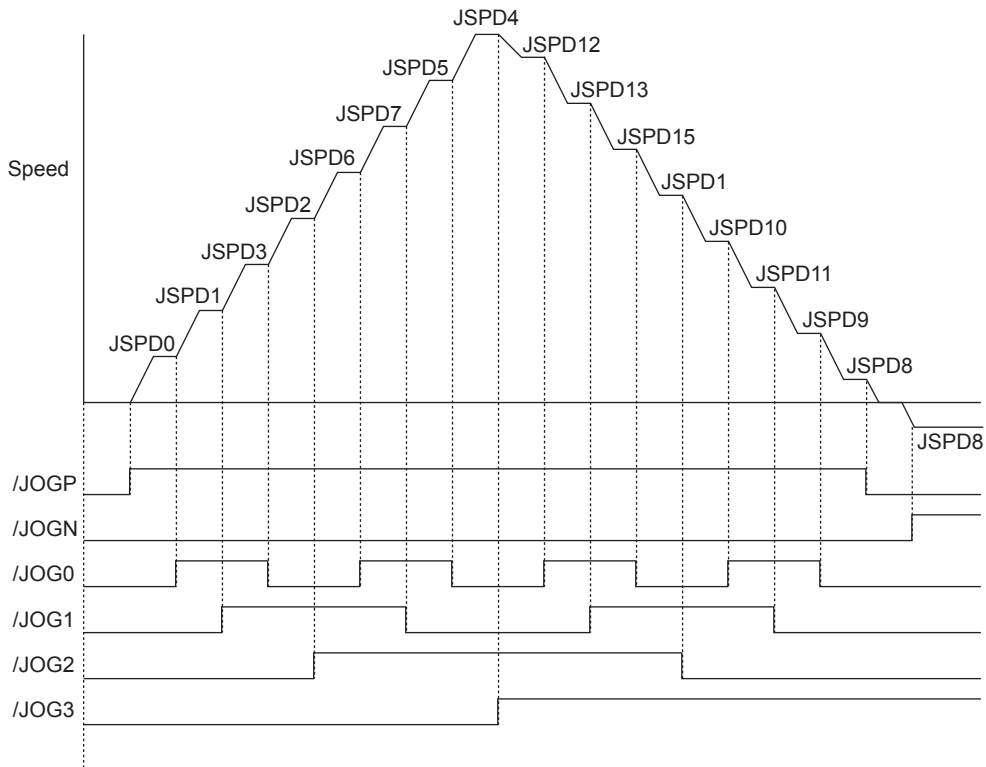

JOG Speed Table Operation

6.6.2 JOG Speed Table

A total of 16 speeds can be set for JSPD0 to JSPD15.

If the edited JOG speed table is saved to flash memory, it will be saved even after the control power supply is turned OFF. Use one of the following methods to save the JOG speed table to flash memory.

- Execute the JSPDSTORE serial command
 - Select “Save JOG Speed Table” from SigmaWin+
 - Use the FnB05 utility function* to save JOG speed tables
- *The function FnB05 is available for the following software versions.
 INDEXER module: Version 3 or later
 SERVOPACK: Version 001B or later

JSPD	JOG Speed	Selection Signals			
		/JOG3	/JOG2	/JOG1	/JOG0
0	nnnnnnnn	---	---	---	---
1	nnnnnnnn	---	---	---	Active
2	nnnnnnnn	---	---	Active	---
3	nnnnnnnn	---	---	Active	Active
4	nnnnnnnn	---	Active	---	---
5	nnnnnnnn	---	Active	---	Active
6	nnnnnnnn	---	Active	Active	---
7	nnnnnnnn	---	Active	Active	Active
8	nnnnnnnn	Active	---	---	---
9	nnnnnnnn	Active	---	---	Active
10	nnnnnnnn	Active	---	Active	---
11	nnnnnnnn	Active	---	Active	Active
12	nnnnnnnn	Active	Active	---	---
13	nnnnnnnn	Active	Active	---	Active
14	nnnnnnnn	Active	Active	Active	---
15	nnnnnnnn	Active	Active	Active	Active

- Note 1. The “---” symbols indicate an inactive signal status.
 2. JSPD: JOG speed number
 /JOG0 to /JOG3: Selection signals
 JOG speed: Speed setting
 Setting range: 1 to 99999999 (1000 Reference units/min)
 Factory setting: 1000

6.6.3 Input Conditions for Homing and JOG Speed Table Operation

The following table shows the functions of the signals related to homing and JOG speed table operation.

/HOME	/JOGP	/JOGN	Operation
Inactive → Active	Inactive	Inactive	Start or restart homing
Inactive	Inactive → Active	Inactive	Forward JOG operation
Inactive	Inactive	Inactive → Active	Reverse JOG operation
Inactive	Inactive	Inactive	Stop
Inactive	Active	Active	Stop
Active	Inactive	Active	Stop
Active	Active	Inactive	Stop
Active	Active	Active	Stop

6.6.4 Input Signal Timing Specifications for Homing and JOG Speed Table Operation

The following figures show the timing specifications of input signals for homing and JOG speed table operation.

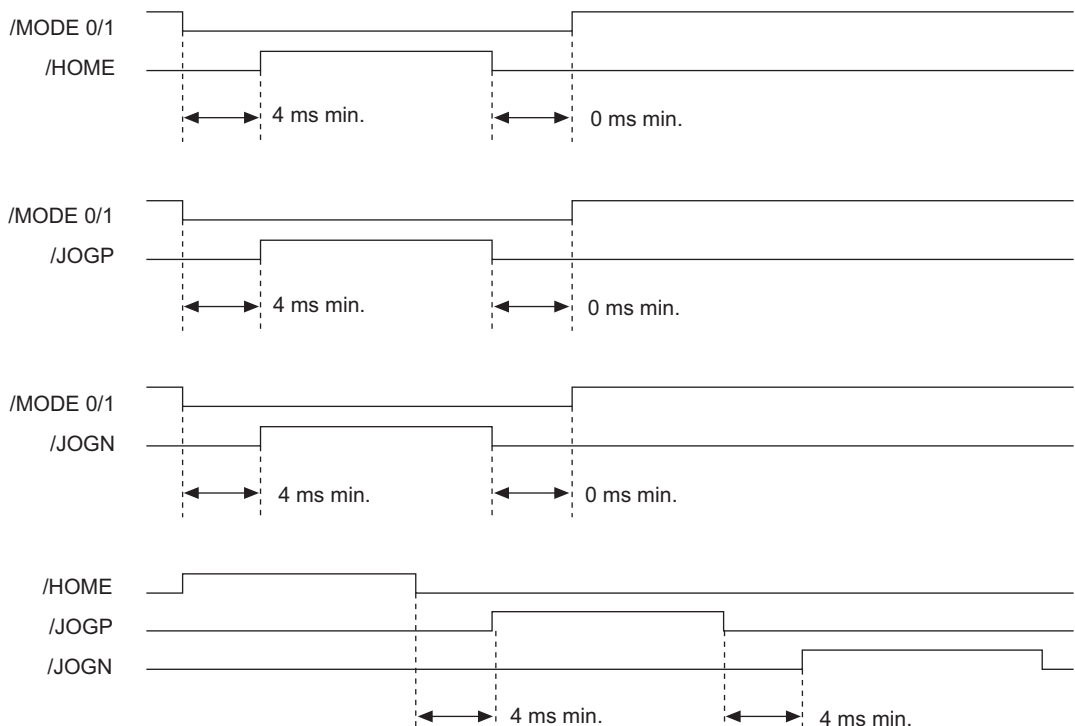

Serial Command Communications

This chapter describes the INDEXER Module's serial command communications.

7.1 CN12 Connector Specifications	7-2
7.2 Settings	7-3
7.2.1 Block Diagram	7-3
7.2.2 Setting the Axis Address	7-3
7.2.3 Parameters Related to Serial Communications	7-3
7.3 Command/Response Format	7-4
7.4 Global Commands	7-5
7.5 Echoback Response Time	7-6
7.6 Response Data Details	7-7
7.6.1 Positive Responses	7-7
7.6.2 Negative Responses	7-7
7.7 Serial Commands	7-8
7.7.1 Basic Operation Commands	7-8
7.7.2 Control Commands	7-9
7.7.3 Parameter Edit Commands	7-22
7.7.4 Program Table Setup Commands	7-24
7.7.5 Program Table Operation Commands	7-28
7.7.6 Zone Table Setup Commands	7-29
7.7.7 JOG Speed Table Setup Commands	7-30
7.7.8 Monitor and Utility Function Commands	7-31

7.1 CN12 Connector Specifications

The following table shows the specifications of the CN12 connector.

Item	Specifications
Interface	Full duplex (RS-422 or RS-485) or half duplex (RS-485) (Set the appropriate wiring method with parameter PnB00.)
Synchronization	Start-stop synchronization (ASYNC)
Bit Rate	9600, 19200, or 38400 bps (Selectable with parameter PnB01.)
Start Bits	1 bit
Data Bits	7 bits, ASCII code
Parity Bits	1 bit, even parity
Stop Bits	1 bit
X-ON/X-OFF Control	No
DTR/DSR Control	No
RTS/CTS Control	No
Echoback	Each character, Each command, or None (Selectable with parameter PnB00.)

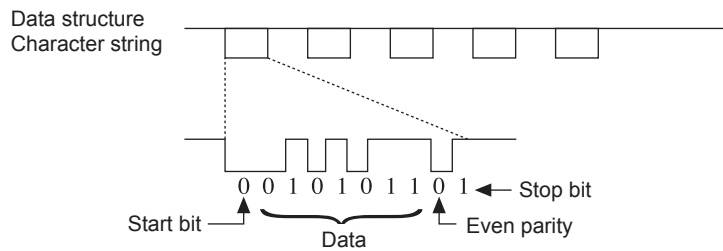

7.2 Settings

This section explains the settings for the INDEXER Module's serial commands.

7.2.1 Block Diagram

The following block diagram shows the basic connections for multi-axis control.

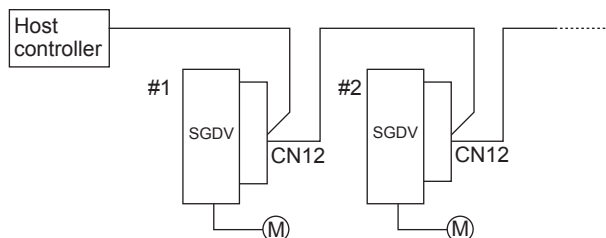

Up to 16 axes can be connected.

For details on wiring, refer to 4.3 *Serial Command Communications Connector (CN12)*.

7.2.2 Setting the Axis Address

Axis addresses can be set with parameter Pn010 (axis address selection). Set an axis address in the range 1 to F. If an address outside this range is set, serial command communications will not be performed. For details on the parameter setting method, refer to *Σ-V Series User's Manual Design and Maintenance Rotational Motor/Command Option Attachable Type (SIEP S800000 60)*.

Note: With the INDEXER Module (NS600) for SGDH SERVOPACKs, axis addresses were set with rotary switches, but with INDEXER Modules (SGDV-OCA03A) for SGDV SERVOPACKs, axis addresses are set in the parameters.

7.2.3 Parameters Related to Serial Communications

The following table shows the parameters that set the communications protocol, bit rate, and “OK” response.

Parameter	Meaning	When Enabled	
PnB00	0	Full-duplex wiring is used for communications method.	After restart
	1 [Factory setting]	Full-duplex wiring is used for communications method. Echoback is performed for each character.	
	2	Half-duplex wiring is used for communications method. CR is used as the delimiter.	
	3	Half-duplex wiring is used for communications method. CR is used as the delimiter. Echoback is performed for each character.	
	4	Half-duplex wiring is used for communications method. CR is used as the delimiter. Echoback is performed for each command.	
	5	Half-duplex wiring is used for communications method. CRLF is used as the delimiter.	
	6	Half-duplex wiring is used for communications method. CRLF is used as the delimiter. Echoback is performed for each character.	
	7	Half-duplex wiring is used for communications method. CRLF is used as the delimiter. Echoback is performed for each command.	
	8, 9	Reserved parameter	
PnB01	0 [Factory setting]	Sets bit rate at 9600 bps.	After restart
	1	Sets bit rate at 19200 bps.	
	2	Sets bit rate at 38400 bps.	
PnB02	0	Does not return OK response.	Immediately
	1 [Factory setting]	Returns OK response.	

7.3 Command/Response Format

The following diagram shows the command/response format.

Command (Host controller → INDEXER Module)			Response (Host controller ← INDEXER Module)		
Axis no.	Command character string	Delimiter	Axis no.	Response character string	Delimiter
	Example: 1SVON	[CR]	Example: 1OK	[CR] [LF]	
	2SVON	[CR]	2OK	[CR] [LF]	
	1POS10000	[CR]	1OK	[CR] [LF]	
	2POS10000	[CR]	2OK	[CR] [LF]	
	1ST	[CR]	1OK	[CR] [LF]	
	2ST	[CR]	2OK	[CR] [LF]	
	1PUN	[CR]	1PUN = +00004567	[CR] [LF]	
	2PUN	[CR]	2PUN = -00002345	[CR] [LF]	

Note: When full-duplex wiring is being used, either [CR] or [CR] [LF] can be used as the delimiter. When half-duplex wiring is being used, set the delimiter to either [CR] or [CR] [LF] with parameter PnB00. In both cases, [CR] [LF] will be returned as the echoback. Upper-case and lower-case characters can be used in the command (including the axis number) and are treated the same.

Note: The response's delimiter is always [CR] [LF]. Alphabetical characters in the response are always upper-case.

Note: In ASCII, the [CR] character is 0D Hex and the [LF] character is 0A Hex.

 <p>IMPORTANT</p>	<p>To maximize communications reliability, confirm the echoback and responses to each command while communicating with the INDEXER Module. When the echoback and responses are not being confirmed, improve the communications reliability by reading the status when appropriate.</p>
---	--

7.4 Global Commands

Global commands are commands that are sent to all axes at the same time.

Command (Host controller → INDEXER Module)			Response (Host controller ← INDEXER Module)
“*”	Command character string	Delimiter	No response returned.
Example: *SVON [CR] *ST [CR] *PUN [CR]			
The axis number setting “*” is the global address and addresses all axes. No echoback or response is returned when the global address is used.			



IMPORTANT

When global commands are used, improve the communications reliability by reading the status when appropriate.

7.5 Echoback Response Time

The following diagram shows the response time from the command transmission until the echoback.

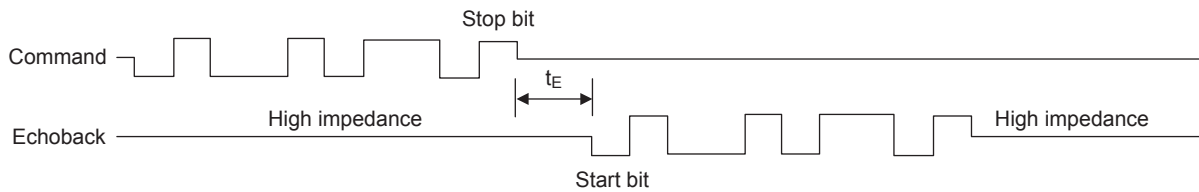

PnB00 (Protocol) Settings	t_E Min.	t_E Max.
1: Full-duplex wiring is used for communications method. Echoback is performed for each character.	$-\frac{1}{\text{Bit rate} \times 2}$ (Centered at the command stop bit)	$100 \mu\text{s} + \frac{1}{\text{Bit rate} \times 2}$
3: Half-duplex wiring is used for communications method. CR is used as the delimiter. Echoback is performed for each character.	$250 \mu\text{s} - \frac{1}{\text{Bit rate} \times 2}$	$600 \mu\text{s} + \frac{1}{\text{Bit rate} \times 2}$
4: Half-duplex wiring is used for communications method. CR is used as the delimiter. Echoback is performed for each command.		
6: Half-duplex wiring is used for communications method. CRLF is used as the delimiter. Echoback is performed for each character.		
7: Half-duplex wiring is used for communications method. CRLF is used as the delimiter. Echoback is performed for each command.		

<Example>

- Echoback response time when PnB00 = 1 (9600 bps):

$$t_E \text{ min.} = -\frac{1}{\text{Bit rate} \times 2} = -\frac{1}{9600 \times 2} = -52 \mu\text{s}$$



IMPORTANT

When using half-duplex wiring, the host controller must set the line driver to high impedance within the t_E min. response time.

7.6 Response Data Details

There are positive responses and negative responses.

The positive response indicates normal operation and the negative response indicates an error.

7.6.1 Positive Responses

There two kinds of positive responses, responses that return data (for commands such as PRM) and responses that do not return data (for commands such as SVON).

For commands that require data to be returned, refer to the description of the individual command for details on the structure of the response's character string.

For commands that do not require data to be returned, the positive response is "OK" unless parameter PnB02 is set to 0. If PnB02 = 0, there is no response.

■ Structure of the Response "OK"

OK [SP] [SP] [SP] [SP] [SP] [SP] [SP] [SP] [CR] [LF]

Note: In ASCII, the [SP] character is 20 Hex, the [CR] character is 0D Hex, and the [LF] character is 0A Hex.

7.6.2 Negative Responses

There will be no response if one of the following errors is detected: a parity error (E48E), framing error (E49E), or overrun error (E4AE). There will be no response to a global command or a command with an incorrect axis number.

In all other cases, a negative response will be returned if an error is detected.

■ Structure of the Negative Response

Undefined Command Error	E56E [SP] ERR [SP] SN [CR] [LF]
Address Out-of-range Error	E57E [SP] ERR [SP] PN [CR] [LF]
Data Out-of-range Error	E58E [SP] ERR [SP] OV [CR] [LF]
Other Errors	ExxE [SP] [SP] [SP] [SP] [SP] [SP] [SP] [CR] [LF] The xx is the error number.

Note: In ASCII, the [SP] character is 20 Hex, the [CR] character is 0D Hex, and the [LF] character is 0A Hex.

7.7 Serial Commands

The axis number and delimiter are attached to actual serial commands, but are omitted here.

Some data in responses (such as parameters, table numbers, and monitored data) is expressed numerically. The presence/absence of the sign and the number of digits are correct in the numerical data shown in these examples, but the sign and numerical value will vary in actual applications.

7.7.1 Basic Operation Commands

The following table shows the basic operation commands.

Basic Operation Commands

Serial Command	Function/Description	Positive Response (Normal Response)
SVON	Servo ON Supplies power to the motor. This command is the same as turning ON the /S-ON signal.	OK
SVOFF	Servo OFF Stops the power supply to the motor. This command is the same as turning OFF the /S-ON signal.	OK
ARES	Alarm Reset Clears the alarm.	The response "OK" will be returned when the alarm has been cleared. The alarm code will be returned if the alarm remains uncleared. ALM [SP] A. xxx [SP] [CR] [LF] (The xxx is the SGD V alarm code.) ALM [SP] E xxA [SP] [CR] [LF] (The xx is the INDEXER Module alarm code.)
RES *	Reset This command is the same as turning OFF/ON the control power supply.	None (No response) Note: If the RES command has been successfully executed, no response will be returned. Because the execution of the RES command resets all status in the same way that restarting the control power supply will, serial communications will be unstable for a maximum of 5 seconds after the RES command is used. Wait at least 5 seconds before sending the next command.

* RES command is available for firmware version 3 or later.

7.7.2 Control Commands

The following table shows the control commands.

Control Commands

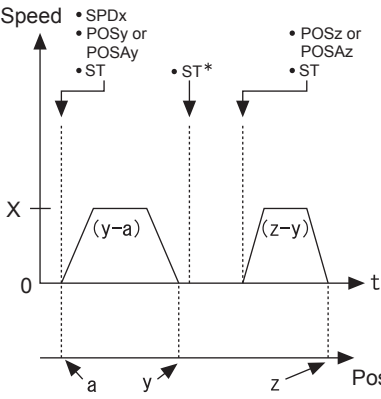
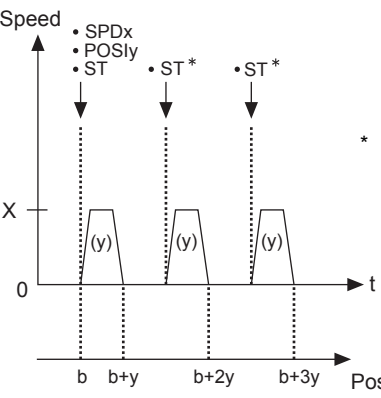
Serial Command	Function/Description	Positive Response
<p>POS (\pm) nnnnnnnn POSA (\pm) nnnnnnnn (The + sign can be omitted.)</p>	<p>Target Position Specification (Absolute Position)</p> <p>Setting range: $-99999999 \leq \text{nnnnnnnn} \leq +99999999$ [Reference units] Specifies the target position as an absolute position.</p>  <p>Note: If a new target position is specified during positioning, the new target position will be used in the next ST command.</p>	OK
<p>POSI (\pm) nnnnnnnn (The + sign can be omitted.)</p>	<p>Target Position Specification (Relative Distance)</p> <p>Setting range: $-99999999 \leq \text{nnnnnnnn} \leq +99999999$ [Reference units] Specifies the target position as a relative distance.</p>  <p>Note: If a new target position is specified during positioning, the new target position will be used in the next ST command.</p>	OK
<p>SPDnnnnnnnn</p>	<p>Positioning Speed Specification</p> <p>Setting range: $1 \leq \text{nnnnnnnn} \leq +99999999$ [1000 reference units/min] Specifies the positioning speed. After the control power supply is turned ON, the positioning speed set in parameter PnB27 will be used until the SPD command is executed.</p> <p>For example, when the reference unit is 0.01 mm and the desired speed is 15 m/min: $15 \text{ m/min} = 15000 \text{ mm/min}$ $= 15000 \times 100 \text{ reference unit/min}$ $= 1500 \text{ [1000 reference unit/min]}$ SPD1500</p> <p>Note: If a new positioning speed is specified during positioning, the new speed will become effective from the next positioning.</p>	OK

Control Commands (cont'd)

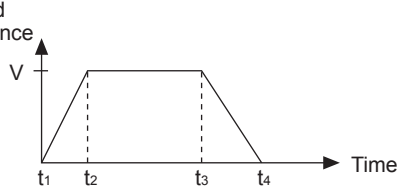
Serial Command	Function/Description	Positive Response
ACCnnnnnnnn	<p>Acceleration Specification</p> <p>Setting range: $1 \leq \text{nnnnnnnn} \leq +99999999$ [1000 (reference units/min)/ms]</p>  $\text{Acceleration} = \frac{V [\times 1000 \text{ reference units/min}]}{t_2 - t_1 [\text{ms}]}$ $\text{Deceleration} = \frac{V [\times 1000 \text{ reference units/min}]}{t_4 - t_3 [\text{ms}]}$ <p>Note: The acceleration setting in parameter PnB29 can also be used. Executing the command ACCnnnnnnnn is the same as executing TRMB29 = nnnnnnnn.</p>	OK
DECnnnnnnnn	<p>Deceleration Specification</p> <p>Setting range: $1 \leq \text{nnnnnnnn} \leq +99999999$ [1000 (reference units/min)/ms]</p> <p>Note: The deceleration setting in parameter PnB2B can also be used. Executing the command DECnnnnnnnn is the same as executing TRMB2B = nnnnnnnn.</p>	OK
ST	<p>Positioning Start</p> <p>Starts positioning with the speed specified by the SPD command and the target position specified by the POS, POSA, or POSI command.</p> <p>The target position specification and speed specification can be omitted. In this case, the previous positioning will be repeated.</p> <p>Error E51E will occur if the ST command is executed but the target position hasn't been specified even once. If the ST command is executed but the speed hasn't been specified even once, the speed specified in parameter PnB27 will be used.</p> <p>When positioning has been stopped with the HOLD command, the positioning will be restarted (the hold will be cleared) if the ST command is executed.</p> <p>Example 1: POSI + nnnnnnnn: Target Position Specification SPDnnnnnnnn: Positioning Speed Specification ST: Positioning Start ST: Repeat</p> <p>Example 2: POSI + nnnnnnnn: Target Position Specification ST: Positioning Start (using the speed specified in PnB27)</p> <p>Example 3: POSI + nnnnnnnn: Target Position Specification ST: Positioning Start HOLD: Positioning Interruption ST: Positioning Restart (Clear Hold)</p> <p>Note: An E53E error will occur if a new move command such as the ST command is received while the motor is already moving (positioning or other moving operation). Execute a move command such as the ST command only after the previous moving operation has been completed.</p>	OK

Control Commands (cont'd)

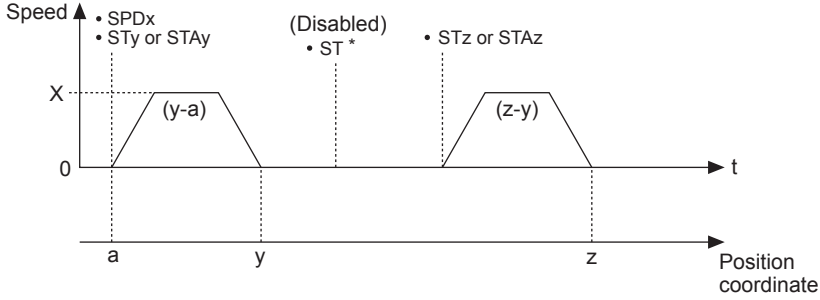
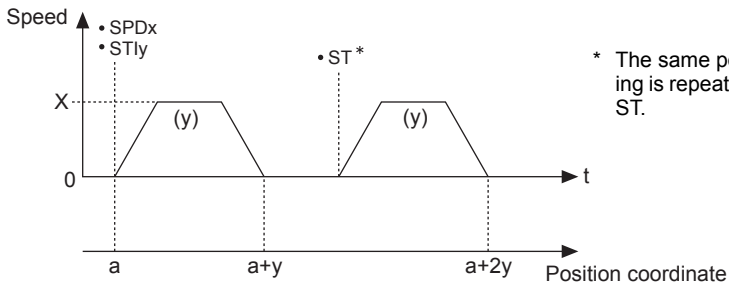
Serial Command	Function/Description	Positive Response
<p>ST (±) nnnnnnnn STA (±) nnnnnnnn (The + sign can be omitted.)</p>	<p>Positioning Start (Absolute Position)</p> <p>Setting range: $-99999999 \leq \text{nnnnnnnn} \leq +99999999$ [Reference units]</p> <p>Specifies the absolute position nnnnnnnn as the target position and starts positioning at the same time. This command is equivalent to the following combination: POSA + nnnnnnnn → ST</p> <p>Example: SPDnnnnnnnn: Positioning Speed Specification STA + nnnnnnnn: Target Position Specification and Positioning Start</p>  <p>* When the target position is an absolute position, the axis will not move if the same positioning is repeated with ST.</p>	<p>OK</p>
<p>STI (±) nnnnnnnn (The + sign can be omitted.)</p>	<p>Positioning Start (Relative Position)</p> <p>Setting range: $-99999999 \leq \text{nnnnnnnn} \leq +99999999$ [Reference units]</p> <p>Specifies the relative distance nnnnnnnn as the target position and starts positioning at the same time. This command is equivalent to the following combination: POSI + nnnnnnnn → ST</p> <p>Example: SPDnnnnnnnn: Positioning Speed Specification STI + nnnnnnnn: Target Position Specification and Positioning Start</p>  <p>* The same positioning is repeated with ST.</p>	<p>OK</p>

Control Commands (cont'd)

Serial Command	Function/Description	Positive Response
RDSTnnnnnnnn	<p>Registration Distance Specification</p> <p>Setting range: $0 \leq \text{nnnnnnnn} \leq 99999999$ [Reference units]</p> <p>Specifies the registration distance that is used in the RS, RSnnnnnnnn, RSAnnnnnnn, and RSInnnnnnn commands.</p> <div data-bbox="651 526 1005 750" style="text-align: center;"> <p>• POSa • RDSTb • SPDx • RSPDy</p> </div> <p>Note: Alarm E23A will occur (the motor will become servo OFF state) if the /RGRT signal latched but the registration distance is longer than the deceleration distance.</p>	OK
RSPDnnnnnnnn	<p>Registration Speed Specification</p> <p>Setting range: $1 \leq \text{nnnnnnnn} \leq 99999999$ [1000 reference units/min]</p> <p>Specifies the registration speed. After the control power supply is turned ON, the registration speed set in parameter PnB27 will be used until the speed is specified with this command.</p> <p>Note: If a new registration speed is specified during registration operation, the new speed will become effective from the next registration operation.</p>	OK

Control Commands (cont'd)

Serial Command	Function/Description	Positive Response
RS	<p>Positioning Start with Registration</p> <p>Starts positioning with the speed specified by the SPD command and the target position specified by the POS, POSA, or POSI command.</p> <p>If the /RGRT signal goes ON during positioning, that position is latched and the motor will move the specified relative distance from the latched position. The registration operation uses the registration distance specified by the RDST command and the registration speed specified by the RSPD command.</p> <p>The target position specification, positioning speed specification, registration distance specification, and registration speed specification can be omitted. In this case, the positioning performed in the previous registration operation will be repeated.</p> <p>Error E51E will occur if the RS command is executed but the target position hasn't been specified even once. Error E52E will occur if the RS command is executed but the registration distance hasn't been specified even once. If the RS command is executed but the positioning speed and registration speed haven't been specified even once, the speed specified in parameter PnB27 will be used either as the positioning speed or the registration speed.</p> <p>When registration positioning has been stopped with the HOLD command, the registration positioning will be restarted (the hold will be cleared) if the RS command is executed.</p> <p>Example 1: POSI + nnnnnnnn: Target Position Specification SPDnnnnnnnn: Positioning Speed Specification RDSTnnnnnnnn: Registration Distance Specification RSPDnnnnnnnn: Registration Speed Specification RS: Positioning Start with Registration RS: Repeat</p> <p>Example 2: POSI + nnnnnnnn: Target Position Specification RDSTnnnnnnnn: Registration Distance Specification RS: Positioning Start with Registration (using the speed specified in PnB27 for both the positioning and registration speeds)</p> <p>Example 3: POSI + nnnnnnnn: Target Position Specification RDSTnnnnnnnn: Registration Distance Specification RS: Positioning Start with Registration HOLD: Positioning Interruption RS: Positioning Restart (Clear Hold)</p> <p>Note: Error E53E will occur if a new move command such as the RS command is received while the motor is already moving (positioning or other moving operation). Execute a move command such as the RS command only after the previous moving operation has been completed.</p>	OK
RS (±) nnnnnnnn RSA (±) nnnnnnnn (The + sign can be omitted.)	<p>Positioning Start with Registration (Absolute Position)</p> <p>Setting range: $-99999999 \leq \text{nnnnnnnn} \leq +99999999$ [Reference units]</p> <p>Specifies the absolute position nnnnnnnn as the target position and starts registration positioning at the same time. This command is equivalent to the following combination: POSA + nnnnnnnn → RS</p> <p>Example: SPDnnnnnnnn: Positioning Speed Specification RDSTnnnnnnnn: Registration Distance Specification RSPDnnnnnnnn: Registration Speed Specification RSA +nnnnnnnn: Target Position Specification and Positioning Start with Registration</p>	OK

Control Commands (cont'd)

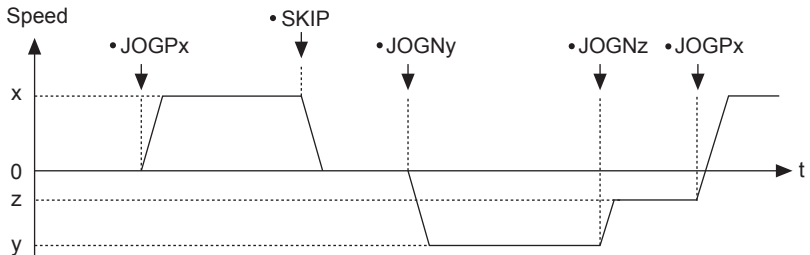
Serial Command	Function/Description	Positive Response
<p>RSI (±) nnnnnnnn (The + sign can be omitted.)</p>	<p>Positioning Start with Registration (Relative Distance)</p> <p>Setting range: -99999999 ≤ nnnnnnnn ≤ +99999999 [Reference units]</p> <p>Specifies the relative distance nnnnnnnn as the target position and starts registration positioning at the same time. This command is equivalent to the following combination: POSI + nnnnnnnn → RS</p> <p>Example: SPDnnnnnnnn: Positioning Speed Specification RDSTnnnnnnnn: Registration Distance RSPDnnnnnnnn: Registration Speed Specification RSI +nnnnnnnn: Target Position Specification and Positioning Start with Registration</p>	<p>OK</p>
<p>JOGPnnnnnnnn JOGNnnnnnnnn</p>	<p>JOG Forward/Reverse</p> <p>Setting range: 1 ≤ nnnnnnnn ≤ 99999999 [1000 reference units/min]</p> <p>Starts JOG forward or JOG reverse operation at the speed specified in nnnnnnnn. JOGPnnnnnnnn: Forward JOGNnnnnnnnn: Reverse</p> <p>The specified speed and JOG direction can be changed while jogging is in progress.</p> 	<p>OK</p>

Control Commands (cont'd)

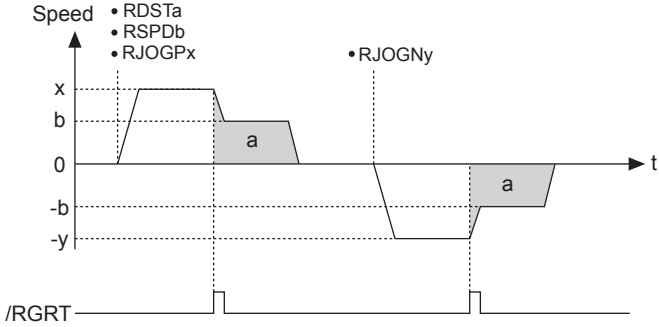
Serial Command	Function/Description	Positive Response
<p>RJOGPnnnnnnnn RJOGNnnnnnnnn</p>	<p>JOG Forward/Reverse with Registration</p> <p>Setting range: $1 \leq \text{nnnnnnnn} \leq 99999999$ [1000 reference units/min]</p> <p>Starts JOG forward or JOG reverse operation at the speed specified in nnnnnnnn. RJOGPnnnnnnnn: Forward RJOGNnnnnnnnn: Reverse</p> <p>If the /RGRT signal goes ON during forward/reverse jogging, that position is latched and the motor will move the specified relative distance from the latched position. The registration operation uses the registration distance specified by the RDST command and the registration speed specified by the RSPD command.</p> <p>Error E52E will occur if the RJOGP/RJOGNnnnnnnnn command is executed but the registration distance hasn't been specified even once. If the RJOGP/RJOGNnnnnnnnn command is executed but the registration speed hasn't been specified even once, the speed specified in parameter PnB27 will be used for the registration speed.</p> <p>When registration jogging has been stopped with the HOLD command, forward registration jogging will be restarted (the hold will be cleared) when the RJOGPnnnnnnnn command is executed again. Reverse registration jogging will be restarted when the RJOGNnnnnnnnn command is executed again.</p> <p>The specified speed and direction cannot be changed while jogging is in progress. Error E53E will occur if the speed or direction is changed during operation.</p> 	<p>OK</p>

Control Commands (cont'd)

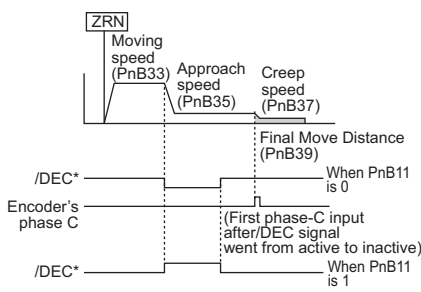
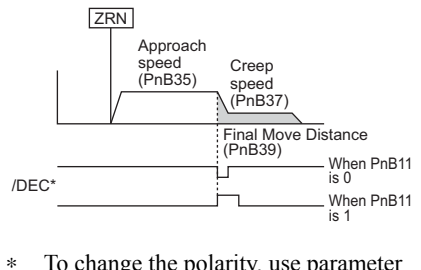
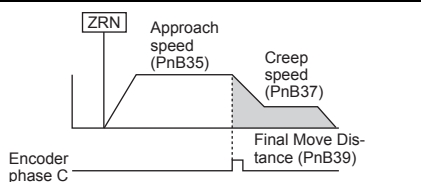
Serial Command	Function/Description	Positive Response							
<p>ZRN</p>	<p>Homing Start</p> <p>Starts homing.</p> <p>When homing has been stopped with the HOLD command, homing will be restarted (the hold will be cleared) when the ZRN command is executed again.</p> <p>The parameters for homing are specified in parameters PnB31 to PnB39.</p>	<p>OK</p>							
	<table border="1" data-bbox="375 577 1252 645"> <thead> <tr> <th data-bbox="375 577 598 645">PnB31 Homing Method</th> <th data-bbox="598 577 821 645">PnB32 Homing Direction</th> <th data-bbox="821 577 1252 645">PnB33 to PnB39</th> </tr> </thead> <tbody> <tr> <td data-bbox="375 645 598 795"> <p>PnB31 = 0: No homing. Homing ends when the control power supply is turned ON.</p> </td> <td data-bbox="598 645 821 795" style="text-align: center;">-</td> <td data-bbox="821 645 1252 795" style="text-align: center;">-</td> </tr> </tbody> </table>		PnB31 Homing Method	PnB32 Homing Direction	PnB33 to PnB39	<p>PnB31 = 0: No homing. Homing ends when the control power supply is turned ON.</p>	-	-	
	PnB31 Homing Method		PnB32 Homing Direction	PnB33 to PnB39					
	<p>PnB31 = 0: No homing. Homing ends when the control power supply is turned ON.</p>		-	-					
<p>PnB31 = 2: Uses the /DEC signal only.</p>	<p>PnB32 = 0: Forward PnB32 = 1: Reverse</p>								
<p>PnB31 = 3: Uses the encoder's phase C only.</p>									
	<p>The current position when homing is completed is specified in PnB25.</p> <p>When the control power supply is turned ON and homing is completed, the value of the current position is replaced with the value in PnB25.</p>								

Control Commands (cont'd)

Serial Command	Function/Description				Positive Response	
ZRN	PnB25	Origin (Incremental Encoder) Absolute Encoder Offset (Absolute Encoder)				OK
		Setting Range	Setting Unit	Factory Setting	When Enabled	
		-99999999 to +99999999	Reference unit	0	After restart	
	Parameter		Meaning		When Enabled	
	PnB31	0 [Factory setting]	Does not execute homing.		After restart	
		1	/DEC and phase C are used for homing.			
		2	Only /DEC is used for homing.			
		3	Only phase C is used for homing.			
	PnB32	0 [Factory setting]	/HOME or ZRN command is used for homing in forward direction.		Immediately	
		1	/HOME or ZRN command is used for homing in reverse direction.			
	PnB33	Homing Moving Speed				
		Setting Range	Setting Unit	Factory Setting	When Enabled	
		1 to 99999999	1000 Reference units/ min	1000	Immediately	
	PnB35	Homing Approach Speed				
		Setting Range	Setting Unit	Factory Setting	When Enabled	
		1 to 99999999	1000 Reference units/ min	1000	Immediately	
	PnB37	Homing Creep Speed				
		Setting Range	Setting Unit	Factory Setting	When Enabled	
		1 to 99999999	1000 Reference units/ min	1000	Immediately	
	PnB39	Homing Final Move Distance				
Setting Range		Setting Unit	Factory Setting	When Enabled		
	-99999999 to +99999999	Reference unit	0	Immediately		
<p>Note: 1. The software limits (PnB21 and PnB23) are disabled until homing is completed. They are enabled after homing is completed. On the other hand, the overtravel signals (P-OT and N-OT signals) are enabled before homing is completed.</p> <p>2. When an incremental encoder is being used, homing will be completed if the ZSET command (coordinates setting) is executed instead of homing.</p> <p>3. Error E5DE will occur if the ZRN command is executed while PnB31 = 0.</p> <p>4. Homing can be performed only when an incremental encoder is being used. Error E61E will occur if the ZRN command is executed and an absolute encoder is being used.</p>						

Control Commands (cont'd)

Serial Command	Function/Description	Positive Response
ZSET (±) nnnnnnnn	<p>Coordinates Setting</p> <p>Note: It can be dangerous to execute this command carelessly to switch the coordinates of the reference position. After executing this command, confirm that the reference position and the new coordinates are in agreement before starting operation.</p> <p>Setting range: $-99999999 \leq \text{nnnnnnnn} \leq +99999999$ [Reference units]</p> <ul style="list-style-type: none"> • With an Incremental Encoder Replaces the current position with nnnnnnnn. Homing will be completed and the software limits (PnB21 and PnB23) will be enabled. This coordinates setting will be cleared when the control power supply is turned OFF. <p>Note: Parameter PnB25 will not be refreshed. PnB25 will be used as the current position when the control power supply is turned ON and homing is completed.</p> <ul style="list-style-type: none"> • With an Absolute Encoder Switches the current position to nnnnnnnn and refreshes PnB25 with the absolute position offset so that the current position becomes nnnnnnnn. The coordinates setting will remain effective after the control power supply is turned OFF. Normally, this command is executed once during system setup and it is not necessary to execute it again. Each time that the command is executed, the content of PnB25 is refreshed and stored in EEPROM, so this command must not be executed repeatedly or too frequently. <p>Note: When one of the Pn20E to Pn210, Pn205, or PnB20 to PnB25 parameters has been changed, enable the new setting by turning the control power supply OFF and then ON again before executing the command.</p>	OK

Control Commands (cont'd)

Serial Command	Function/Description	Positive Response
HOLD	<p>Positioning Interruption</p> <p>Interrupts the current positioning. The remainder of the positioning is put on hold.</p> <p>When the HOLD command has interrupted a positioning initiated by an ST, STnnnnnnnn, STAnnnnnnnn, or STInnnnnnnn command, the positioning can be restarted by executing the ST command.</p> <p>When the HOLD command has interrupted registration positioning initiated by an RS, RSnnnnnnnn, RSAnnnnnnnn, or RSInnnnnnnn command, the registration positioning can be restarted by executing the RS command.</p> <p>When the HOLD command has interrupted a “forward jogging with registration” operation that was initiated by the RJOGPnnnnnnnn command, the operation can be restarted by executing the RJOGPnnnnnnnn command again.</p> <p>When the HOLD command has interrupted a “reverse jogging with registration” operation that was initiated by the RJOGNnnnnnnnn command, the operation can be restarted by executing the RJOGNnnnnnnnn command again.</p> <p>When the HOLD command has interrupted a homing initiated by the ZRN command, homing can be restarted by executing the ZRN command.</p> <p>When the HOLD command is executed during a JOG forward operation initiated by JOGPnnnnnnnn or a JOG reverse operation initiated by JOGNnnnnnnnn, the JOG operation will be stopped.</p> <p>When the HOLD command is executed after positioning is completed, a remaining distance of zero is put on hold.</p> <p>If a new target position is specified while a positioning has been put on hold by the HOLD command, the remaining distance is canceled and the new target position is used instead.</p>	OK

Control Commands (cont'd)

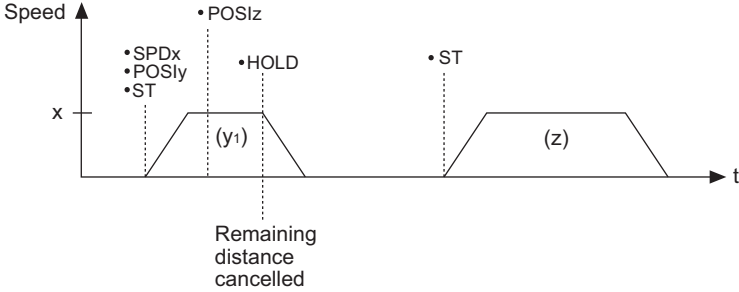
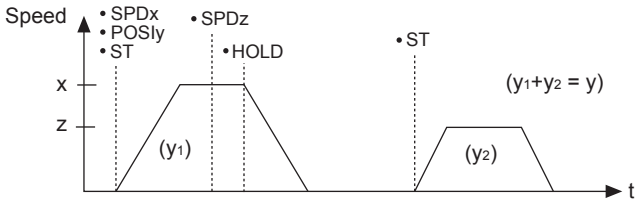
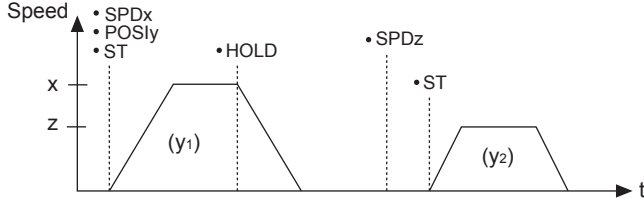
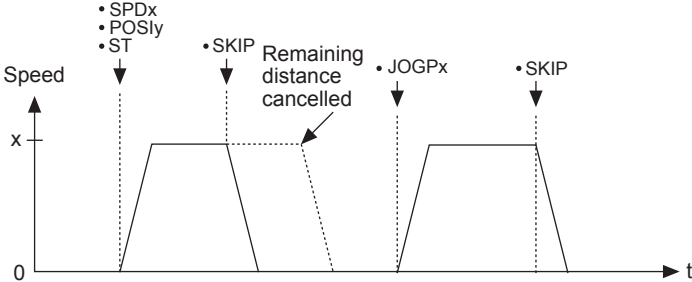
Serial Command	Function/Description	Positive Response
HOLD	<p>Even if a new target position is specified before the HOLD command is executed, the remaining distance will be canceled and the new target position will be used instead.</p>  <p>When the speed setting has been changed, the new setting will be used when positioning is restarted.</p> <p>Example 1:</p>  <p>Example 2:</p> 	OK
SKIP	<p>Positioning Stop</p> <p>Stops the current positioning. The remaining distance will be cancelled.</p> 	OK

Control Commands (cont'd)

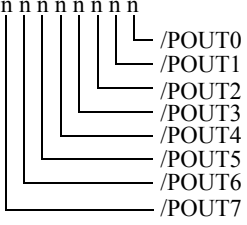
Serial Command	Function/Description	Positive Response
POUTnnnnnnnn	<p>POUT Specification</p> <p>Specifies the operation of programmable output signals /POUT0 to /POUT7.</p> <p>Settings: N: Inactive A: Active Z: Zone table “:”: Continue</p> <p>POUT n n n n n n n n</p> 	OK

7.7.3 Parameter Edit Commands

The following table shows the Parameter Edit Commands.

Parameter Edit Commands

Serial Command	Function/Description	Positive Response
PRMppp	<p>Parameter Read</p> <p>Reads a parameter. ppp: Parameter number (Pn number)</p> <p>Example: Reading PnB00 Command: 1PRMB00 [CR] Response: 1PRMB00 = 00000001 [CR] [LF]</p>	<p>An 8-digit signed decimal value is returned for commands PRM124, PRM164, PRM165, PRM550 to PRM553, PRMB21, PRMB23, PRMB25, PRMB39, and PRMB50. Example: PRMB21 = +12345678 [CR] [LF]</p> <p>An 8-digit hexadecimal value is returned for commands PRM000 to PRM002, PRM006 to PRM009, PRM00B to PRM00D, PRM010, PRM10B, PRM139, PRM140, PRM160, RPM170, PRM310, PRM408, PRM460, PRM530, PRM587, PRMB53. Example: PRM000 = 00001234 [CR] [LF]</p> <p>A 10-digit unsigned decimal value is returned for commands PRM20E, PRM210, PRM212, PRM520, PRM526, and PRM531. Example: PRM20E=1234567890 [CR] [LF]</p> <p>An 8-digit unsigned decimal value is returned for all other parameters. Example: PRMB00 = 12345678 [CR] [LF]</p>
PRMppp = (±) nnnnnnnn	<p>Parameter Write</p> <p>Sets a parameter. ppp: Parameter number (Pn number)</p> <p>Parameters are stored in EEPROM, so the settings will be retained after the control power supply is turned OFF. Because the value is stored in EEPROM, this command must not be used if the setting needs to be changed frequently. In such a case, use the TRMppp = (±) nnnnnnnn command.</p> <p>Note: Parameter settings are either enabled immediately or after restarting the power supply. For details, refer to <i>10.1 Parameter List for INDEXER Module</i>.</p>	OK
TRMppp = (±) nnnnnnnn	<p>Temporary Parameter Write</p> <p>Sets a parameter. ppp: Parameter number (Pn number)</p> <p>The PRMppp = (±) nnnnnnnn command stores the parameter setting in EEPROM, but the TRMppp = (±) nnnnnnnn command does not. Because this command does not write the setting in EEPROM, it can be used to change settings frequently.</p> <p>Note: Parameter settings are either enabled immediately or after restarting the power supply. To edit parameters that are enabled after restarting, use the PRMppp = (±) nnnnnnnn command instead of the TRMppp = (±) nnnnnnnn command. For details, refer to <i>10.1 Parameter List for INDEXER Module</i>.</p>	OK

Parameter Edit Commands (cont'd)

Serial Command	Function/Description	Positive Response
PRMINIT	Parameter Initialization Resets all parameters to their factory settings. After executing PRMINIT, turn the control power supply OFF and ON.	OK

7.7.4 Program Table Setup Commands

The following table shows the Program Table Setup Commands.

Program Table Setup Commands

Serial Command	Function/Description	Positive Response
PGMSTORE	<p>Program Table Save</p> <p>Saves the program table in flash memory. Once PGMSTORE is executed, the program table will be retained after the control power supply is turned OFF. Because the program table is stored in flash memory, this command must not be executed frequently.</p> <p>Note: Do not turn OFF the control power supply while PGMSTORE is being executed. Execution can take a few seconds to slightly longer than 10 seconds. The green LED will flash during execution.</p>	OK
PGMINIT	<p>Program Table Initialization</p> <p>Resets all values in the program table to their factory settings.</p> <p>Note: Do not turn OFF the control power supply while PGMINIT is being executed. Execution can take a few seconds to slightly longer than 10 seconds. The green LED will flash during execution.</p>	OK
POST _{sss}	<p>Program Table POS Read</p> <p>Reads the POS value (positioning target position). sss: Program step (PGMSTEP)</p>	POST123 = A+12345678 [CR] [LF] POST123 = I+12345678 [CR] [LF] POST123 = S+12345678 [CR] [LF] POST123 = +INFINITE [SP] [CR] [LF] POST123 = STOP [SP] [SP] [SP] [SP] [SP] [SP] [CR] [LF] POST123 = -[SP] [SP] [SP] [SP] [SP] [SP] [SP] [SP] [SP] [CR] [LF]
POST _{sss} = nnnnnnnn	<p>Program Table POS Write</p> <p>Sets the POS value (positioning target position). sss: Program step (PGMSTEP)</p> <p>Settings: Annnnnnnn: Absolute position [Reference units] (−99999999 ≤ nnnnnnnn ≤ +99999999) Innnnnnnn: Relative distance [Reference units] (−99999999 ≤ nnnnnnnn ≤ +99999999) Snnnnnnnn: Continuous stop [Reference units] (−99999999 ≤ nnnnnnnn ≤ +99999999) +INFINITE or -INFINITE: JOG forward or JOG reverse STOP: Stop −: No specification</p>	OK
SPDT _{sss}	<p>Program Table SPD Read</p> <p>Reads the SPD value (positioning speed). sss: Program step (PGMSTEP)</p>	SPDT123 = 12345678 [CR] [LF]
SPDT _{sss} = nnnnnnnn	<p>Program Table SPD Write</p> <p>Sets the SPD value (positioning speed). sss: Program step (PGMSTEP)</p> <p>Settings: 1 ≤ nnnnnnnn ≤ +99999999 [1000 reference units/min]</p>	OK

Program Table Setup Commands (cont'd)

Serial Command	Function/Description	Positive Response
RDSTTsss	Program Table RDST Read Reads the RDST value (registration distance). sss: Program step (PGMSTEP)	RDSTT123 = 12345678 [CR] [LF] RDSTT123 = -[SP] [SP] [SP] [SP] [SP] [SP] [SP] [CR] [LF]
RDSTTsss = nnnnnnnn	Program Table RDST Write Sets the RDST value (registration distance). sss: Program step (PGMSTEP) Settings: 0 ≤ nnnnnnnn ≤ 99999999: Registration distance [Reference units] -: No registration	OK
RSPDTsss	Program Table RSPD Read Reads the RSPD value (registration speed). sss: Program step (PGMSTEP)	RSPDT123 = 12345678 [CR] [LF]
RSPDTsss = nnnnnnnn	Program Table RSPD Write Sets the RSPD value (registration speed). sss: Program step (PGMSTEP) Settings: 1 ≤ nnnnnnnn ≤ +99999999 [1000 reference units/min]	OK
ACCTsss	Program Table ACC Read Reads the ACC value (acceleration). sss: Program step (PGMSTEP)	ACCTsss = 12345678 [CR] [LF] ACCTsss = :[SP] [SP] [SP] [SP] [SP] [SP] [SP] [CR] [LF]
ACCTsss = nnnnnnnn	Program Table ACC Write Sets the ACC value (acceleration). sss: Program step (PGMSTEP) Settings: 1 ≤ nnnnnnnn ≤ +99999999: Acceleration [1000 (reference units/min)/ms] “.”: Continues the previously executed program step’s specification.	OK
DECTsss	Program Table DEC Read Reads the DEC value (deceleration). sss: Program step (PGMSTEP)	DECTsss = 12345678 [CR] [LF] DECTsss = :[SP] [SP] [SP] [SP] [SP] [SP] [SP] [CR] [LF]
DECTsss = nnnnnnnn	Program Table DEC Write Sets the DEC value (deceleration). sss: Program step (PGMSTEP) Settings: 1 ≤ nnnnnnnn ≤ +99999999: Deceleration [1000 (reference units/min)/ms] “.”: Continues the previously executed program step’s specification.	OK
POUTTsss	Program Table POUT Read Reads the POUT value (programmable output signal). sss: Program step (PGMSTEP)	POUTT123 = NANANANZ [CR] [LF]

Program Table Setup Commands (cont'd)

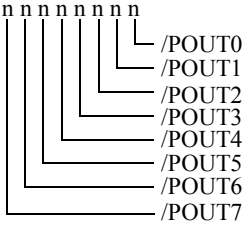
Serial Command	Function/Description	Positive Response
POUTTsss = nnnnnnnn	<p>Program Table POUT Write</p> <p>Sets the POUT value (programmable output signal). sss: Program step (PGMSTEP)</p> <p>Settings: N: Inactive A: Active Z: Zone table “:”: Continues the previously executed program step’s specification.</p> <p>POUT n n n n n n n n</p> 	OK
EVENTTsss	<p>Program Table EVENT Read</p> <p>Reads the EVENT value (pass condition). sss: Program step (PGMSTEP)</p>	EVENTT123 = T12345 [SP] [SP] [SP] [SP] [CR] [LF] EVENTT123 = IT12345 [SP] [SP] [SP] [CR] [LF] EVENTT123 = NT12345 [SP] [SP] [SP] [CR] [LF] EVENTT123 = DT12345 [SP] [SP] [SP] [CR] [LF] EVENTT123 = SELIT12345 [CR] [LF] EVENTT123 =:[SP] [SP] [SP] [SP] [SP] [SP] [SP] [SP] [SP] [CR] [LF]
EVENTTsss = nnnnnnnn	<p>Program Table EVENT Write</p> <p>Sets the EVENT value (pass condition). sss: Program step (PGMSTEP)</p> <p>Settings: I: INPOSITION (positioning completed) active N: NEAR (near position) active D: DEN (positioning reference distribution completed) active SELx: SEL input signal active (x = 0 to 7) Tnnnnn: Time elapsed (ms) since the program step started. (0 ≤ nnnnn ≤ 99999) ITnnnnn: Time elapsed (ms) after the INPOSITION signal became active. (0 ≤ nnnnn ≤ 99999) NTnnnnn: Time elapsed (ms) after the NEAR signal became active. (0 ≤ nnnnn ≤ 99999) DTnnnnn: Time elapsed (ms) after the DEN signal became active. (0 ≤ nnnnn ≤ 99999) SELxnnnnn: Time elapsed (ms) after the SEL input signal became active. (x = 0 to 7, 0 ≤ nnnnn ≤ 99999) “:”: Continues the previously executed program step’s specification.</p>	OK
LOOPtsss	<p>Program Table LOOP Read</p> <p>Reads the LOOP value (number of repetitions). sss: Program step (PGMSTEP)</p>	LOOPt123 = 12345 [CR] [LF]

Program Table Setup Commands (cont'd)

Serial Command	Function/Description	Positive Response
LOOPtsss = nnnnn	Program Table LOOP Write Sets the LOOP value (number of repetitions). sss: Program step (PGMSTEP) Setting: $1 \leq \text{nnnnn} \leq 99999$	OK
NEXTTsss	Program Table NEXT Read Reads the NEXT value (link destination). sss: Program step (PGMSTEP)	NEXTT123 = 12345 [CR] [LF] NEXTT123 = END [SP] [SP] [CR] [LF]
NEXTTsss = nnn	Program Table NEXT Write Sets the NEXT value (link destination). sss: Program step (PGMSTEP) Settings: $0 \leq \text{nnn} \leq 255$: Program step (PGMSTEP) END: End	OK

7.7.5 Program Table Operation Commands

The following table shows the Program Table Operation Commands.

Program Table Operation Commands

Serial Command	Function/Description	Positive Response
STARTsss	<p>Program Table Operation Start</p> <p>Starts program table operation from program step sss. sss: Program step (PGMSTEP)</p> <p>When program table operation has been interrupted by the STOP command or other method, the STARTsss command can be executed to cancel that operation and simultaneously start a new program table operation from program step sss.</p>	OK
START	<p>Program Table Operation Restart</p> <p>When program table operation has been interrupted by the STOP command or other method, the START command can be executed to restart that operation (clearing the hold state). If program table operation was canceled or ended, the START command will start a new program table operation from the program step (sss) that was specified in the last STARTsss command.</p>	OK
STOP	<p>Program Table Operation Interruption</p> <p>Interrupts a program table operation. When a positioning is in progress, the remainder of the operation (remaining distance) is put on hold.</p>	OK
PGMRES	<p>Program Table Operation Reset</p> <p>When program table operation has been interrupted by the STOP command or other method, the PGMRES command can be executed to cancel that operation (reset program table operation.)</p>	OK

7.7.6 Zone Table Setup Commands

The following table shows the Zone Table Setup Commands.

Zone Table Setup Commands

Serial Command	Function/Description	Positive Response
ZONESTORE	Zone Table Save Saves the zone table in flash memory. Once ZONESTORE is executed, the zone table will be retained after the control power supply is turned OFF. Because the zone table is stored in flash memory, this command must not be executed frequently.	OK
ZONEINIT	Zone Table Initialization Resets all values in the zone table to their factory settings.	OK
ZONEPTzz	Zone Table ZONEP Read Reads the ZONEP value (positive side zone boundary position.) zz: Zone number (ZONE ID)	ZONEPT123 = +12345678 [CR] [LF]
ZONEPTzz = nnnnnnnn	Zone Table ZONEP Write Sets the ZONEP value (positive side zone boundary position). zz: Zone number (ZONE ID) Settings: $-99999999 \leq \text{nnnnnnnn} \leq +99999999$	OK
ZONENTzz	Zone Table ZONEN Read Reads the ZONEN value (negative side zone boundary position.) zz: Zone number (ZONE ID)	ZONENT123 = +12345678 [CR] [LF]
ZONENTzz = nnnnnnnn	Zone Table ZONEN Write Sets the ZONEN value (negative side zone boundary position). zz: Zone number (ZONE ID) Settings: $-99999999 \leq \text{nnnnnnnn} \leq +99999999$	OK

7.7.7 JOG Speed Table Setup Commands

The following table shows the JOG Speed Table Setup Commands.

JOG Speed Table Setup Commands

Serial Command	Function/Description	Positive Response
JSPDSTORE	<p>JOG Speed Table Save</p> <p>Saves the JOG speed table in flash memory. Once JSPDSTORE is executed, the jog speed table will be retained after the control power supply is turned OFF. Because the JOG speed table is stored in flash memory, this command must not be executed frequently.</p>	OK
JSPDINIT	<p>JOG Speed Table Initialization</p> <p>Resets all values in the JOG speed table to their factory settings.</p>	OK
JSPDTdd	<p>JOG Speed Table Read</p> <p>Reads the JOG speed table setting for the specified number. dd: JOG speed number</p>	JSPDT123 = 12345678 [CR] [LF]
JSPDTdd = nnnnnnnn	<p>JOG Speed Table Write</p> <p>Sets the JOG speed table setting for the specified number. dd: JOG speed number</p> <p>Settings: $1 \leq \text{nnnnnnnn} \leq 99999999$</p>	OK

7.7.8 Monitor and Utility Function Commands

The following table shows the Monitor and Utility Function Commands.

Monitor and Utility Function Commands

Serial Command	Function/Description	Positive Response
ALM	Alarm or Warning Read	<p>One of the following responses is returned depending on the status.</p> <ul style="list-style-type: none"> • ALM [SP] A.xxx [SP] [CR] [LF] (The “xxx” is the SERVOPACK’s alarm/warning code.) • ALM [SP] ExxA [SP] [CR] [LF] (ExxA is the INDEXER Module’s alarm code.) • ALM [SP] HBB [SP] [CR] [LF] *1 • ALM [SP] P-OT [SP] [CR] [LF] • ALM [SP] N-OT [SP] [CR] [LF] • ALM [SP] P-LS [SP] [CR] [LF] • ALM [SP] N-LS [SP] [CR] [LF] • ALM [SP] BB [SP] [SP] [SP] [CR] [LF] • ALM [SP] HOLD [SP] [CR] [LF] • ALM [SP] INPOS [CR] [LF] • ALM [SP] NEAR [SP] [CR] [LF] • ALM [SP] RUN [SP] [SP] [CR] [LF] • ALM [SP] . [SP] [SP] [SP] [SP] [CR] [LF]
ALMn	Alarm History Read (0 ≤ n ≤ 9)	<p>One of the following responses is returned depending on the status: No alarm, SERVOPACK alarm, or INDEXER Module alarm.</p> <ul style="list-style-type: none"> • ALM1 = NONE [CR] [LF] • ALM1 = A.xxx [CR] [LF] • ALM1 = ExxA [CR] [LF]
ERR	Most Recent Error Read	<p>One of the following responses is returned. A response of “NONE” indicates that no errors have occurred.</p> <ul style="list-style-type: none"> • ERR [SP] NONE [SP] [CR] [LF] • ERR [SP] ExxE [SP] [CR] [LF]
IN1*2	SERVOPACK Input Signal Monitor	<p>IN1 = 01010101 [CR] [LF]</p> <p>0: Photocoupler OFF 1: Photocoupler ON</p> <p>Bit 0: /S-ON Bit 1: /ALM-RST Bit 2: P-OT Bit 3: N-OT Bit 4: /DEC Bit 5: Not used (Invalid) Bit 6: /RGRT Bit 7: Not used (Always 0)</p>

* 1. HBB response is available for firmware version 3 and later.

* 2. To reverse the bit polarities, use parameter PnB53 for firmware version 4 or later.

Monitor and Utility Function Commands (cont'd)

Serial Command	Function/Description	Positive Response
IN2	INDEXER Module Input Signal Monitor	IN2 = 10101010101 [CR] [LF] 0: Photocoupler OFF 1: Photocoupler ON Bit 0: /MODE 0/1 Bit 1: /START-STOP; /HOME Bit 2: /PGMRES; /JOGP Bit 3: /SEL0; /JOGN Bit 4: /SEL1; /JOG0 Bit 5: /SEL2; /JOG1 Bit 6: /SEL3; /JOG2 Bit 7: /SEL4; /JOG3 Bit 8: /SEL5 Bit 9: /SEL6 Bit 10: /SEL7
IN2TESTbbbbbbbbbb	INDEXER Module Input Signal Specification The actual signal is ignored and the input signal is forcibly set to the specified status. This command is used to test operation when the actual signal line is not connected. b = 0: Photocoupler OFF b = 1: Photocoupler ON Bit 0: /MODE 0/1 Bit 1: /START-STOP; /HOME Bit 2: /PGMRES; /JOGP Bit 3: /SEL0; /JOGN Bit 4: /SEL1; /JOG0 Bit 5: /SEL2; /JOG1 Bit 6: /SEL3; /JOG2 Bit 7: /SEL4; /JOG3 Bit 8: /SEL5 Bit 9: /SEL6 Bit 10: /SEL7 IN2TESTEND: Return to actual signal status. Note: 1. Error E56E will occur if fewer than 11 digits (bbbbbbbbbb) are specified in the command. 2. If operation is being performed in Mode 0 (program table operation mode), /MODE0/1 must be set to 1 before /START-STOP is set to 1. If operation is being performed in Mode 1 (homing or JOG speed table operation mode), /MODE0/1 must be set to 0 before /HOME, /JOGP, or /JOGN is set to 1.	OK
IN3 ^{*3}	Safety Input Signal Monitor	IN3 = 01010101 [CR] [LF] 0: Photocoupler OFF 1: Photocoupler ON Bit 0: /HWBB1 Bit 1: /HWBB2 Bit 2 to Bit 7: Not used (indefinite)

* 3. IN3 command is available for firmware version 3 and later.

Monitor and Utility Function Commands (cont'd)

Serial Command	Function/Description	Positive Response
OUT1	SERVOPACK Output Signal Monitor	OUT1 = 01010101 [CR] [LF] 0: Photocoupler OFF 1: Photocoupler ON Bit 0: ALM Bit 1: /WRN Bit 2: /BK Bit 3: /S-RDY Bit 4: ALO1 Bit 5: ALO2 Bit 6: ALO3 Bit 7: Not used (Always 0)
OUT2	INDEXER Module Output Signal Monitor	OUT2 = 101010101 [CR] [LF] 0: Photocoupler OFF 1: Photocoupler ON Bit 0: /INPOSITION Bit 1: /POUT0 Bit 2: /POUT1 Bit 3: /POUT2 Bit 4: /POUT3 Bit 5: /POUT4 Bit 6: /POUT5 Bit 7: /POUT6 Bit 8: /POUT7
OUT2TESTbbbbbbbbb	INDEXER Module Output Signal Specification Forcibly sets the output signals to the specified status. This command is used to check wiring. b = 0: Photocoupler OFF b = 1: Photocoupler ON Bit 0: /INPOSITION Bit 1: /POUT0 Bit 2: /POUT1 Bit 3: /POUT2 Bit 4: /POUT3 Bit 5: /POUT4 Bit 6: /POUT5 Bit 7: /POUT6 Bit 8: /POUT7 OUT2TESTEND: Clears the forced signal status. Note: Error E56E will occur if fewer than 9 digits (bbbbbbbbb) are specified in the command.	OK
POUT	POUT Monitor	POUT [SP] NNNAZZZZ [CR] [LF] Bit 0: /POUT0 Bit 1: /POUT1 Bit 2: /POUT2 Bit 3: /POUT3 Bit 4: /POUT4 Bit 5: /POUT5 Bit 6: /POUT6 Bit 7: /POUT7
PGMSTEP	Program Step (PGMSTEP) Monitor	PGMSTEP = 12345 [CR] [LF]
EVTIME	Program EVENT Elapsed Time Monitor Monitors time elapsed (ms) for the EVENT function in program table operation.	EVTIME = 12345 [CR] [LF]

Monitor and Utility Function Commands (cont'd)

Serial Command	Function/Description	Positive Response
LOOP	Program Table Operation LOOP Pass Through Monitor	LOOP = 12345 [CR] [LF]
MONn	Monitor Read ($1 \leq n \leq 11$) See following description of STS to RDST.	See following description of the responses for STS to RDST.
STS or MON6	Status Flag Monitor	STS = 1010101 [CR] [LF] Bit 0: ON (1) when the /INPOSITION (positioning completed) signal is active. Bit 1: ON (1) when the NEAR (near position) signal is active. Bit 2: ON (1) when the DEN (positioning reference distribution completed) signal is active. Bit 3: ON (1) when positioning or program operation is interrupted (on hold). Bit 4: ON (1) during program operation. Bit 5: ON (1) when the current (torque) is being limited. Bit 6: ON (1) when the main power supply is ON.
PUN or MON1	Current Distributed Position Monitor	PUN = +12345678 [CR] [LF]
PFB or MON7	Current (Actual) Motor Position Monitor	PFB = +12345678 [CR] [LF]
POS or MON8	Target Position Monitor	POS = +12345678 [CR] [LF]
DST or MON9	Target Distance Monitor	DST = +12345678 [CR] [LF]
RPOS or MON10	Registration Target Position Monitor	RPOS = +12345678 [CR] [LF]
RDST or MON11	Registration Target Distance Monitor	RDST = 12345678 [CR] [LF]
NFB or MON3	Motor Speed Monitor [min^{-1}] (rotational motor) Motor Speed Monitor [mm/s] (linear motor)	NFB = +12345678 [CR] [LF]
TREF or MON5	Internal Torque Reference Monitor [%]	TREF = +12345678 [CR] [LF]
NREF or MON4	Speed Reference Monitor [min^{-1}] (rotational motor) Speed Reference Monitor [mm/s] (linear motor)	NREF = +12345678 [CR] [LF]
PER or MON2	Position Error Monitor [Reference units]	PER = +12345678 [CR] [LF]
TRMS	Cumulative Load Ratio Monitor [%]	TRMS = 12345678 [CR] [LF]
RGRMS	Regeneration Load Ratio Monitor [%]	RGRMS = 12345678 [CR] [LF]
DBRMS	Dynamic-Brake Load Ratio Monitor [%]	DBRMS = 12345678 [CR] [LF]
HALLSENS	Hall Sensor Monitor for Linear Motor	HALLSENS = 1 [SP] LLH [CR] [LF] A number \uparrow between 0 and 7 $\uparrow\uparrow\uparrow$ <ul style="list-style-type: none"> \uparrow Status of phase W [H or L] \uparrow Status of phase V [H or L] \uparrow Status of phase U [H or L]
TYPE	INDEXER Module Model Code Display INDEXER Module Model Code = 0A03	TYPE = 00000A03 [CR] [LF] (Displayed in hexadecimal)
YSPEC	INDEXER Module Special Specification No. Display	YSPEC = 12345678 [CR] [LF]
VER	INDEXER Module Firmware Version Display	VER = 00001234 [CR] [LF] (Displayed in hexadecimal)
SVTYPE	SERVOPACK Model Code Display SGDV-□□□□E1A = 2A SGDV-□□□□E5A = 2D	SVTYPE = 0000002A [CR] [LF] (Displayed in hexadecimal)
SVYSPEC	SERVOPACK Special Specification No. Display	SVYSPEC = 12345678 [CR] [LF]
SVVER	SERVOPACK Firmware Version Display	SVVER = 12345678 [CR] [LF] (Displayed in hexadecimal)

Monitor and Utility Function Commands (cont'd)

Serial Command	Function/Description	Positive Response
MTTYPE	Motor Model Code Display <div style="text-align: center;"> $\begin{array}{c} 0 \ 1 \ 1 \ 1 \\ \hline \downarrow \ \downarrow \ \downarrow \\ \text{Voltage} \quad \text{Motor model} \end{array}$ </div> 00 = 100 VAC 11 = SGMMJ 01 = 200 VAC 32 to 39 = SGMCS 02 = 400 VAC 40 = linear motor 60 = SGMAV 62 = SGMSV 63 = SGMGV 6D = SGMJV 6E = SGMEV FF = Undefined motor	MTTYPE = 00001234 [CR] [LF] (Displayed in hexadecimal)
MTSIZE	Motor Capacity Display [10 W]	MTSIZE = 12345678 [CR] [LF]
PGTYPE	Encoder Model Code Display 000D: 13-bit incremental encoder 0011: 17-bit incremental encoder 0014: 20-bit incremental encoder 0110: 16-bit absolute encoder 0111: 17-bit absolute encoder 0114: 20-bit absolute encoder (multi-turn) 0214: 20-bit absolute encoder (within one rotation) When fully-closed loop control is selected and linear motor is used: 0008: 8-bit serial converter unit 000C: 12-bit serial converter unit 0008: 8-bit incremental scale 0009: 9-bit incremental scale 000A: 10-bit incremental scale 000D: 13-bit incremental scale 0109: 9-bit absolute scale 010A: 10-bit absolute scale Note: When fully-closed loop control is selected, the external encoder's information is displayed.	PGTYPE = 00001234 [CR] [LF] (Displayed in hexadecimal)
PGVER	Encoder Firmware Version Display Note: When fully-closed loop control is selected, the external encoder's information is displayed.	PGVER = 00001234 [CR] [LF] (Displayed in hexadecimal)
ABSPGRES	Absolute Encoder Reset	OK
MLTLIMSET	Multi-turn Limit Setting	OK
ALMTRCCLR	Alarm Trace Clear	OK
CURZERO	Motor Current Zero Adjustment	OK

Operation of Digital Operator

This chapter describes how to operate the digital operator when an INDEXER Module is installed. For details on the basic operation of the digital operator, refer to the following manuals.

- *Σ-V Series User's Manual Design and Maintenance Rotational Motor Command Option Attachable Type* (SIEP S800000 60)
- *Σ-V Series User's Manual Design and Maintenance Linear Motor Command Option Attachable Type* (SIEP S800000 66)
- *Σ-V Series User's Manual Operation of Digital Operator* (SIEP S800000 55)

The information given in this chapter applies to the following software versions.

INDEXER Module: Version 3 or later
SERVOPACK: Version 001B or later

8.1 Overview	8-2
8.1.1 Functions List	8-2
8.1.2 Changing the Function	8-2
8.1.3 Reading the Screen	8-3
8.2 Operation of Utility Functions	8-4
8.2.1 Utility Functions	8-4
8.2.2 Program Table Edit/Save (FnB03)	8-6
8.2.3 ZONE Table Edit/Save (FnB04)	8-11
8.2.4 JOG Speed Table Edit/Save (FnB05)	8-14
8.2.5 Program Table Initialization (FnB06)	8-16
8.2.6 ZONE Table Initialization (FnB07)	8-17
8.2.7 JOG Speed Table Initialization (FnB08)	8-18
8.2.8 Absolute Encoder Origin Setting (FnB09)	8-19
8.2.9 INDEXER Status Monitor (FnB0A)	8-21
8.2.10 INDEXER Parameter Setting Initialization (FnB0B)	8-24
8.2.11 INDEXER Alarm Reset (FnB0C)	8-25
8.2.12 INDEXER Alarm History Display (FnB0D)	8-27

8.1 Overview

8.1.1 Functions List

The table below shows whether functions of the digital operator can or cannot be used when an INDEXER Module is installed.

This chapter describes the operating procedures for the functions indicated with the thick-bordered frame in the table below. For details on functions other than those indicated by the thick-bordered frame, refer to *Σ-V Series User's Manual Operation of Digital Operator* (SIEP S800000 55).

	Parameters/Monitoring Functions			Utility Functions		Parameter Copy Functions	
	SERVOPACK Parameters	SERVOPACK Monitor Display	INDEXER Module Parameters	SERVOPACK Utility Functions	INDEXER Module Utility Functions	SERVOPACK Parameters	INDEXER Module Parameters
	Pn000 to Pn95F	Un000 to Un085	PnB00 to PnB52	Fn000 to Fn207	FnB03 to FnB0D	Pn000 to Pn95F	PnB00 to PnB52
When an INDEXER Module is installed	○	○	○	○	○	○	×*
When no INDEXER Module is installed	○	○	×	○	×	○	×

* To copy the INDEXER Module parameters (PnB00 to PnB52), use the SigmaWin+ parameter editing function.

8.1.2 Changing the Function

Connect the digital operator to the SERVOPACK, and turn ON the power to the SERVOPACK. The initial display appears, and then the Parameter/Monitoring Function screen appears. Press the  key to change the function.

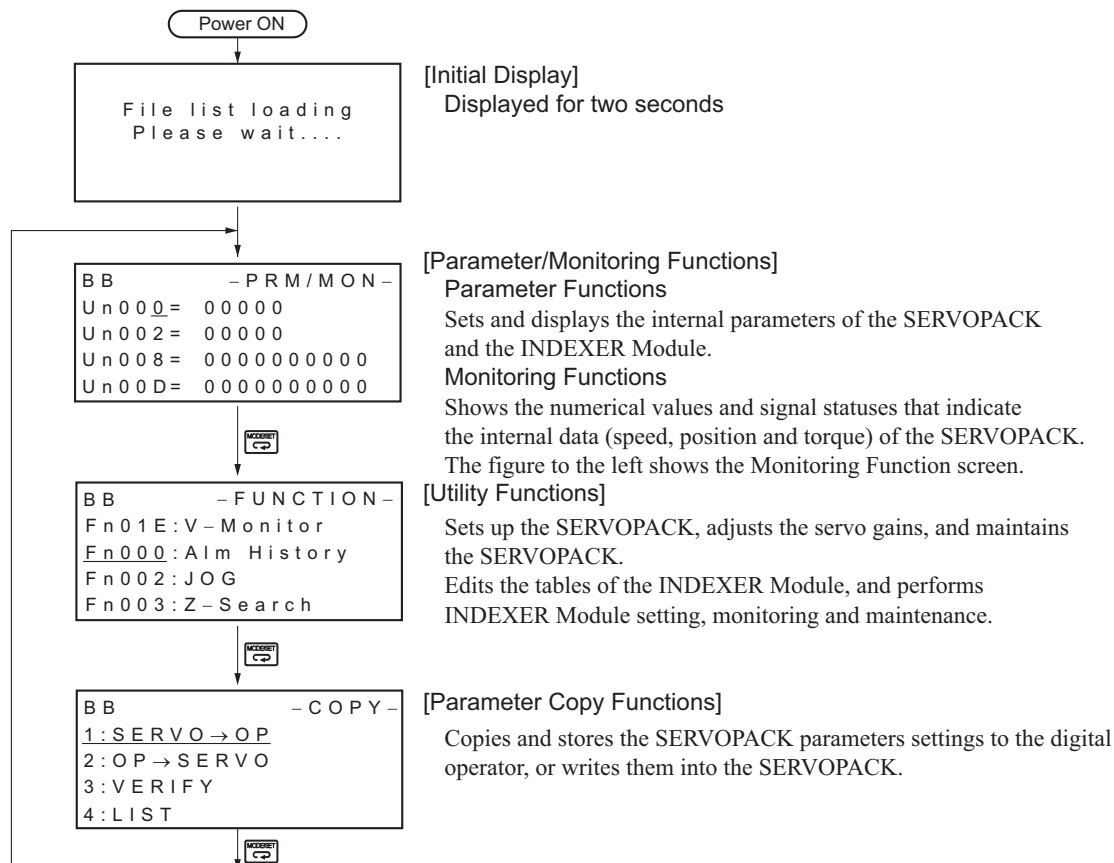

8.1.3 Reading the Screen

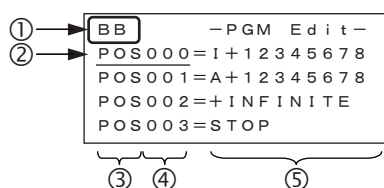

- The SERVOPACK status is always displayed at the top left of the screen (①).

BB: Base blocked
 RUN: Servomotor is ON
 A.□□□ : Alarm/warning is in effect (□□□ is the alarm/warning code).
 PT NT: Forward run and reverse run prohibited (Over travel)*
 P-OT: Forward run prohibited (Over travel)*
 N-OT: Reverse run prohibited (Over travel)*
 P-LS: Forward software limit*
 N-LS: Reverse software limit*
 NO-OP: Setting disabled or setting error
 HBB: During hard wire base block

* Overtravel and software limit indications are supported by the following software version.
 INDEXER Module: Version 3 or later
 SERVOPACK: Version 001B or later.

- The figure of editing screen used in the program tables, ZONE tables and JOG speed tables has the following elements.

② : The article and table number currently selected
 ③ : The article of the table
 ④ : The table number
 ⑤ : The table settings

Note: The line beneath POS000 shows that this indication is flashing. This line does not appear on the actual screen. Note also that the part that flashes is referred to as the cursor in this document.

8.2 Operation of Utility Functions

8.2.1 Utility Functions

The following table shows whether utility functions can be set or not with the digital operator.

Fn No.	Function	Possible/ Not Possible	Remarks and Reference
Fn000	Alarm history display	×	This utility function cannot be used. Execute FnB0D instead.
Fn002	JOG operation	○	<ul style="list-style-type: none"> • <i>Σ-V Series User's Manual Design and Maintenance Rotational Motor Command Option Attachable Type</i> (SIEP S800000 60) • <i>Σ-V Series User's Manual Design and Maintenance Linear Motor Command Option Attachable Type</i> (SIEP S800000 66)
Fn003	Origin search	○	
Fn004	Program JOG operation	○	
Fn005	Initializing parameter settings	×	This utility function cannot be used. Execute FnB0B instead.
Fn006	Clearing alarm history	×	This utility function cannot be used. Execute FnB0C instead.
Fn008	Absolute encoder multiturn reset and encoder alarm reset	○	<ul style="list-style-type: none"> • <i>Σ-V Series User's Manual Design and Maintenance Rotational Motor Command Option Attachable Type</i> (SIEP S800000 60) • <i>Σ-V Series User's Manual Design and Maintenance Linear Motor Command Option Attachable Type</i> (SIEP S800000 66)
Fn00C	Offset adjustment of analog monitor output	○	
Fn00D	Gain adjustment of analog monitor output	○	
Fn00E	Automatic offset-signal adjustment of motor current detection signal	○	
Fn00F	Manual offset-signal adjustment of motor current detection signal	○	
Fn010	Write prohibited setting	○	
Fn011	Servomotor model display	○	
Fn012	SERVOPACK software version display	○	
Fn013	Multiturn limit value setting change when a multiturn limit disagreement alarm (A.CC0) occurs	○	
Fn014	Resetting configuration error in option module	○	
Fn01B	Vibration detection level initialization	○	
Fn01E	Display of SERVOPACK and servomotor ID	○	
Fn01F	Display of servomotor ID in feedback option module	○	
Fn020	Origin setting	○	
Fn030	Software reset	○	
Fn080	Polarity detection	○	
Fn200	Tuning-less levels setting	○	
Fn201	Advanced autotuning	○	
Fn202	Advanced autotuning by reference	○	
Fn203	One-parameter tuning	○	
Fn204	Anti-resonance control adjustment function	○	
Fn205	Vibration suppression function	○	
Fn206	EasyFFT	○	
Fn207	Online vibration monitor	○	
FnB03	Program table edit/save	○	8.2.2

○: Possible ×: Not possible

(cont'd)

Fn No.	Function	Possible/ Not Possible	Remarks and Reference
FnB04	ZONE table edit/save	○	8.2.3
FnB05	JOG speed table edit/save	○	8.2.4
FnB06	Program table initialization	○	8.2.5
FnB07	ZONE table initialization	○	8.2.6
FnB08	JOG speed table initialization	○	8.2.7
FnB09	Absolute encoder origin setting	○	8.2.8
FnB0A	INDEXER status monitor	○	8.2.9
FnB0B	INDEXER parameter setting initialization	○	8.2.10
FnB0C	INDEXER alarm reset	○	8.2.11
FnB0D	INDEXER alarm history display	○	8.2.12

○: Possible ×: Not possible

8.2.2 Program Table Edit/Save (FnB03)

This function edits and saves program tables. Saving a program table to flash memory after editing it ensures that the data will be retained even after the control power has been turned off.

■ Codes Displayed on the Program Table Editing Screen

For details on how to read the screen, refer to 8.1.3 *Reading the Screen*.

PGMSTEP	POS	SPD	RDST	RSPD	ACC	DEC	POUT	EVENT	LOOP	NEXT
0	POS000	SPD000	RDST000	RSPD000	ACC000	DEC000	POUT000	EVT000	LOOP000	NEXT000
1	POS001	SPD001	RDST001	RSPD001	ACC001	DEC001	POUT001	EVT001	LOOP001	NEXT001
⋮	⋮	⋮	⋮	⋮	⋮	⋮	⋮	⋮	⋮	⋮
255	POS255	SPD255	RDST255	RSPD255	ACC255	DEC255	POUT255	EVT255	LOOP255	NEXT255



































(1) Preparation

The following conditions must be met to edit and save program tables.

- The write-prohibited setting (Fn010) must not be set to write-protect parameters.
- The program must not be running or on hold.
- The program tables must not be saved by any other means than using the digital operator.
- The RES command must not be executed.

(2) Editing Program Table

The operating procedure when setting the acceleration (ACC) in program step 5 is explained here.

Step	Display after Operation	Keys	Operation
1	<pre>BB -FUNCTION- Fn207 V-Monitor FnB03 PGM Edit FnB04 ZONE Edit FnB05 JSPD Edit</pre>	  	Press the  key to open the Utility Function Mode main menu, and move the cursor with the   keys to select FnB03.
2	<pre>BB -PGM Edit- POS000=STOP POS001=STOP POS002=STOP POS003=STOP</pre>		Press the  key to view the FnB03 operation screen.
3	<pre>BB -PGM Edit- ACC002=: ACC003=: ACC004=: ACC005=:</pre>	     +   + 	Move the cursor using the   keys and   keys (or the  +  and  +  keys) to select the article and program step of the program table to be edited. For details on how to move the cursor, refer to ■ <i>Method for Moving the Cursor</i> .
4	<pre>BB -PGM Edit- ACC002=: ACC003=: ACC004=: ACC005=:</pre>		Press the  key to move the cursor to the setting side of the table.
5	<pre>BB -PGM Edit- ACC002=: ACC003=: ACC004=: ACC005=0000_1000</pre>	   	Move the cursor with the   keys, and change the table settings with the   keys.* For details on how to set each field, refer to (3) <i>Details on How to Set Table Settings</i> .

* If setting is attempted in an operation prohibited state, it will not be possible to change the setting. In this case, make the setting again by referring to (1) *Preparation*.

(cont'd)

Step	Display after Operation	Keys	Operation
6	<pre> BB - PGM Edit - ACC002=: ACC003=: ACC004=: ACC005=00001000 </pre>	<div style="border: 1px solid black; padding: 2px; display: inline-block;">DATA</div>	On pressing the DATA key, the setting is entered and the cursor returns to the program table article and program step side.
7	Repeat steps 3 to 6 to set the program table. On completing the setting of all the program tables to be used, save the program tables to flash memory by following the procedure in (4) Saving Program Tables.		

■ Method for Moving the Cursor

The values within the frames in the figure below are the articles and steps of the program table displayed at the digital operator.

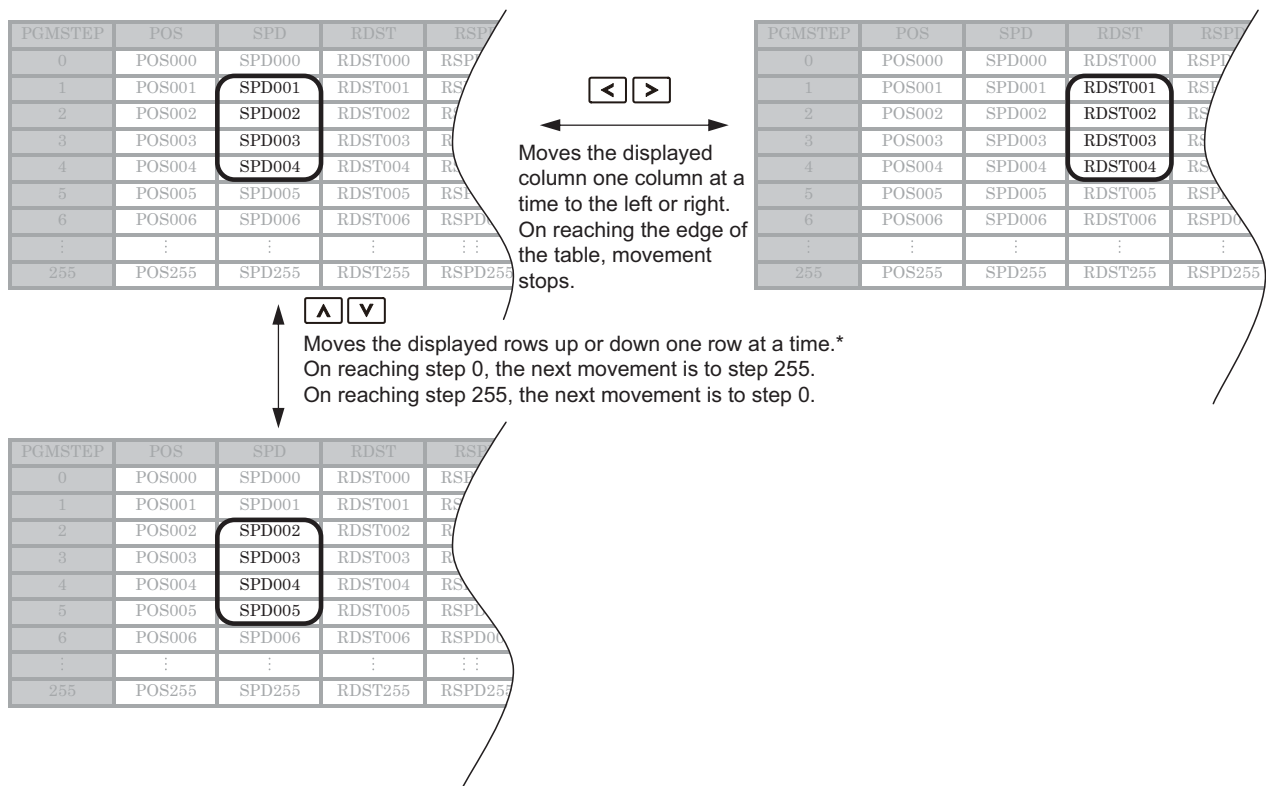

* You can move 4 rows at a time by holding down the ▲ or ▼ key. By using the SCROLL key at the same time as these keys, you can move 30 rows at a time.

(3) Details on How to Set Table Settings

Details on the setting method for step 5 in 8.2.2 (2) *Editing Program Table* are shown below.

■ POS: Target Position



Note: For details on the positioning type and target position, refer to 6.1.4 (1) *Program Table Functions*.

■ SPD: Positioning Speed

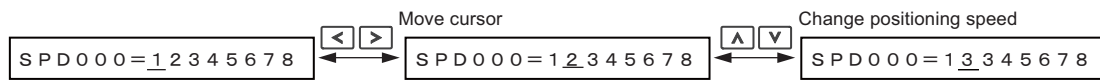

Note: For details on the positioning speed, refer to 6.1.4 (1) *Program Table Functions*.

■ RDST: Registration Distance

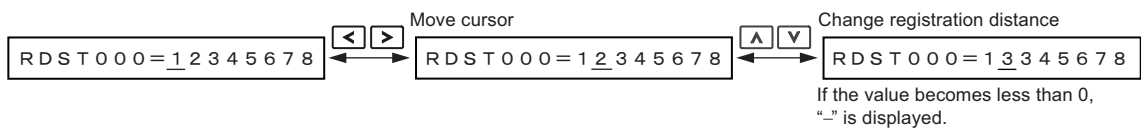

Note: For details on the registration distance, refer to 6.1.4 (1) *Program Table Functions*.

■ RSPD: Registration Speed

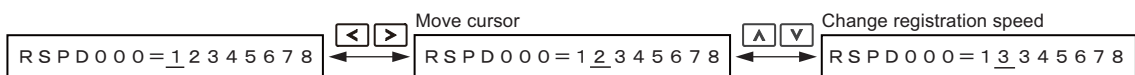

Note: For details on the registration speed, refer to 6.1.4 (1) *Program Table Functions*.

■ ACC: Acceleration

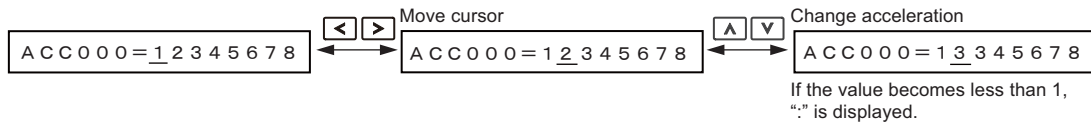

Note: For details on the acceleration, refer to 6.1.4 (1) Program Table Functions.

■ DEC: Deceleration

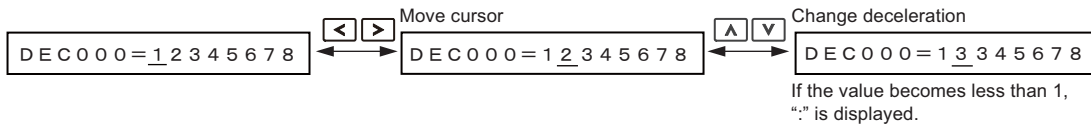

Note: For details on the deceleration, refer to 6.1.4 (1) Program Table Functions.

■ POUT: Programmable Output Signals

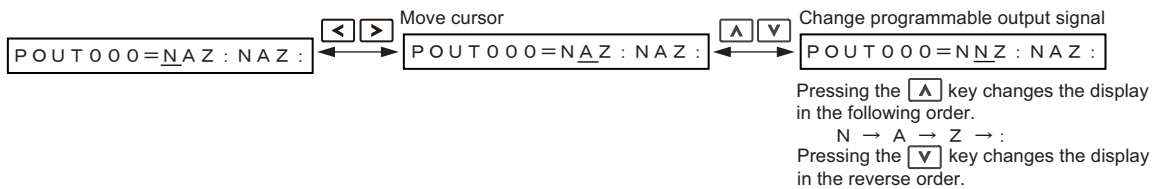

Note: For details on the programmable output signal, refer to 6.1.4 (1) Program Table Functions.

■ EVENT: Pass Condition

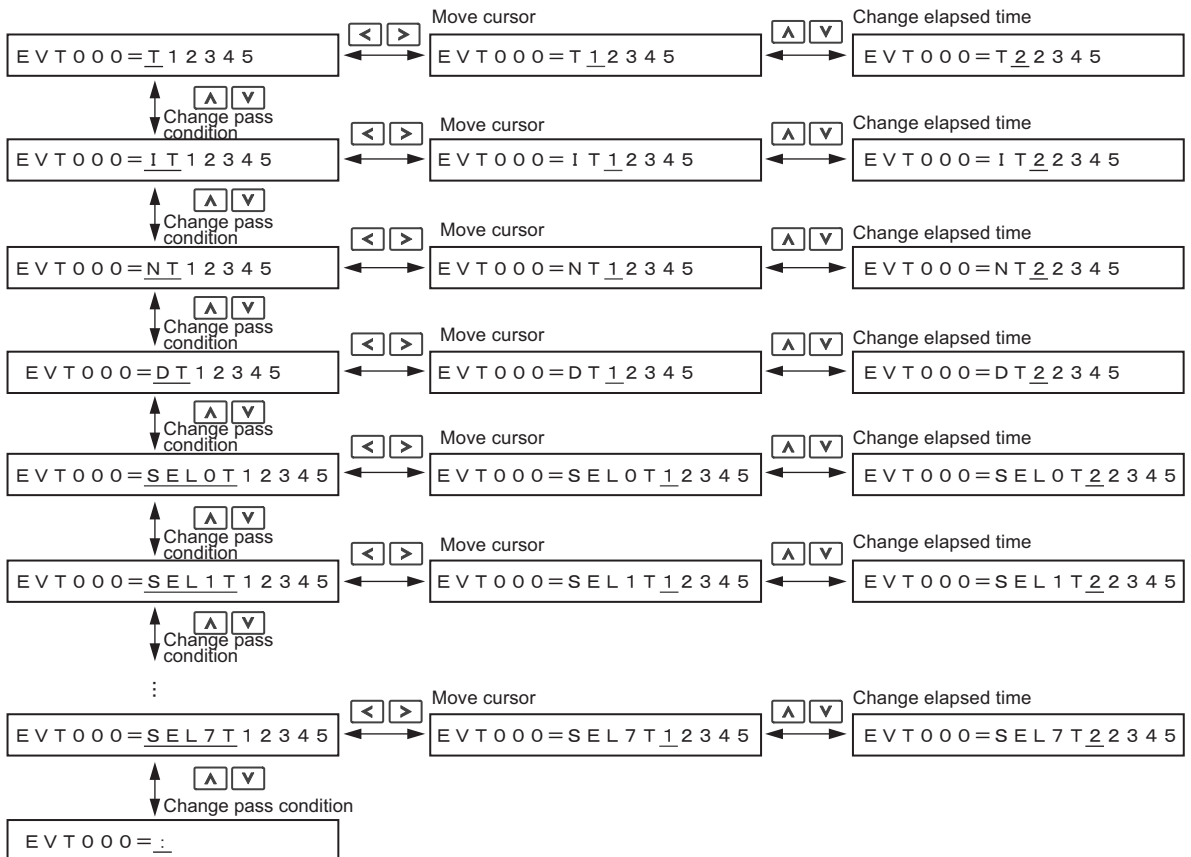

Note: For details on the pass condition and elapsed time, refer to 6.1.4 (1) Program Table Functions.

■ LOOP: Number of Executions

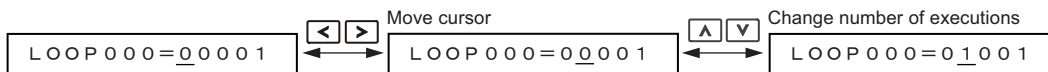

Note: For details on the number of executions, refer to 6.1.4 (1) Program Table Functions.

■ NEXT: PGMSTEP to be Executed Next

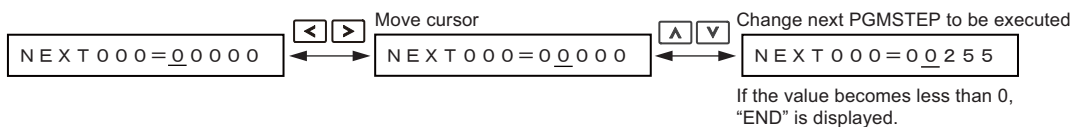

If the value becomes less than 0, "END" is displayed.

Note: For details on the PGMSTEP to be executed next, refer to 6.1.4 (1) Program Table Functions.

(4) Saving Program Tables

The operating procedure for saving program tables is shown below.

Step	Display after Operation	Keys	Operation
1	<pre>BB -PGM Edit- POS000=STOP POS001=STOP POS002=STOP POS003=STOP</pre>		Display the program table editing screen.
2	<pre>BB -PGM Edit- STORE PGM TABLE? CANCEL STORE</pre>		Press the key to view the program table save operation screen.
3	<pre>BB -PGM Edit- STORE PGM TABLE? CANCEL STORE</pre>		Move the cursor with the keys to select "STORE". Note: Selecting "CANCEL" and pressing the key will return the display to the program table editing screen.
4	<pre>BB -PGM Edit- Storing now... Please wait.</pre>		Press the key to start saving the program table to flash memory.* Do not turn off the control power supply until saving has been completed normally.
5	<pre>BB -PGM Edit- POS000=STOP POS001=STOP POS002=STOP POS003=STOP</pre>		When saving to flash memory has been completed normally, the display returns to the program table editing screen.
6	<pre>BB -FUNCTION- Fn207 V-Monitor FnB03 PGM Edit FnB04 ZONE Edit FnB05 JSPD Edit</pre>		Press the key to return to the Utility Function Mode main menu.

* If the key is pressed in an operation prohibited state, "Error." is displayed for approximately 2 seconds and then the display returns to the program table editing screen. In this case, make the setting again by referring to (1) Preparation.

8.2.3 ZONE Table Edit/Save (FnB04)

This function edits and saves ZONE tables. Saving a ZONE table to flash memory after editing it ensures that the data will be retained even after the control power has been turned off.

■ Codes Displayed on the ZONE Table Editing Screen

For details on how to read the screen, refer to 8.1.3 *Reading the Screen*.

ZONE Number	ZONEP	ZONEN
0	ZP000	ZN000
1	ZP001	ZN001
⋮	⋮	⋮
31	ZP031	ZN031





























(1) Preparation

The following conditions must be met to edit and save ZONE tables.

- The write-prohibited setting (Fn010) must not be set to write-protect parameters.
- The ZONE tables must not be saved by any other means than using the digital operator.

(2) Editing ZONE Tables

The operating procedure when setting ZONEN in ZONE number 5 is explained here.

Step	Display after Operation	Keys	Operation
1	<pre>BB -FUNCTION- FnB03 PGM Edit FnB04 ZONE Edit FnB05 JSPD Edit FnB06 PGM Init</pre>	  	Press the  key to open the Utility Function Mode main menu, and move the cursor with the   keys to select FnB04.
2	<pre>BB -ZONE Edit- ZP000=+00000000 ZP001=+00000000 ZP002=+00000000 ZP003=+00000000</pre>		Press the  key to view the FnB04 operation screen.
3	<pre>BB -ZONE Edit- ZN002=+00000000 ZN003=+00000000 ZN004=+00000000 ZN005=+00000000</pre>	   	Move the cursor using the   keys and   keys to select the ZONE table number to be edited. For details on how to move the cursor, refer to ■ <i>Method for Moving the Cursor</i> .
4	<pre>BB -ZONE Edit- ZN002=+00000000 ZN003=+00000000 ZN004=+00000000 ZN005=+00000000</pre>		Press the  key to move the cursor to the setting side of the table.
5	<pre>BB -ZONE Edit- ZN002=+00000000 ZN003=+00000000 ZN004=+00000000 ZN005=+12345678</pre>	   	Move the cursor using the   keys and change the ZONE boundary values using the   keys.*
6	<pre>BB -ZONE Edit- ZN002=+00000000 ZN003=+00000000 ZN004=+00000000 ZN005=+12345678</pre>		On pressing the  key, the setting is entered and the cursor returns to the ZONE table number side.
7	Repeat steps 3 to 6 to set the ZONE table. On completing the setting of all the ZONE tables to be used, save the ZONE tables to flash memory by following the procedure in (3) <i>Saving ZONE Tables</i> .		

* If setting is attempted in an operation prohibited state, it will not be possible to change the setting. In this case, make the setting again by referring to (1) *Preparation*.

■ Method for Moving the Cursor

The values within the frames in the figure below are the ZONE table numbers displayed at the digital operator.

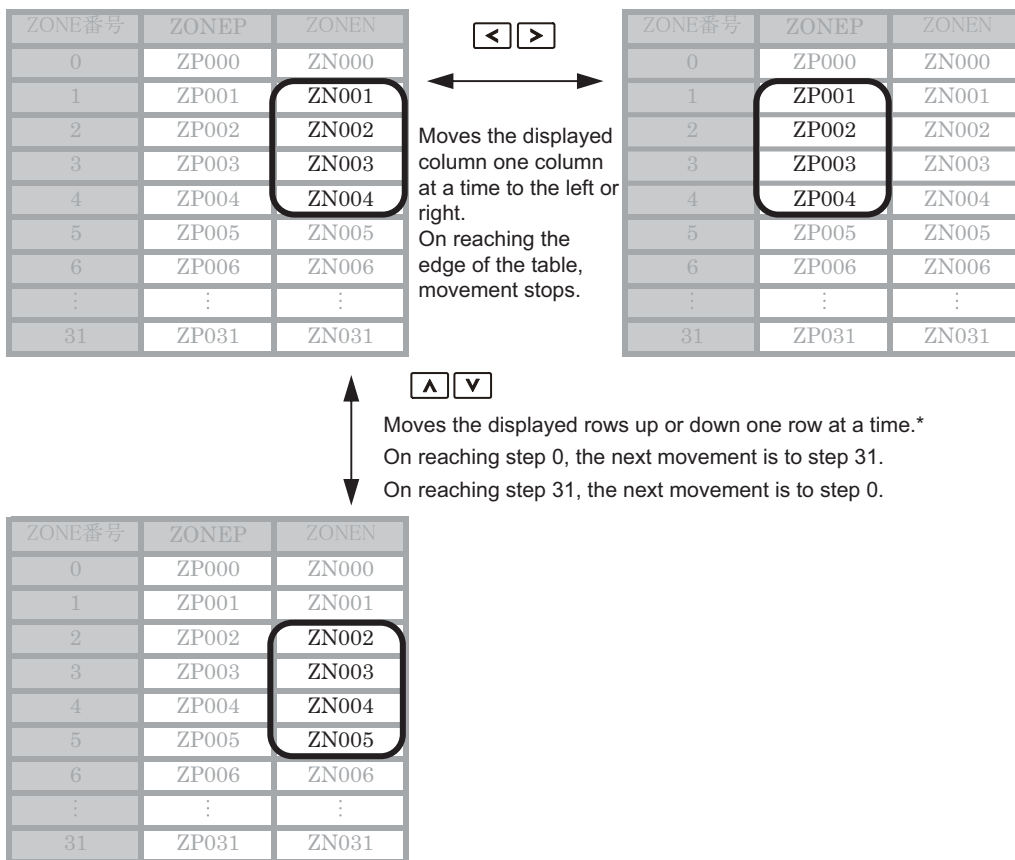



* You can move 3 rows at a time by holding down the or key.

(3) Saving ZONE Tables

The operating procedure for saving ZONE tables is shown below.

Step	Display after Operation	Keys	Operation
1	<pre>BB -ZONE Edit- ZP000=+00000000 ZP001=+00000000 ZP002=+00000000 ZP003=+00000000</pre>		Display the ZONE table editing screen.
2	<pre>BB -ZONE Edit- STORE ZONE TABLE? CANCEL STORE</pre>		Press the key to view the ZONE table save screen.
3	<pre>BB -ZONE Edit- STORE ZONE TABLE? CANCEL STORE</pre>		Move the cursor with the keys to select "STORE". Note: Selecting "CANCEL" and pressing the key will return the display to the ZONE table editing screen.
4	<pre>BB -ZONE Edit- Storing now... Please wait.</pre>		Press the key to start saving the ZONE table to flash memory.* Do not turn off the control power supply until saving has been completed normally.

(cont'd)

Step	Display after Operation	Keys	Operation
5	<pre> BB - ZONE Edit - ZP000=+000000000 ZP001=+000000000 ZP002=+000000000 ZP003=+000000000 </pre>		When saving to flash memory has been completed normally, the display returns to the ZONE table editing screen.
6	<pre> BB - FUNCTION - FnB03 PGM Edit FnB04 ZONE Edit FnB05 JSPD Edit FnB06 PGM Init </pre>		Press the  key to return to the Utility Function Mode main menu.

- * If the  key is pressed in an operation prohibited state, "Error." is displayed for approximately 2 seconds and then the display returns to the ZONE table editing screen. In this case, make the setting again by referring to (1) *Preparation*.

8.2.4 JOG Speed Table Edit/Save (FnB05)

This function edits and saves JOG speed tables. Saving a JOG speed table to flash memory after editing it ensures that the data will be retained even after the control power has been turned off.

For details on how to read the screen, refer to 8.1.3 *Reading the Screen*.



























(1) Preparation

The following conditions must be met to save and edit JOG speed tables.

- The write-prohibited setting (Fn010) must not be set to write-protect parameters.
- The JOG speed tables must not be saved by any other means than using the digital operator.

(2) Editing JOG Speed Tables











The operating procedure when setting the value for JOG speed table number 5 is explained here.

Step	Display after Operation	Keys	Operation
1	<pre>BB -FUNCTION- FnB04 ZONE Edit FnB05 JSPD Edit FnB06 PGM Init FnB07 ZONE Init</pre>	  	Press the  key to open the Utility Function Mode main menu, and move the cursor with the   keys to select FnB05.
2	<pre>BB -JSPD Edit- JSPD000=00001000 JSPD001=00001000 JSPD002=00001000 JSPD003=00001000</pre>		Press the  key to view the FnB05 operation screen.
3	<pre>BB -JSPD Edit- JSPD002=00001000 JSPD003=00001000 JSPD004=00001000 JSPD005=00001000</pre>	 	Move the cursor using the   keys to select the JOG speed table number to be edited. Note: Pressing the  key when the cursor is on JOG speed table number 0 moves it to number 15. Pressing the  key when the cursor is on JOG speed table number 15 moves it to number 0.
4	<pre>BB -JSPD Edit- JSPD002=00001000 JSPD003=00001000 JSPD004=00001000 JSPD005=00001000</pre>		Press the  key to move the cursor to the setting side of the table.
5	<pre>BB -JSPD Edit- JSPD002=00001000 JSPD003=00001000 JSPD004=00001000 JSPD005=1234567<u>8</u></pre>	   	Move the cursor with the   keys, and change the JOG speed setting with the   keys.*
6	<pre>BB -JSPD Edit- JSPD002=00001000 JSPD003=00001000 JSPD004=00001000 JSPD005=12345678</pre>		On pressing the  key, the setting is entered and the cursor returns to the JOG speed table number side.
7	Repeat steps 3 to 6 to set the JOG speed table. On completing the setting of all the JOG speed tables to be used, save the JOG speed tables to flash memory by following the procedure in (3) <i>Saving JOG Speed Tables</i> .		

* If setting is attempted in an operation prohibited state, it will not be possible to change the setting. In this case, make the setting again by referring to (1) *Preparation*.

(3) Saving JOG Speed Tables

The operating procedure for saving JOG speed tables is shown below.

Step	Display after Operation	Keys	Operation
1	<pre>BB -JSPD Edit- JSPD000=00001000 JSPD001=00001000 JSPD002=00001000 JSPD003=00001000</pre>		Display the JOG speed table editing screen.
2	<pre>BB -JSPD Edit- STORE JSPD TABLE? CANCEL STORE</pre>		Press the  key to view the JOG speed table save screen.
3	<pre>BB -JSPD Edit- STORE JSPD TABLE? CANCEL STORE</pre>	 	Move the cursor with the   keys to select "STORE". Note: Selecting "CANCEL" and pressing the  key will return the display to the JOG speed table editing screen.
4	<pre>BB -JSPD Edit- Storing now... Please wait.</pre>		Press the  key to start saving the JOG speed table to flash memory.* Do not turn off the control power supply until saving has been completed normally.
5	<pre>BB -JSPD Edit- JSPD000=00001000 JSPD001=00001000 JSPD002=00001000 JSPD003=00001000</pre>		When saving to flash memory has been completed normally, the display returns to the JOG speed table editing screen.
6	<pre>BB -FUNCTION- FnB04 ZONE Edit FnB05 JSPD Edit FnB06 PGM Init FnB07 ZONE Init</pre>		Press the  key to return to the Utility Function Mode main menu.

* If the  key is pressed in an operation prohibited state, "Error." is displayed for approximately 2 seconds and then the display returns to the JOG speed table editing screen. In this case, make the setting again by referring to (1) Preparation.

8.2.5 Program Table Initialization (FnB06)















This function initializes the program tables and restores the settings on shipment from the factory.

(1) Preparation

The following conditions must be met to initialize the program table.

- The write-prohibited setting (Fn010) must not be set to write-protect parameters.
- The program must not be running or on hold.
- The program tables must not be saved by any other means than using the digital operator.
- The RES command must not be executed.

(2) Operating Procedure

Step	Display after Operation	Keys	Operation
1	<pre>BB -FUNCTION- FnB05 JSPD Edit FnB06 PGM Init FnB07 ZONE Init FnB08 JSPD Init</pre>	  	Press the  key to open the Utility Function Mode main menu, and move the cursor with the   keys to select FnB06.
2	<pre>BB -PGM Init- Start : [DATA] Return : [SET]</pre>		Press the  key to view the FnB06 operation screen.
3	<pre>BB -PGM Init- Restoring now... Please wait.</pre>		<p>Press the  key to start program table initialization.* Do not turn off the control power supply until initialization has been completed normally.</p> <p>To cancel the FnB06 operation, press the  key before pressing the  key. The display returns to the Utility Function Mode main menu without executing the operation.</p>
4	<pre>BB -PGM Init- Done. Press [SET] key.</pre>		When program table initialization has been completed normally, "Done." is displayed.
5	<pre>BB -FUNCTION- FnB05 JSPD Edit FnB06 PGM Init FnB07 ZONE Init FnB08 JSPD Init</pre>		Press the  key to return to the Utility Function Mode main menu.

* If the  key is pressed in an operation prohibited state, "Error." is displayed for approximately 2 seconds and then the display returns to the FnB06 operation screen. In this case, make the setting again by referring to (1) Preparation.

8.2.6 ZONE Table Initialization (FnB07)















This function initializes ZONE tables and restores the settings on shipment from the factory.

(1) Preparation

The following conditions must be met to initialize ZONE tables.

- The write-prohibited setting (Fn010) must not be set to write-protect parameters.
- The ZONE tables must not be saved by any other means than using the digital operator.
- The RES command must not be executed.

(2) Operating Procedure

Step	Display after Operation	Keys	Operation
1	<pre>BB -FUNCTION- FnB06 PGM Init FnB07 ZONE Init FnB08 JSPD Init FnB09 ZSET</pre>	  	Press the  key to open the Utility Function Mode main menu, and move the cursor with the   keys to select FnB07.
2	<pre>BB -ZONE Init- Start : [DATA] Return: [SET]</pre>		Press the  key to view the FnB07 operation screen.
3	<pre>BB -ZONE Init- Restoring now... Please wait.</pre>		Press the  key to start ZONE table initialization.* Do not turn off the control power supply until initialization has been completed normally. To cancel the FnB07 operation, press the  key before pressing the  key. The display returns to the Utility Function Mode main menu without executing the operation.
4	<pre>BB -ZONE Init- Done. Press [SET] key.</pre>		When ZONE table initialization has been completed normally, "Done." is displayed.
5	<pre>BB -FUNCTION- FnB06 PGM Init FnB07 ZONE Init FnB08 JSPD Init FnB09 ZSET</pre>		Press the  key to return to the Utility Function Mode main menu.

* If the  key is pressed in an operation prohibited state, "Error." is displayed for approximately 2 seconds and then the display returns to the FnB07 operation screen. In this case, make the setting again by referring to (1) Preparation.

8.2.7 JOG Speed Table Initialization (FnB08)















This function initializes JOG speed tables and restores the factory settings.

(1) Preparation

The following conditions must be met to initialize JOG speed tables.

- The write-prohibited setting (Fn010) must not be set to write-protect parameters.
- The JOG speed tables must not be saved by any other means than using the digital operator.
- The RES command must not be executed.

(2) Operating Procedure

Step	Display after Operation	Keys	Operation
1	<pre>BB -FUNCTION- FnB07 ZONE Init FnB08 JSPD Init FnB09 ZSET FnB0A Monitor</pre>	  	Press the  key to open the Utility Function Mode main menu, and move the cursor with the   keys to select FnB08.
2	<pre>BB -JSPD Init- Start : [DATA] Return : [SET]</pre>		Press the  key to view the FnB08 operation screen.
3	<pre>BB -JSPD Init- Restoring now... Please wait.</pre>		<p>Press the  key to start JOG speed table initialization.*</p> <p>Do not turn off the control power supply until initialization has been completed normally.</p> <p>To cancel the FnB08 operation, press the  key before pressing the  key. The display returns to the Utility Function Mode main menu without executing the operation.</p>
4	<pre>BB -JSPD Init- Done. Press [SET] key.</pre>		When JOG speed table initialization has been completed normally, "Done." is displayed.
5	<pre>BB -FUNCTION- FnB07 ZONE Init FnB08 JSPD Init FnB09 ZSET FnB0A Monitor</pre>		Press the  key to return to the Utility Function Mode main menu.

* If the  key is pressed in an operation prohibited state, "Error." is displayed for approximately 2 seconds and then the display returns to the FnB08 operation screen. In this case, make the setting again by referring to (1) Preparation.

8.2.8 Absolute Encoder Origin Setting (FnB09)

This utility function replaces the current position with a specified position. Also updates PnB25 with the absolute position offset value to achieve the position specified by this utility function.

DANGER

- This function replaces the coordinates of the reference position and is therefore very dangerous. After executing this function, check that the new coordinates match the reference position before starting operation.



IMPORTANT





















- If the settings for any of parameters Pn20E to Pn210, Pn205, or PnB20 to PnB25 have been changed, turn the control power supply off and back on to bring the settings into effect before executing operation.
- The absolute position offset value is saved in parameter PnB25, so do not rewrite this value.

(1) Preparation

The following conditions must be met to perform the absolute encoder origin setting.



- The write-prohibited setting (Fn010) must not be set to write-protect parameters.
- Position references must not be distributed.
- The absolute position offset value must not be outside the range for PnB25.
- The absolute encoder must be connected and the setting for Pn002.2 must be 0.

(2) Operating Procedure

Step	Display after Operation	Keys	Operation
1	<pre>BB -FUNCTION- FnB08 JSPD Init FnB09 ZSET FnB0A Monitor FnB0B Prm Init</pre>	  	Press the  key to open the Utility Function Mode main menu, and move the cursor with the   keys to select FnB09.
2	<pre>BB -ZSET- Pos=+00000000 Start : [DATA] Return: [SET]</pre>		Press the  key to view the FnB09 operation screen.
3	<pre>BB -ZSET- Pos=+0000_1000 Start : [DATA] Return: [SET]</pre>	   	Move the cursor with the   keys, and change the setting for the position whose current position is to be replaced with the   keys.
4	<pre>BB -ZSET- Storing now...</pre>		Press the  key to start origin setting.* Do not turn off the control power supply until origin setting has been completed normally. To cancel the FnB09 operation, press the  key before pressing the  key. The display returns to the Utility Function Mode main menu without executing the operation.
5	<pre>BB -ZSET- Done. Press [SET] key.</pre>		When origin setting has been completed normally, "Done." is displayed.

* If the  key is pressed in an operation prohibited state, "Error." is displayed for approximately 2 seconds and then the display returns to the FnB09 operation screen. In this case, make the setting again by referring to (1) Preparation.

(cont'd)

Step	Display after Operation	Keys	Operation
6	<pre> BB -FUNCTION- FnB08 JSPD Init FnB09 ZSET FnB0A Monitor FnB0B Prm Init </pre>		Press the  key to return to the Utility Function Mode main menu.
7	Check that the current distributed position (PUN) and the current (actual) motor position (PFB) have changed to the specified positions by executing FnB0A.		

















8.2.9 INDEXER Status Monitor (FnB0A)

This function shows the internal status of the INDEXER Module, such as the current position and input/output signals.

(1) Preparation

None



(2) Operating Procedure

Step	Display after Operation	Keys	Operation
1	<pre>BB -FUNCTION- FnB09 ZSET FnB0A Monitor FnB0B Prm Init FnB0C ALM Reset</pre>	  	Press the  key to open the Utility Function Mode main menu, and move the cursor with the   keys to select FnB0A.
2	<pre>BB -MONITOR- ALM=BB ERR=NONE PFB=+12345678 PGMSTEP=12345</pre>		Press the  key to view the FnB0A operation screen.
3	<pre>BB -MONITOR- STS=■ ■ ■ ■ ■ ■ ■ ■ ■ ■ PUN=+12345678 PFB=+12345678 POS=+12345678</pre>	 	Use the   keys to change the monitor display content. Note: Press the  key to change the content being displayed in the following order. ALM → ERR → IN2 → OUT2 → STS → PUN → PFB → POS → DST → RPOS → RDST → PGMSTEP → EVTIME → LOOP Press the  key to change the content being displayed in the reverse order.
4	<pre>BB -FUNCTION- FnB09 ZSET FnB0A Monitor FnB0B Prm Init FnB0C ALM Reset</pre>		Press the  key to return to the Utility Function Mode main menu.

■ Monitor Display Content List

Display Code	Display Content	Display Example	Units	Serial Command
ALM	Alarm or Warning	<ul style="list-style-type: none"> • ALM = A.xxx : A SERVOPACK alarm/warning is in effect (xxx is the alarm/warning code). • ALM = ExxA : An INDEXER Module alarm is in effect (ExxA is the alarm code). • ALM = HBB : During hard wire base block • ALM = P-OT : Forward run prohibited (Over travel) • ALM = N-OT : Reverse run prohibited (Over travel) • ALM = P-LS : Forward software limit • ALM = N-LS : Reverse software limit • ALM = BB : Base blocked • ALM = HOLD : Positioning interrupted • ALM = INPOS : Positioning completed • ALM = NEAR : Near position status reached in positioning • ALM = RUN : Motor running • ALM = . : Status other than above 	-	ALM

(cont'd)

Display Code	Display Content	Display Example	Units	Serial Command																								
ERR	Most Recent (Closest) Error	<ul style="list-style-type: none"> • ERR = NONE: No error • ERR = ExxE: Error code 	–	ERR																								
IN2	INDEXER Module Input Signal	<p>IN2 = </p> <p style="text-align: center;"> 1110 9 8 7 6 5 4 3 2 1 digit</p> <p>Upper level: Photocoupler ON Lower level: Photocoupler OFF</p> <table border="1" style="width: 100%; border-collapse: collapse;"> <thead> <tr> <th style="width: 15%;">Display Digit Number</th> <th>Signal Name</th> </tr> </thead> <tbody> <tr><td>1</td><td>/MODE0/1</td></tr> <tr><td>2</td><td>/START-STOP; /HOME</td></tr> <tr><td>3</td><td>/PGMRES; /JOGP</td></tr> <tr><td>4</td><td>/SEL0; /JOGN</td></tr> <tr><td>5</td><td>/SEL1; /JOG0</td></tr> <tr><td>6</td><td>/SEL2; /JOG1</td></tr> <tr><td>7</td><td>/SEL3; /JOG2</td></tr> <tr><td>8</td><td>/SEL4; /JOG3</td></tr> <tr><td>9</td><td>/SEL5</td></tr> <tr><td>10</td><td>/SEL6</td></tr> <tr><td>11</td><td>/SEL7</td></tr> </tbody> </table>	Display Digit Number	Signal Name	1	/MODE0/1	2	/START-STOP; /HOME	3	/PGMRES; /JOGP	4	/SEL0; /JOGN	5	/SEL1; /JOG0	6	/SEL2; /JOG1	7	/SEL3; /JOG2	8	/SEL4; /JOG3	9	/SEL5	10	/SEL6	11	/SEL7	–	IN2
Display Digit Number	Signal Name																											
1	/MODE0/1																											
2	/START-STOP; /HOME																											
3	/PGMRES; /JOGP																											
4	/SEL0; /JOGN																											
5	/SEL1; /JOG0																											
6	/SEL2; /JOG1																											
7	/SEL3; /JOG2																											
8	/SEL4; /JOG3																											
9	/SEL5																											
10	/SEL6																											
11	/SEL7																											
OUT2	INDEXER Module Output Signal	<p>OUT2 = </p> <p style="text-align: center;"> 9 8 7 6 5 4 3 2 1 digit</p> <p>Upper level: Photocoupler ON Lower level: Photocoupler OFF</p> <table border="1" style="width: 100%; border-collapse: collapse;"> <thead> <tr> <th style="width: 15%;">Display Digit Number</th> <th>Signal Name</th> </tr> </thead> <tbody> <tr><td>1</td><td>/INPOSITION</td></tr> <tr><td>2</td><td>/POUT0</td></tr> <tr><td>3</td><td>/POUT1</td></tr> <tr><td>4</td><td>/POUT2</td></tr> <tr><td>5</td><td>/POUT3</td></tr> <tr><td>6</td><td>/POUT4</td></tr> <tr><td>7</td><td>/POUT5</td></tr> <tr><td>8</td><td>/POUT6</td></tr> <tr><td>9</td><td>/POUT7</td></tr> </tbody> </table>	Display Digit Number	Signal Name	1	/INPOSITION	2	/POUT0	3	/POUT1	4	/POUT2	5	/POUT3	6	/POUT4	7	/POUT5	8	/POUT6	9	/POUT7	–	OUT2				
Display Digit Number	Signal Name																											
1	/INPOSITION																											
2	/POUT0																											
3	/POUT1																											
4	/POUT2																											
5	/POUT3																											
6	/POUT4																											
7	/POUT5																											
8	/POUT6																											
9	/POUT7																											

(cont'd)

Display Code	Display Content	Display Example	Units	Serial Command																
STS	Status Flag	STS =  Upper level: ON Lower level: OFF <table border="1" data-bbox="758 533 1209 1041"> <thead> <tr> <th>Display Digit Number</th> <th>Status Flag</th> </tr> </thead> <tbody> <tr> <td>1</td> <td>INPOSITION (Positioning complete)</td> </tr> <tr> <td>2</td> <td>NEAR (Near position)</td> </tr> <tr> <td>3</td> <td>DEN (positioning reference distribution completed)</td> </tr> <tr> <td>4</td> <td>When positioning or program operation is interrupted (on hold)</td> </tr> <tr> <td>5</td> <td>During program operation</td> </tr> <tr> <td>6</td> <td>When the current (torque) is being limited</td> </tr> <tr> <td>7</td> <td>When the main power supply is ON</td> </tr> </tbody> </table>	Display Digit Number	Status Flag	1	INPOSITION (Positioning complete)	2	NEAR (Near position)	3	DEN (positioning reference distribution completed)	4	When positioning or program operation is interrupted (on hold)	5	During program operation	6	When the current (torque) is being limited	7	When the main power supply is ON	–	STS
Display Digit Number	Status Flag																			
1	INPOSITION (Positioning complete)																			
2	NEAR (Near position)																			
3	DEN (positioning reference distribution completed)																			
4	When positioning or program operation is interrupted (on hold)																			
5	During program operation																			
6	When the current (torque) is being limited																			
7	When the main power supply is ON																			
PUN	Position Reference Current Position	PUN = +12345678	Reference unit	PUN																
PFB	Current (Actual) Motor Position	PFB = +12345678	Reference unit	PFB																
POS	Target Position	POS = +12345678	Reference unit	POS																
DST	Target Distance	DST = +12345678	Reference unit	DST																
RPOS	Registration Target Position	RPOS = +12345678	Reference unit	RPOS																
RDST	Registration Target Distance	RDST = 12345678	Reference unit	RDST																
PGMSTEP	Program Step (PGMSTEP)	PGMSTEP = End: When the program is not running PGMSTEP = 12345: The program step being executed	–	PGMSTEP																
EVTIME	Program EVENT Elapsed Time	EVTIME = 12345	ms	EVTIME																
LOOP	Loop Pass Through	LOOP = 12345	Times	LOOP																

8.2.10 INDEXER Parameter Setting Initialization (FnB0B)

This function restores the factory settings and initializes the parameters of both the SERVOPACK and the INDEXER Module.



IMPORTANT















- Always carry out initialization of the parameter settings in the servo OFF status. It cannot be done in the servo ON status.
- To bring the settings into effect, always turn the SERVOPACK power supply off and back on after this operation.
- The parameters of the INDEXER Module are not initialized with Fn005. To initialize these parameters, execute FnB0B.

(1) Preparation

The following conditions must be met to initialize INDEXER parameter settings.

- The write-prohibited setting (Fn010) must not be set to write-protect parameters.
- The servo OFF status must be established.
- The parameter settings must be not being initialized by any other means than using the digital operator.
- The RES command must not being executed.

(2) Operating Procedure

Step	Display after Operation	Keys	Operation
1	<pre>BB -FUNCTION- FnBOA Monitor FnB0B Prm Init FnBOC ALM Reset FnB0D Indexer ALM</pre>	  	Press the  key to open the Utility Function Mode main menu, and move the cursor with the   keys to select FnB0B.
2	<pre>BB -Prm Init- Start : [DATA] Return: [SET]</pre>		Press the  key to view the FnB0B operation screen.
3	<pre>BB -Prm Init- Restoring now... Please wait.</pre>		<p>Press the  key to start initialization of the parameters.*</p> <p>Do not turn off the control power supply until initialization has been completed normally.</p> <p>To cancel the FnB0B operation, press the  key before pressing the  key. The display returns to the Utility Function Mode main menu without executing the operation.</p>
4	<pre>BB -Prm Init- Done. Press [SET] key.</pre>		When parameter initialization has been completed normally, "Done." is displayed.
5	<pre>BB -FUNCTION- FnBOA Monitor FnB0B Prm Init FnBOC ALM Reset FnB0D Indexer ALM</pre>		Press the  key to return to the Utility Function Mode main menu.
6	To bring the settings into effect, turn the SERVOPACK power supply off and back on.		

* If the  key is pressed in an operation prohibited state, "Error." is displayed for approximately 2 seconds and then the display returns to the FnB0B operation screen. In this case, make the setting again by referring to (1) Preparation.

8.2.11 INDEXER Alarm Reset (FnB0C)

This function resets alarms at both the SERVOPACK and INDEXER Module, and clears the alarm history at the INDEXER Module.



IMPORTANT

- INDEXER Module alarms are not reset by the “ALARM RESET” button of the digital operator. To reset INDEXER Module alarms, execute alarm resetting with FnB0C.
- Eliminate the causes of alarms before resetting them.
- The INDEXER Module alarm history is not cleared with Fn006. To clear it, execute alarm history clearance with FnB0C.

(1) Preparation

■ When Resetting Alarms

None

■ When Clearing the Alarm History

The following conditions must be met to reset INDEXER alarms.



- The write-prohibited setting (Fn010) must not be set to write-protect parameters.
- The ALMTRCLR command must not be executed.
- The RES command must not be executed.

(2) Operating Procedure

Step	Display after Operation	Keys	Operation
1	A. AEF -FUNCTION- FnB0B Prm Init FnB0C ALM Reset FnB0D Indexer ALM Fn000 Alm History	MODE/SET ▲ ▼	Press the key to open the Utility Function Mode main menu, and move the cursor with the keys to select FnB0C.
2	A. AEF -ALM Reset- Mode=ALM state Start : [DATA] Return : [SET]	DATA	Press the key to view the FnB0C operation screen.
3-1	A. AEF -ALM Reset- Mode=ALM state Start : [DATA] Return : [SET]	▲ ▼	<ul style="list-style-type: none"> ■ When Resetting Alarms Use the keys to select “ALM state”.
3-2	A. AEF -ALM Reset- Mode=ALM History Start : [DATA] Return : [SET]	▲ ▼	<ul style="list-style-type: none"> ■ When Clearing the Alarm History Use the keys to select “ALM History”.
4	A. AEF -ALM Reset- Resetting...	DATA	<p>Press the key to reset the alarms or clear the alarm history.*</p> <p>To cancel the FnB0C operation, press the key before pressing the key. The display returns to the Utility Function Mode main menu without executing the operation.</p>
5	BB -ALM Reset- Mode=ALM state Start : [DATA] Return : [SET]		When alarm resetting or alarm history clearance is completed, the display returns to the Mode selection screen.

* If the key is pressed in an operation prohibited state, “Error.” is displayed for approximately 2 seconds and then the display returns to the FnB0C operation screen. In this case, make the setting again by referring to (1) Preparation.

(cont'd)

Step	Display after Operation	Keys	Operation
6	<pre> BB -FUNCTION- FnB0B Prm Init FnB0C ALM Reset FnB0D Indexer ALM Fn000 Alm History </pre>		Press the  key to return to the Utility Function Mode main menu.















8.2.12 INDEXER Alarm History Display (FnB0D)

This function displays the history of alarms that have occurred at the SERVOPACK and INDEXER Module.

(1) Preparation

None

(2) Operating Procedure

Step	Display after Operation	Keys	Operation
1	<pre> BB -FUNCTION- FnB0C ALM Reset FnB0D Indexer ALM Fn000 Alm History Fn002 JOG </pre>	  	Press the  key to open the Utility Function Mode main menu, and move the cursor with the   keys to select FnB0D.
2	<pre> BB -ALM Trace- ALM0=A. F10 ALM1=E19A ALM2=NONE ALM3=NONE </pre>		Press the  key to view the alarm history. Note: If no alarms occur, "NONE" is displayed.
3	<pre> BB -ALM Trace- ALM0=A. F10 ALM1=E19A ALM2=NONE ALM3=NONE </pre> <pre> BB -ALM Trace- ALM1=E19A ALM2=NONE ALM3=NONE ALM4=NONE </pre> <pre> BB -ALM Trace- ALM6=NONE ALM7=NONE ALM8=NONE ALM9=NONE </pre>	 	Use the   keys to scroll the alarm history.
6	<pre> BB -FUNCTION- FnB0C ALM Reset FnB0D Indexer ALM Fn000 Alm History Fn002 JOG </pre>		Press the  key to return to the Utility Function Mode main menu.

<Note>

The alarm history can be cleared by executing the alarm history clearance (FnB0C with mode set at ALM History) described in 8.2.11 INDEXER Alarm Reset (FnB0C). The alarm history is not cleared by either resetting the alarms (FnB0C with mode set at ALM state) or by turning the SERVOPACK's control power supply off.

Troubleshooting

This chapter describes troubleshooting.

9.1	Troubleshooting	9-2
9.1.1	List of Alarms for Command Option Attachable Type SERVOPACKs	9-2
9.1.2	INDEXER Module Alarm Displays and Troubleshooting	9-9
9.2	Warning Displays	9-12
9.2.1	List of Warnings for Command Option Attachable Type SERVOPACKs	9-12
9.2.2	INDEXER Module Error Displays and Troubleshooting	9-14
9.3	Troubleshooting Malfunction Based on Operation and Conditions	9-19

9.1 Troubleshooting

When an alarm has been detected, the SERVOPACK stops the servomotor, and suspends motor operation.

When the SERVOPACK detects an alarm, the motor is stopped in accordance with the “alarm stopping method” described below, and the alarm status is displayed.

■ Status Displays

SERVOPACK Panel Display	The SERVOPACK alarm code is displayed.
LED	Green LED: Remains unlit Red LED: Remains lit
Digital Operator	The alarm code is displayed at the top left of the screen.
Response to the Alarm or Warning Read Command (ALM)	Alarm code
Response to the Most Recent Error Read Command (ERR)	No change
ALM Signal	Becomes active (photocoupler OFF).
/WARN Signal	No change

■ Alarm Stopping Method

Gr.1: The servomotor is stopped according to the settings in Pn001.0 if an alarm occurs. Pn001.0 is factory-set to stop the servomotor by applying the dynamic brake (DB).

Gr.2: The servomotor is stopped according to the setting in Pn00B.1 if an alarm occurs. Pn00B.1 is factory-set to stop the servomotor by setting the speed reference to “0.” The servomotor under torque control will always use the Gr.1 method to stop. By setting Pn00B.1 to 1, the servomotor stops using the same method as Gr.1. When coordinating a number of servomotors, use this alarm stop method to prevent machine damage that may result due to differences in the stop method.

■ Alarm Reset Capability

Available: Removing the cause of alarm and then executing the alarm reset can clear the alarm.

N/A: Executing the alarm reset cannot clear the alarm.

9.1.1 List of Alarms for Command Option Attachable Type SERVOPACKs

The SERVOPACK alarm list is shown below.

For details on the causes of SERVOPACK alarms and the corrective action to take in response to them, refer to the following manuals.

- *Σ-V Series User's Manual Design and Maintenance Rotational Motor/Command Option Attachable Type* (SIEP S800000 60).
- *Σ-V Series User's Manual Design and Maintenance Linear Motor/Command Option Attachable Type* (SIEP S800000 66).

Alarm Display	Alarm Name	Meaning	Servomotor Stop Method	Alarm Reset	Alarm Code Output		
					/ALO1	/ALO2	/ALO3
A.020	Parameter Checksum Error	The data of the parameter in the SERVOPACK is incorrect.	Gr.1	N/A	OFF (open)	OFF (open)	OFF (open)
A.021	Parameter Format Error	The data format of the parameter in the SERVOPACK is incorrect.	Gr.1	N/A			
A.022	System Checksum Error	The data of the parameter in the SERVOPACK is incorrect.	Gr.1	N/A			
A.030	Main Circuit Detector Error	Detection data for the main circuit is incorrect.	Gr.1	Available			
A.040	Parameter Setting Error	The parameter setting is outside the allowable setting range.	Gr.1	N/A			

(cont'd)

Alarm Display	Alarm Name	Meaning		Servomotor Stop Method	Alarm Reset	Alarm Code Output		
						/ALO1	/ALO2	/ALO3
A.041	Encoder Output Pulse Setting Error	Rotational motors	The encoder output pulse setting (pulse unit) (Pn212) is outside the allowable setting range or does not satisfy the setting conditions.	Gr.1	N/A	OFF (open)	OFF (open)	OFF (open)
		Linear motors	The encoder output resolution setting (Pn281) is outside the allowable setting range or does not satisfy the setting conditions.					
A.042	Parameter Combination Error	Combination of some parameters exceeds the setting range.		Gr.1	N/A			
A.044	Semi-closed/Fully-closed Loop Control Parameter Setting Error	The settings of the feedback option module and Pn00B.3, Pn002.3 do not match.		Gr.1	N/A			
A.04A	Parameter Setting Error 2	There is an error in settings of parameters reserved by the system.		Gr.1	N/A			
A.050	Combination Error	The SERVOPACK and the servomotor capacities do not match each other.		Gr.1	Available			
A.051	Unsupported Device Alarm	The unsupported device unit was connected.		Gr.1	N/A			
A.080	Linear Scale Pitch Setting Error	The setting of the linear scale pitch (Pn282) has not been changed from the default setting.		Gr.1	N/A			
A.0b0	Canceled Servo ON Command Alarm	The host controller reference was sent to turn the Servo ON after the Servo ON function was used with the utility function.		Gr.1	Available			
A.100	Overcurrent or Heat Sink Overheated	An overcurrent flowed through the IGBT. Heat sink of the SERVOPACK was overheated.		Gr.1	N/A	ON (close)	OFF (open)	OFF (open)
A.300	Regeneration Error	Regenerative circuit or regenerative resistor is faulty.		Gr.1	Available			
A.320	Regenerative Overload	Regenerative energy exceeds regenerative resistor capacity.		Gr.2	Available	ON (close)	ON (close)	OFF (open)
A.330	Main Circuit Power Supply Wiring Error	<ul style="list-style-type: none"> Setting of AC input/DC input is incorrect. Power supply wiring is incorrect. 		Gr.1	Available			
A.400	Overvoltage	Main circuit DC voltage is excessively high.		Gr.1	Available			
A.410	Undervoltage	Main circuit DC voltage is excessively low.		Gr.2	Available	OFF (open)	OFF (open)	ON (close)
A.450	Main-Circuit Capacitor Overvoltage	The capacitor of the main circuit has deteriorated or is faulty.		Gr.1	N/A			
A.510	Overspeed	The servomotor speed is over the maximum allowable speed.		Gr.1	Available			
A.511	Overspeed of Encoder Output Pulse Rate	Rotational motors	The set value of the encoder output pulse (Pn212) exceeds the speed limit.	Gr.1	Available	ON (close)	OFF (open)	ON (close)
		Linear motors	The set value of the encoder output resolution (Pn281) exceeds the speed limit.					
A.520	Vibration Alarm	Rotational motors	Vibration at the motor speed was detected.	Gr.1	Available			
		Linear motors	Vibration at the motor speed was detected.					
A.521	Autotuning Alarm	Vibration was detected while performing tuning-less function.		Gr.1	Available			
A.550	Maximum Speed Setting Error	The Pn385 setting is greater than the maximum speed.		Gr.1	Available			

9.1.1 List of Alarms for Command Option Attachable Type SERVOPACKs

(cont'd)

Alarm Display	Alarm Name	Meaning		Servomotor Stop Method	Alarm Reset	Alarm Code Output		
						/ALO1	/ALO2	/ALO3
A.710	Overload: High Load	Rotational motors	The motor was operating for several seconds to several tens of seconds under a torque largely exceeding ratings.	Gr.2	Available	ON (close)	ON (close)	ON (close)
		Linear motors	The linear servomotor was operating for several seconds to several tens of seconds under a force largely exceeding ratings.					
A.720	Overload: Low Load	Rotational motors	The motor was operating continuously under a torque largely exceeding ratings.	Gr.1	Available			
		Linear motors	The linear servomotor was operating continuously under a force largely exceeding ratings.					
A.730 A.731	Dynamic Brake Overload	Rotational motors	When the dynamic brake was applied, rotational energy exceeded the capacity of dynamic brake resistor.	Gr.1	Available			
		Linear motors	When the dynamic brake was applied, moving energy exceeded the capacity of dynamic brake resistor.					
A.740	Overload of Surge Current Limit Resistor	The main circuit power was frequently turned ON and OFF.		Gr.1	Available			
A.7A0	Heat Sink Overheated	The temperature of the SERVOPACK heat sink exceeded 100°C.		Gr.2	Available			
A.7AB	Built-in Fan in SERVOPACK Stopped	The fan inside the SERVOPACK stopped.		Gr.1	Available			
A.810	Encoder Backup Error	All the power supplies for the absolute encoder have failed and position data was cleared.		Gr.1	N/A			
A.820	Encoder Checksum Error	Rotational motors	The checksum results of encoder memory is incorrect.	Gr.1	N/A			
		Linear motors	The checksum results of linear scale memory is incorrect.					
A.830	Absolute Encoder Battery Error	The battery voltage is lower than the specified value after the control power supply is turned ON.		Gr.1	Available			
A.840	Encoder Data Error	Rotational motors	Data in the encoder is incorrect.	Gr.1	N/A			
		Linear motors	Data in the linear scale is incorrect.					
A.850	Encoder Overspeed	Rotational motors	The encoder was rotating at high speed when the power was turned ON.	Gr.1	N/A			
		Linear motors	The linear scale was operating at high speed when the power was turned ON.					
A.860	Encoder Overheated	Rotational motors	The internal temperature of encoder is too high.	Gr.1	N/A			
		Linear motors	The internal temperature of linear scale is too high.					
A.890	Encoder Scale Error	A linear scale fault occurred.		Gr.1	N/A			
A.891	Encoder Module Error	Linear scale is faulty.		Gr.1	N/A			
A.8A0*	External Encoder Error	External encoder is faulty.		Gr.1	Available			

* Alarm occurs when an Option Module for Fully-closed Loop Control is mounted.

(cont'd)

Alarm Display	Alarm Name		Meaning	Servomotor Stop Method	Alarm Reset	Alarm Code Output		
						/ALO1	/ALO2	/ALO3
A.8A1*	External Encoder Error of Module		Serial converter unit is faulty.	Gr.1	Available			
A.8A2*	External Encoder Error of Sensor (Incremental)		External encoder is faulty.	Gr.1	Available			
A.8A3*	External Encoder Error of Position (Absolute)		The external encoder position data is incorrect.	Gr.1	Available	OFF (open)	OFF (open)	OFF (open)
A.8A5*	Encoder Overspeed		The overspeed from the external encoder occurred.	Gr.1	Available			
A.8A6*	Encoder Overheated		The overheat from the external encoder occurred.	Gr.1	Available			
A.AEF	INDEXER Module Alarm		Some kind of alarm has occurred at the INDEXER Module.	Gr.1	Refer to 9.1.2	OFF (open)	ON (close)	ON (close)
A.b31	Current Detection Error 1 (Phase-U)		The current detection circuit for phase-U is faulty.	Gr.1	N/A			
A.b32	Current Detection Error 2 (Phase-V)		The current detection circuit for phase-V is faulty.	Gr.1	N/A			
A.b33	Current Detection Error 3 (Current detector)		The detection circuit for the current is faulty.	Gr.1	N/A			
A.bF0	System Alarm 0		“Internal program error 0” occurred in the SERVOPACK.	Gr.1	N/A	OFF (open)	OFF (open)	OFF (open)
A.bF1	System Alarm 1		“Internal program error 1” occurred in the SERVOPACK.	Gr.1	N/A			
A.bF2	System Alarm 2		“Internal program error 2” occurred in the SERVOPACK.	Gr.1	N/A			
A.bF3	System Alarm 3		“Internal program error 3” occurred in the SERVOPACK.	Gr.1	N/A			
A.bF4	System Alarm 4		“Internal program error 4” occurred in the SERVOPACK.	Gr.1	N/A			
A.C10	Servo Overrun Detected		The servomotor ran out of control.	Gr.1	Available			
A.C20	Phase Detection Error		The detection of the phase is incorrect.	Gr.1	N/A			
A.C21	Hall Sensor Error		The hall sensor is faulty.	Gr.1	N/A			
A.C22	Phase Information Disagreement		The phase information does not match.	Gr.1	N/A			
A.C50	Polarity Detection Error		The polarity detection failed.	Gr.1	N/A			
A.C51	Overtravel Detection at Polarity Detection		The overtravel signal was detected at polarity detection.	Gr.1	Available			
A.C52	Polarity Detection Uncompleted		The linear servomotor was turned ON under the condition of polarity detection uncompleted.	Gr.1	Available			
A.C53	Out of Range for Polarity Detection		The movement distance exceeded the set value of Pn48E during polarity detection.	Gr.1	N/A	ON (close)	OFF (open)	ON (close)
A.C54	Polarity Detection Error 2		The polarity detection failed.	Gr.1	N/A			
A.C80	Rotational motors	Absolute Encoder Clear Error and Multi-turn Limit Setting Error	The multi-turn for the absolute encoder was not properly cleared or set.	Gr.1	N/A			
	Linear motors	Absolute Encoder Clear Error	The data of the absolute linear scale was not properly cleared or set.					

* Alarm occurs when an Option Module for Fully-closed Loop Control is mounted.

9.1.1 List of Alarms for Command Option Attachable Type SERVOPACKs

(cont'd)

Alarm Display	Alarm Name	Meaning		Servomotor Stop Method	Alarm Reset	Alarm Code Output		
						/ALO1	/ALO2	/ALO3
A.C90	Encoder Communications Error	Rotational motors	Communications between the SERVOPACK and the encoder is not possible.	Gr.1	N/A	ON (close)	OFF (open)	ON (close)
		Linear motors	Communications between the SERVOPACK and the linear scale is not possible.					
A.C91	Encoder Communications Position Data Error	Rotational motors	An encoder position data calculation error occurred.	Gr.1	N/A			
		Linear motors	A linear scale position data calculation error occurred.					
A.C92	Encoder Communications Timer Error	Rotational motors	An error occurs in the communications timer between the encoder and the SERVOPACK.	Gr.1	N/A			
		Linear motors	An error occurs in the communications timer between the linear scale and the SERVOPACK.					
A.CA0	Encoder Parameter Error	Rotational motors	Encoder parameters are faulty.	Gr.1	N/A			
		Linear motors	Linear scale parameters are faulty.					
A.Cb0	Encoder Echoback Error	Rotational motors	Contents of communications with encoder is incorrect.	Gr.1	N/A			
		Linear motors	Contents of communications with linear scale is incorrect.					
A.CC0	Multi-turn Limit Disagreement	Different multi-turn limits have been set in the encoder and the SERVOPACK.		Gr.1	N/A			
A.CF1*	Feedback Option Module Communications Error (Reception error)	Reception from the feedback option module is faulty.		Gr.1	N/A			
A.CF2*	Feedback Option Module Communications Error (Timer stop)	Timer for communications with the feedback option module is faulty.		Gr.1	N/A			
A.d00	Position Error Pulse Overflow	Position error pulses exceeded the value set for parameter (Pn520) (Excessive Position Error Alarm Level).		Gr.1	Available			
A.d01	Position Error Pulse Overflow Alarm at Servo ON	Position error pulses accumulated too much.		Gr.1	Available			
A.d02	Position Error Pulse Overflow Alarm by Speed Limit at Servo ON	Rotational motors	After a position error pulse has been input, Pn529 limits the speed if the servo ON command is received. If Pn529 limits the speed in such a state, this alarm occurs when the position references are input and the number of position error pulses exceeds the value set for parameter Pn520 (Excessive Position Error Alarm Level).	Gr.2	Available			
		Linear motors	After a position error pulse has been input, Pn584 limits the speed if the servo ON command is received. If Pn584 limits the speed in such a state, this alarm occurs when the position references are input and the number of position error pulses exceeds the value set for parameter Pn520 (Excessive Position Error Alarm Level).					

* Alarm occurs when an Option Module for Fully-closed Loop Control is mounted.

(cont'd)

Alarm Display	Alarm Name	Meaning	Servomotor Stop Method	Alarm Reset	Alarm Code Output		
					/ALO1	/ALO2	/ALO3
A.d10*	Motor-load Position Error Pulse Overflow	Position error between motor and load is excessive when fully-closed position control is used.	Gr.2	Available	ON (close)	ON (close)	OFF (open)
A.d30	Position Data Overflow	The position feedback data exceeded ± 1879048192 .	Gr.1	N/A			
A.E00	Command Option Module IF Initialization Timeout Error	Communications initialization failed between the SERVOPACK and the command option module.	Gr.2	Available	OFF (open)	ON (close)	ON (close)
A.E02	Command Option Module IF Synchronization Error 1	An synchronization error occurred between the SERVOPACK and the command option module.	Gr.1	Available			
A.E03	Command Option Module IF Communications Data Error	An error occurred in the data of communications between the SERVOPACK and the command option module.	Gr.1	Available			
A.E40	Command Option Module IF Communications Setting Error	An error occurred in establishing communications (settings) between the SERVOPACK and the command option module.	Gr.2	Available			
A.E50	Command Option Module IF Synchronization Error 2	An error occurred in synchronization between the SERVOPACK and the command option module.	Gr.2	Available			
A.E51	Command Option Module IF Synchronization Establishment Error	An error occurred in establishing communications between the SERVOPACK and the command option module.	Gr.2	Available			
A.E60	Command Option Module IF Data Communications Error	An error occurred in communications between the SERVOPACK and the command option module.	Gr.2	Available			
A.E61	Command Option Module IF Synchronization Error 3	There was a change in timing of synchronization between the SERVOPACK and the command option module.	Gr.2	Available			
A.E70	Command Option Module Detection Failure	Detection of the command option module failed.	Gr.1	N/A			
A.E71	Safety Option Module Detection Failure	Detection of the safety option module failed.	Gr.1	N/A			
A.E72*	Feedback Option Module Detection Failure	Detection of the feedback option module failed.	Gr.1	N/A			
A.E73	Unsupported Command Option Module	An unsupported command option module was connected.	Gr.1	N/A			
A.E74	Unsupported Safety Option Module	An unsupported safety option module was connected.	Gr.1	N/A			
A.E75*	Unsupported Feedback Option Module	An unsupported feedback option module was connected.	Gr.1	N/A			
A.E80	Command Option Module Unmatched Error	The command option module was replaced with a different model.	Gr.1	N/A			
A.EA2	Alarm in Current Communications between the INDEXER Module and SERVOPACK 1	An error has occurred in communications between the INDEXER Module and SERVOPACK during operation.	Gr.1	Available			
A.EA3	Alarm in Current Communications between the INDEXER Module and SERVOPACK 2	An error has occurred in communications between the INDEXER Module and SERVOPACK during operation.	Gr.1	Available			

* Alarm occurs when an Option Module for Fully-closed Loop Control is mounted.

9.1.1 List of Alarms for Command Option Attachable Type SERVOPACKs

(cont'd)

Alarm Display	Alarm Name	Meaning	Servomotor Stop Method	Alarm Reset	Alarm Code Output		
					/ALO1	/ALO2	/ALO3
A.Eb1	Safety Device Signal Input Timing Error	There is an error in the timing of the safety function input signal.	Gr.1	N/A	OFF (open)	ON (close)	ON (close)
A.ED1	Command Option Module IF Command Timeout Error	Processing of reference from the command option module was not completed.	Gr.2	Available			
A.F10	Main Circuit Cable Open Phase	With the main power supply ON, voltage was low for more than 1 second in phase-R, -S or -T.	Gr.2	Available	OFF (open)	ON (close)	OFF (open)
CPF00	Digital Operator Transmission Error 1	Digital operator (JUSP-OP05A) fails to communicate with the SERVOPACK (e.g., CPU error).	–	N/A	Invalid		
CPF01	Digital Operator Transmission Error 2		–	N/A			
A.--	Not an error	Normal operation status	–	–	OFF (open)	OFF (open)	OFF (open)

9.1.2 INDEXER Module Alarm Displays and Troubleshooting

The INDEXER Module alarm list and the corresponding corrective actions are shown below.

Serial Command Negative Response	Panel Display	Alarm Name	Meaning	Corrective Action	Servomotor Stop Method	Alarm Reset
–	A.□□□	SERVOPACK Alarm Activation Alarm	A SERVOPACK alarm occurred.	–	Refer to 9.1.1.	Refer to 9.1.1.
E12A	A.AEF	Firmware Execution Alarm	The firmware processing time was too long.	<ul style="list-style-type: none"> Upgrade the firmware version. Reduce the number of functions being used. 	Gr.1	N/A
E13A	A.AEF	Firmware Version Unmatched	The SERVOPACK does not supported this function, because the software version do not match.*1	<ul style="list-style-type: none"> Upgrade the SERVOPACK software version. Use the SERVOPACK that supports the corresponding function. Use the SERVOPACK with the function set disabled. 	Gr.1	N/A
E14A	A.AEF	Parameter Checksum Alarm (Detected only when control power supply is turned ON.)	Incorrect or corrupted parameters are stored in EEPROM. (This alarm can occur if the control power supply is turned OFF while the parameters are being initialized or changed.)	<ul style="list-style-type: none"> Initialize the parameters with the PRMINIT command or FnB0B*2. If the problem is not solved, correct the parameters. 	Gr.1	N/A
E15A	A.AEF	Parameter Version Unmatched (Detected only when the control power supply is turned ON.)	The combination of the firmware version number and the parameter version number is wrong.	<ul style="list-style-type: none"> Change the firmware version. Change the parameter version to match the firmware version. 	Gr.1	N/A
E16A	A.AEF	Parameter Out-of-range Alarm (Detected only when control power supply is turned ON.)	The moving method is set to a rotary method (PnB20 = 1, 2, or 3), but the home position set in PnB25 exceeds the software limits set in PnB21 and PnB23.	Correct the home position setting (PnB25) or the software limits (PnB21 and PnB23).	Gr.1	N/A

*1. The following function cannot be used with the SERVOPACK software version 0016 or earlier.

Function Name	SERVOPACK Software Version Number		Related Parameter	Remarks
	0016 or earlier	0017 or later		
Alarm Code Output Signals (/ALO1, /ALO2, /ALO3)	Not supported	Supported	PnB51	For the SERVOPACK whose software version number is 0016 or earlier, set PnB51 to 0 (PnB51 = 0).

*2. This function is available for the following software versions.
 INDEXER module: Version 3 or later
 SERVOPACK: Version 001B or later.

(cont'd)

Serial Command Negative Response	Panel Display	Alarm Name	Meaning	Corrective Action	Servomotor Stop Method	Alarm Reset
E17A	A.E00	Initial Communication Alarm between INDEXER Module and SERVOPACK (Detected only when control power supply is turned ON.)	The INDEXER Module failed in initialization of communications with the SERVOPACK when the control power was turned ON.	Take steps to reduce noise in the system such as improving frame ground.	Gr. 1	N/A
	A.AEF		The SERVOPACK is not compatible with the INDEXER Module.	<ul style="list-style-type: none"> Upgrade the SERVOPACK's software version. Replace the SERVOPACK with a SERVOPACK that is compatible with the INDEXER Module. 		
	A.C90 or A.040		<ul style="list-style-type: none"> The INDEXER Module failed in parameter calculation during initial communications with the SERVOPACK when the control power was turned ON. This can happen in the following cases: <ul style="list-style-type: none"> When a parameter has been changed while the encoder is not connected When a parameter has been changed during occurrence of A.040 alarm 	<ul style="list-style-type: none"> Connect the encoder and then change the parameter. Cancel the A.040 alarm and then change the parameter. (If the alarm display is other than A.E00, it can be reset by turning the power OFF and back ON.) 		
E18A	A.EA2, A.EA3	Communication Alarm between INDEXER Module and SERVOPACK	An error occurred in communications between the INDEXER Module and SERVOPACK during operation.	Take steps to reduce noise in the system such as improving frame ground.	Gr. 1	Available
E19A	A.AEF	Program Table Checksum Alarm (Detected only when control power supply is turned ON.)	The program table stored in flash memory was not recorded properly. (This alarm can occur if the control power supply is turned OFF while the program table is being saved or initialized.)	<ul style="list-style-type: none"> Initialize the program table with the PGMINIT command or FnB06.*2 If the problem is not solved, correct the program table. 	Gr. 1	Available*3
E1AA	A.AEF	Program Table Version Unmatched (Detected only when the control power is ON.)	The combination of the firmware version and the program table version is wrong.	<ul style="list-style-type: none"> Change the firmware version. Change the program table version to match the firmware version. 	Gr. 1	Available*3
E1BA	A.AEF	Program Out-of-range Alarm (Detected only when control power supply is turned ON.)	A value set in the program table is not within the allowed setting range.	<ul style="list-style-type: none"> Change the firmware version. Change the program table version to match the firmware version. 	Gr. 1	Available*3

*2. This function is available for the following software versions.

INDEXER module: Version 3 or later
SERVOPACK: Version 001B or later.

*3. These alarms can be reset, but a Canceled Program Table Error (E44E) will occur the next time you attempt to start program table operation, so program table operation will not be possible.

(cont'd)

Serial Command Negative Response	Panel Display	Alarm Name	Meaning	Corrective Action	Servomotor Stop Method	Alarm Reset
E1CA	A.AEF	Zone Table Checksum Alarm (Detected only when control power supply is turned ON.)	The zone table stored in flash memory was not recorded properly. (This alarm can occur if the control power supply is turned OFF while the zone table is being saved or initialized.)	<ul style="list-style-type: none"> Initialize the zone table with the ZONEINIT command or FnB07.*2 If the problem is not solved, correct the zone table. 	Gr.1	Available *4
E1DA	A.AEF	ZONE Table Version Unmatched (Detected only when the control power supply is turned ON.)	The combination of the firmware version and the ZONE table version is wrong.	<ul style="list-style-type: none"> Change the firmware version. Change the ZONE table version to match the firmware version. 	Gr.1	Available *4
E1EA	A.AEF	Zone Table Out-of-range Alarm (Detected only when control power supply is turned ON.)	A value set in the zone table is not within the allowed setting range.	<ul style="list-style-type: none"> Change the firmware version. Change the ZONE table version to match the firmware version. 	Gr.1	Available *4
E1FA	A.AEF	JOG Speed Table Checksum Alarm (Detected only when control power supply is turned ON.)	The JOG speed table stored in flash memory was not recorded properly. (This alarm can occur if the control power supply is turned OFF while the JOG speed table is being saved or initialized.)	<ul style="list-style-type: none"> Initialize the JOG speed table with the JSPDINIT command or FnB08.*2 If the problem is not solved, correct the JOG speed table. 	Gr.1	Available *5
E21A	A.AEF	JOG Speed Table Version Unmatched (Detected only when the control power supply is turned ON.)	The combination of the firmware version and the JOG speed table version is wrong	<ul style="list-style-type: none"> Change the firmware version. Change the JOG speed table version to match the firmware version. 	Gr.1	Available *5
E22A	A.AEF	JOG Speed Table Out-of-range Alarm (Detected only when control power supply is turned ON.)	A value set in the JOG speed table is not within the allowed setting range.	<ul style="list-style-type: none"> Change the firmware version. Change the JOG speed table version to match the firmware version. 	Gr.1	Available *5
E23A	A.AEF	Insufficient Registration Distance Alarm	The registration distance was shorter than the deceleration distance when the /RGRT signal went ON to start registration operation. (The current position will exceed the position specified by registration.)	<p>Either increase the registration distance or reduce the deceleration distance (increase the deceleration rate).</p> <p>The registration distance can be set by executing the RDST command or changing the RDST parameter in the program table.</p> <p>The deceleration rate can be changed by executing the DEC command or changing parameter PnB2B.</p>	Gr.1	Available

*2. This function is available for the following software versions.

INDEXER module: Version 3 or later

SERVOPACK: Version 001B or later.

*4. These alarms can be reset, but it is possible that the zone signals (POUT0 to POUT7) will be output incorrectly. When using the zone table, correct the zone table without resetting.

*5. These alarms can be reset, but a Canceled JOG Speed Table Error (E46E) will occur the next time you attempt to start JOG speed table operation, so JOG speed table operation will not be possible.

9.2 Warning Displays

When a warning has been detected, the SERVOPACK displays the warning status as shown below, and continues motor operation.

■ Status Displays

SERVOPACK Panel Display	The SERVOPACK's warning code is displayed.
LED	Red LED: Flashing
Digital Operator	When a warning occurs, the warning code is displayed at the top left of the screen.
Response to the Alarm or Warning Read Command (ALM)	Warning code
Response to the Most Recent Error Read Command (ERR)	No change
ALM Signal	No change
/WARN Signal	Becomes active.

9.2.1 List of Warnings for Command Option Attachable Type SERVOPACKs

The relation between warning displays and warning code outputs are shown below.

For details on the causes of warnings and the corrective action to take in response to them, refer to the following manuals.

- *Σ-V Series User's Manual Design and Maintenance Rotational Motor/Command Option Attachable Type* (SIEP S800000 60).
- *Σ-V Series User's Manual Design and Maintenance Linear Motor/Command Option Attachable Type* (SIEP S800000 66).

Warning Display	Warning Name	Meaning	Warning Code Output		
			/ALO1	/ALO2	/ALO3
A.900	Position Error Pulse Overflow	Position error pulse exceeded the parameter settings (Pn520×Pn51E/100).	OFF (open)	OFF (open)	OFF (open)
A.901	Position Error Pulse Overflow Alarm at Servo ON	When the servo turns ON, the position error pulses exceeded the parameter setting (Pn526×Pn528/100).			
A.910	Overload	This warning occurs before the overload alarms (A.710 or A.720) occur. If the warning is ignored and operation continues, an overload alarm may occur.	ON (close)	OFF (open)	OFF (open)
A.911	Vibration	Abnormal vibration at the motor speed was detected. The detection level is the same as A.520. Set whether to output an alarm or warning by "Vibration Detection Switch" of Pn310.			
A.920	Regenerative Overload	This warning occurs before the regenerative overload alarm (A.320) occurs. If the warning is ignored and operation continues, a regenerative overload alarm may occur.	OFF (open)	ON (close)	OFF (open)
A.921	Dynamic Brake Overload	This warning occurs before the dynamic brake overload alarm (A.731) occurs. If the warning is ignored and operation continues, a dynamic brake overload alarm may occur.			
A.930	Absolute Encoder Battery Error	This warning occurs when the absolute encoder battery voltage is lowered.	ON (close)	ON (close)	OFF (open)

(cont'd)

Warning Display	Warning Name	Meaning	Warning Code Output		
			/ALO1	/ALO2	/ALO3
A.94A	Command Option Module IF Data Setting Warning 1	This warning occurs when there is an error in a parameter number sent to the SERVOPACK from the host controller or command option module.	OFF (open)	OFF (open)	ON (close)
A.94B	Command Option Module IF Data Setting Warning 2	This warning occurs when out-of-range data is sent to the SERVOPACK from the host controller or command option module.			
A.94C	Command Option Module IF Data Setting Warning 3	This warning occurs when there is an error in the parameter data sent to the SERVOPACK from the host controller or command option module.			
A.94D	Command Option Module IF Data Setting Warning 4	This warning occurs when there is an error in the data size sent to the SERVOPACK from the host controller or command option module.			
A.94E	Command Option Module IF Data Setting Warning 5	This warning occurs when there is an error in the latch mode settings sent to the SERVOPACK from the host controller or command option module.			
A.95A	Command Option Module IF Command Warning 1	This warning occurs when the host controller or command option module outputs an operating command when the operation execution conditions in the SERVOPACK have not been met.	ON (close)	OFF (open)	ON (close)
A.95B	Command Option Module IF Command Warning 2	This warning occurs when there is an error in the command output from the command option module to the SERVOPACK.			
A.95D	Command Option Module IF Command Warning 4	This warning occurs when a latch command is output from the command option module to the SERVOPACK during latch operation.			
A.95E	Command Option Module IF Command Warning 5	This warning occurs when an unallowed command combination is output to the SERVOPACK from the command option module.			
A.95F	Command Option Module IF Command Warning 6	This warning occurs when there is an error in the command output to the SERVOPACK from the command option module.			
A.960	Command Option Module IF Communications Warning	This warning occurs when an error occurred in communications between the SERVOPACK and command option module.	OFF (open)	ON (close)	ON (close)
A.971	Undervoltage	This warning occurs before the undervoltage alarm (A.410) occurs. If the warning is ignored and operation continues, an undervoltage alarm may occur.	ON (close)	ON (close)	ON (close)
A.A9F	Error	Some kind of error has occurred at the INDEXER Module. Refer to 9.2.2 <i>INDEXER Module Error Displays and Troubleshooting</i> .	ON (close)	OFF (open)	OFF (open)

Note 1. Set Pn001.3 = 1 (Outputs both Alarm Codes and Warning Codes) to output warning codes.

2. If Pn008.2 = 1 (Does not detect warning) is selected, warnings other than the undervoltage warning (A.971) will not be detected.

9.2.2 INDEXER Module Error Displays and Troubleshooting

Negative responses (error responses) to input signals, serial commands, or operations from the Digital Operator are known as errors.

When an error occurs, the display and signal output will remain for 2 seconds.

The servo will not be turned OFF when an error occurs.

■ Status Displays

SERVOPACK Panel Display	“A.A9F” is displayed for 2 seconds.
LED	The red LED flashes for 2 seconds.
Digital Operator	“A.A9F” is displayed for 2 seconds at the top left of the screen.
Response to the Alarm or Warning Read Command (ALM)	No change
Response to the Most Recent Error Read Command (ERR)	Error code (the most recent (closest) error code)
ALM Signal	No change
/WARN Signal	Becomes active for 2 seconds.

The INDEXER Module error displays and the corrective actions are shown below.

Serial Command Negative Response	Panel Display	Error Name	Meaning	Corrective Action
E41E	A.A9F	Program Table Save Failure Error	<p>While writing data to the flash memory, a failure occurred during one of the following operation.</p> <ul style="list-style-type: none"> • While saving a program table by using a PGMSTORE command • While saving a program table by using FnB03* • While initializing a program table by using a PGMINIT command • While initializing a program table by using FnB06* 	Repair the hardware.
E42E	A.A9F	Zone Table Save Failure Error	<p>While writing data to the flash memory, a failure occurred during one of the following operation.</p> <ul style="list-style-type: none"> • While saving a zone table by using a ZONESTORE command • While saving a zone table by using FnB04* • While initializing a zone table by using a ZONEINIT command • While initializing a zone table by using FnB07* 	Repair the hardware.
E43E	A.A9F	JOG Speed Table Save Failure Error	<p>While writing data to the flash memory, a failure occurred during one of the following operation.</p> <ul style="list-style-type: none"> • While saving a JOG speed table by using a JSPDSTORE command • While saving a JOG speed table by using FnB05* • While initializing a JOG speed table by using a JSPDINIT command • While initializing a JOG speed table by using FnB08* 	Repair the hardware.

* This function is available for the following software versions.
 INDEXER module: Version 3 or later
 SERVOPACK: Version 001B or later.

(cont'd)

Serial Command Negative Response	Panel Display	Error Name	Meaning	Corrective Action
E44E	A.A9F	Canceled Program Table Error	There was a request to start program table operation even though an E19A or E1BA alarm occurred when the control power supply was turned ON.	Eliminate the cause of the alarm.
E46E	A.A9F	Canceled JOG Speed Table Error	There was a request to start JOG speed table operation even though an E1FA or E22A alarm occurred when the control power supply was turned ON.	Eliminate the cause of the alarm.
E47E	A.A9F	Serial Communications Receiving Buffer Overflow Error	There was an overflow in the reception buffer used for serial commands. <ul style="list-style-type: none"> An error will occur if too many serial commands are sent consecutively without waiting for the responses. (Normally, the reception buffer will not overflow if there is command/response handshaking.) When an overflow has occurred, error code E47E will be returned and all of the data that has accumulated in the reception buffer will be discarded. 	Wait for a response to be received before sending the next command. The reception buffer can contain up to 100 commands.
E48E	A.A9F	Serial Communications Parity Error	A parity check error occurred with the serial command. <ul style="list-style-type: none"> This error will occur if even parity is not being used. The command that caused this error will be discarded and no response will be returned. There will be no response, but the /WARN output and LED indicators will indicate that an error has occurred. 	<ul style="list-style-type: none"> Check the serial communications protocol (PnB00) and bit rate (PnB01) settings. Check the wiring. If noise may be causing the problem, take steps to reduce noise such as using communications cables with ferrite cores.
E49E	A.A9F	Serial Communications Framing Error	A stop bit detection error occurred with the serial command. <ul style="list-style-type: none"> The command that caused this error will be discarded and no response will be returned. There will be no response, but the /WARN output and LED indicators will indicate that an error has occurred. 	<ul style="list-style-type: none"> Check the serial communications protocol (PnB00) and bit rate (PnB01) settings. Check the wiring. If noise may be causing the problem, take steps to reduce noise such as using communications cables with ferrite cores.
E4AE	A.A9F	Serial Communications Overrun Error	Serial command reception failed. <ul style="list-style-type: none"> The hardware's reception buffer was overwritten with the subsequent data. (Normally, data is read before it is overwritten, so this error does not occur.) 	Repair the hardware.
E4BE	A.A9F	Moving Disabled Error due to P-OT	Travel in the forward direction was requested when P-OT was in effect. (Forward movement is disabled when P-OT (forward overtravel) is in effect.)	<ul style="list-style-type: none"> When P-OT is being used, move to a position where the P-OT is not in effect. When P-OT is not being used, disable P-OT in the parameter (PnB0F = 3).
E4CE	A.A9F	Moving Disabled Error due to N-OT	Travel in the reverse direction was requested when N-OT was in effect. (Reverse movement is disabled when N-OT (reverse overtravel) is in effect.)	<ul style="list-style-type: none"> When N-OT is being used, move to a position where the N-OT is not in effect. When N-OT is not being used, disable N-OT in the parameter (PnB10 = 3).

(cont'd)

Serial Command Negative Response	Panel Display	Error Name	Meaning	Corrective Action
E4DE	A.A9F	Moving Disabled Error due to P-LS	The specified target position exceeds the position reference of forward software limit set in PnB21.	<ul style="list-style-type: none"> • Check the target position specification. • Check the forward software limit in PnB21. • Check the moving mode (rotary or linear) set in PnB20. • If software limits are not being used, either select a rotary moving mode in PnB20 or disable the software limits by setting PnB21 = PnB23 = 0.
E4EE	A.A9F	Moving Disabled Error due to N-LS	The specified target position exceeds the position reference of reverse software limit set in PnB23.	<ul style="list-style-type: none"> • Check the target position specification. • Check the reverse software limit in PnB23. • Check the moving mode (rotary or linear) set in PnB20. • If software limits are not being used, either select a rotary moving mode in PnB20 or disable the software limits by setting PnB21 = PnB23 = 0.
E4FE	A.A9F	Position Reference Out-of-range Error	The moving method is set to rotary (PnB20 = 1, 2, or 3) and the target position specification exceeds the position reference limits in PnB21 and PnB23.	<ul style="list-style-type: none"> • Check the target position specification. • Check the positioning range set with PnB21 and PnB23. • Check the moving method (rotary or linear) set in PnB20.
E51E	A.A9F	Target Position Unspecified Error	Even though the target position was not specified even once, there was a request by the ST command to start positioning or a request by the RS command to start registration positioning.	Specify a target position with a command such as the POS command, STnnnnnnnn command, or RSnnnnnnnn command.
E52E	A.A9F	Registration Distance Unspecified Error	Even though the registration distance was not specified even once, there was a request by the RS command to start registration positioning.	Specify a registration distance with the RDST command.
E53E	A.A9F	Move Reference Duplication Error	There was a new move reference requested even though the system was already moving in a positioning or other travelling operation.	<ul style="list-style-type: none"> • Send the next move reference request only after the current movement is completed (Position reference distribution is completed). • A movement can be interrupted or canceled with the HOLD or SKIP commands. Also, STOP can be specified in the target position specification (POS) with the program table.

(cont'd)

Serial Command Negative Response	Panel Display	Error Name	Meaning	Corrective Action
E54E	A.A9F	Servo ON Incomplete Error	<p>The servo is not ON.</p> <ul style="list-style-type: none"> There was a positioning request or other move reference request in servo OFF status. The servo went OFF during program table operation. (Program table operation will be interrupted while just the step that was being executed is canceled (If LOOP ≠ 1, the first LOOP is canceled.)) 	<p>Send the move reference request only after turning the servo ON by turning ON the /S-ON signal, setting PnB0E = 2 so that the /S-ON signal is always ON, or executing the SVON command. There are two possibilities.</p> <ul style="list-style-type: none"> The program can be canceled with the /PGMRES signal or PGMRES command. The servo can be turned ON and the program can be restarted with the /START-STOP signal or the START command.
E55E	A.A9F	Servo ON Failure Error	<p>The servo could not be turned ON within 2 s after turning ON the /S-ON signal or executing the SVON command.</p> <ul style="list-style-type: none"> The motor is rotating during servo ON execution. The main power supply went OFF during servo ON execution. Hard wire base block status (HWBB status) Error E5BE will occur if there was an alarm when the servo ON request was sent using the SVON command. Error E5CE will occur if the main power supply was OFF when the servo ON request was sent. 	<ul style="list-style-type: none"> Turn the servo ON when the motor is stopped. Check the main power supply. Turn ON signals /HWBB1, /HWBB2. After that, temporarily establish the servo OFF status by turning the /S-ON signal OFF or sending the SVOFF command, then turn the servo ON again.
E56E	A.A9F	Undefined Serial Command Error	<ul style="list-style-type: none"> There was a syntax error in the serial command. There was a number in the serial command longer than 8 digits or 10 digits. 	Check the serial command's character string.
E57E	A.A9F	Address Out-of-range Error	The specified address was incorrect for a parameter, program table, zone table, JOG speed table, alarm history, or monitor read/write command.	Check the address.
E58E	A.A9F	Data Out-of-range Error	The specified setting was incorrect in a parameter or program table write command.	Check the setting.
E59E	A.A9F	Communication Failure Error between INDEXER Module and SERVOPACK	Communications between the INDEXER Module and the SERVOPACK have failed.	Check the version of the SERVOPACK.
E5AE	A.A9F	Execution Disabled while Servo ON Error	<p>Some of the utility functions, such as parameter initialization, has been requested while still in the servo ON status. For safety, the following functions cannot be executed in the servo ON status.</p> <ul style="list-style-type: none"> Serial commands: Parameter initialization, absolute encoder reset, motor current zero adjustment SigmaWin+: Parameter initialization 	Execute these functions after turning the servo OFF.
E5BE	A.A9F	Execution Disabled while Alarm Activated Error	Servo ON was requested (the SVON command was executed) while there was an alarm.	Turn the servo ON after eliminating the cause of the alarm and clearing the alarm.
E5CE	A.A9F	Execution Disabled while Main Power OFF Error	Servo ON was requested (the SVON command was executed) while the main power supply was OFF.	Turn the servo ON after turning ON the main power supply.

(cont'd)

Serial Command Negative Response	Panel Display	Error Name	Meaning	Corrective Action
E5DE	A.A9F	Homing Method Unspecified Error	The homing method is not specified. <ul style="list-style-type: none"> Homing Start was requested (/HOME signal was turned ON or ZRN command was executed) without setting the homing method. 	Specify the homing method in PnB31.
E5EE	A.A9F	Execution Disabled during Program Table Operation Error	<ul style="list-style-type: none"> There was a request to execute a process that is not allowed during program table operation while program table operation was in progress or on hold. There was an attempt to change the program table while program table operation was in progress or on hold. There was a request to start positioning by a serial command while program table operation was in progress or on hold. 	Request execution of the process again after cancelling program table operation by turning the /PGMRES signal ON.
E5FE	A.A9F	Session Conflict Error	There was a request that could not be executed at the same time as the function that was being executed. Example: There was a request to start program table operation while the program table was being initialized.	Execute the operation again after the execution of the current function is completed.
E61E	A.A9F	Encoder Mismatch Error	There was a request that was incompatible with the connected encoder. Examples: <ul style="list-style-type: none"> An Absolute Encoder Reset (ABSPGRES command) was requested when an incremental encoder is connected. Homing Start was requested (/HOME signal was turned ON or ZRN command was executed) when an absolute encoder is connected. (An absolute encoder can be used as an incremental encoder if parameter Pn002.2 = 1.)	Check the encoder.
E62E	A.A9F	No A.CC0 Alarm Occurred Error	A Multi-turn Limit Setting (MLTLIMSET command) was requested even though alarm A.CC0 has not occurred. (Alarm A.CC0 indicates that Pn205 does not match the setting in the encoder after the multi-turn limit setting in Pn205 was changed and the control power supply was turned OFF and ON.)	Use the Multi-turn Limit Setting operation to adjust the setting in the encoder to match Pn205 only after alarm A.CC0 has occurred.
E63E	A.A9F	Continuous Stop Execution Disabled Error	An attempt was made to execute a continuous stop under conditions where it could not be executed. Examples: <ul style="list-style-type: none"> The coordinates have been set to linear moving method. The immediately-preceding table target position is not \pmINFINITE. The immediately-preceding table target position is \pmINFINITE, but the registration distance is set. A value other than 1 has been set for the execution count. 	Execute a continuous stop under conditions where it can be executed.

9.3 Troubleshooting Malfunction Based on Operation and Conditions

Troubleshooting for the malfunctions based on operation and condition is provided in this section.

Be sure to turn OFF the servo system before troubleshooting items outlined in bold in the table.

(1) Rotational Servomotors

Problem	Probable Cause	Investigative Actions	Corrective Actions
Servomotor Does Not Start	The control power supply is not ON.	Check the voltage between control power supply terminals.	Correct the wiring so that the control power supply comes ON.
	The main circuit power supply is not ON.	Check the voltage between main circuit power supply terminals.	Correct the wiring so that the control power supply comes ON.
	Wiring of I/O signal connector CN1 is faulty or disconnected.	Check if the connector CN1 is properly inserted and connected.	Correct the connector CN1 connection.
	Servomotor or encoder wiring is disconnected.	Check the wiring.	Correct the wiring.
	The servomotor is overloaded.	Run under no load and check the load status.	Reduce load or replace with larger capacity servomotor.
	Settings for input signals PnB03 to PnB12 are incorrect.	Check settings of input signals PnB03 to PnB12.	Correct the settings of input signals PnB03 to PnB12.
	A servo ON command was not input.	Check the command sent from the host controller.	Send a servo ON command.
	The forward run prohibited (P-OT) and reverse run prohibited (N-OT) input signals are turned OFF.	Check P-OT or N-OT input signal.	Turn P-OT or N-OT input signal ON.
	The current position of the servomotor is outside the software limit setting range.	Check the error at the INDEXER Module.	Check the motor position and software limit setting (PnB21, PnB23), then move the servomotor into the software limit setting range.
	There is no position reference, or it is incorrect.	Check the error at the INDEXER Module.	Set the program table correctly.
	The safety input signal (/HWBB1 or /HWBB2) remains OFF.	Check the /HWBB1 or /HWBB2 input signal.	Set the /HWBB1 or /HWBB2 input signal to ON. When not using the safety function, mount the safety function jumper connector (provided as an accessory) on the CN8.
A SERVOPACK fault occurred.	–	Replace the SERVOPACK.	
Servomotor Moves Instantaneously, and then Stops	Servomotor wiring is incorrect.	Check the servomotor wiring.	Correct the wiring.
	Encoder wiring is incorrect.	Check the encoder wiring.	Correct the wiring.
Servomotor Speed Unstable	Wiring connection to servomotor is defective.	Check connections of main circuit cable (phases-U, -V, and -W) and encoder connectors.	Tighten any loose terminals or connectors.
Servomotor Rotates without Reference Input	A SERVOPACK fault occurred.	–	Replace the SERVOPACK.
Dynamic Brake Does Not Operate	Setting for parameter Pn001.0 is incorrect.	Check the setting of parameter Pn001.0.	Correct the parameter setting.
	Dynamic brake resistor is disconnected.	Check if excessive moment of inertia, motor overspeed, or Dynamic Brake frequently activated. If moment of inertia exceeds, motor overspeeds, or Dynamic Brake is frequently activated, Dynamic Brake resistor may be disconnected.	Replace the SERVOPACK, and reduce the load to avoid disconnection.

(cont'd)

Problem	Probable Cause	Investigative Actions	Corrective Actions
Dynamic Brake Does Not Operate (cont'd)	Dynamic brake drive circuit fault	–	There is a defective component in the dynamic brake circuit. Replace the SERVOPACK.
Abnormal Noise from Servomotor	The servomotor largely vibrated during execution of tuning-less function (factory setting).	Check the servomotor speed waveform.	Reduce the load so that the moment of inertia ratio becomes within the allowable value, or increase the load level or lower the tuning level for the tuning-less level setting (Fn200).
	Mounting is not secured.	Check the mounting status of the servomotor.	Tighten the mounting screws.
		Check if there is misalignment of couplings.	Align the couplings.
		Check if there are unbalanced couplings.	Balance the couplings.
	Bearings are defective.	Check for noise and vibration around the bearings.	Replace the servomotor.
	Vibration source at the driven machine	Check for any foreign matter, damage, or deformations on the machinery's movable parts.	Contact the machine manufacturer.
	Noise interference due to incorrect input/output signal cable specifications	The I/O signal cables must be tinned annealed copper shielded twisted-pair or shielded multi-core twisted-pair cables with a core of 0.12 mm ² min.	Use the specified I/O signal wires.
	Noise interference due to length of input/output signal cable	Check the length of the input/output cable.	The input/output cable must be no longer than 3 m.
	Noise interference due to incorrect encoder cable specifications	The encoder cable must be tinned annealed copper shielded twisted-pair or shielded multi-core twisted-pair cables with a core of 0.12 mm ² min.	Use the specified encoder cable.
	Noise interference due to length of encoder cable wiring	Check the length of the encoder cable.	The encoder cable must be no longer than 20 m.
	Noise interference due to damaged encoder cable	Check if the encoder cable is bent or if its sheath is damaged.	Replace the encoder cable and modify the encoder cable layout.
	Excessive noise to the encoder cable	Check if the encoder cable is bundled with high-current line or near a high-current line.	Correct the encoder cable layout so that no surge from high-current lines is applied.
	FG potential varies because of influence of machines such as welders at the servomotor.	Check if the machines are correctly grounded.	Ground machines correctly, and prevent diversion to the FG at the PG side.
	SERVOPACK pulse counting error due to noise interference	Check if there is noise interference on the input/output signal line from the encoder.	Take measures against noise in the encoder wiring.
Excessive vibration and shock to the encoder	Check if vibration from the machine occurred or servomotor installation is incorrect (mounting surface accuracy, fixing, alignment, etc.).	Reduce vibration from the machine, or secure the servomotor installation.	
An encoder fault occurred.	–	Replace the servomotor.	
Servomotor Vibrates at Frequency of Approx. 200 to 400 Hz	Unbalanced servo gains	Check to see if the servo gains have been correctly adjusted.	Execute the advanced autotuning.
	Speed loop gain value (Pn100) too high	Check the speed loop gain value (Pn100). Factory setting: K _v = 40.0 Hz	Reduce the speed loop gain value (Pn100).
	Position loop gain value (Pn102) too high	Check the position loop gain value (Pn102). Factory setting: K _p = 40.0/s	Reduce the position loop gain value (Pn102).

(cont'd)

Problem	Probable Cause	Investigative Actions	Corrective Actions
Servomotor Vibrates at Frequency of Approx. 200 to 400 Hz (cont'd)	Incorrect speed loop integral time constant value (Pn101)	Check the speed loop integral time constant (Pn101). Factory setting: $T_i = 20.0$ ms	Correct the speed loop integral time constant value (Pn101).
	Incorrect moment of inertia ratio value (Pn103)	Check the moment of inertia ratio value (Pn103).	Correct the moment of inertia ratio value (Pn103).
High Rotation Speed Overshoot on Starting and Stopping	Unbalanced servo gains	Check to see if the servo gains have been correctly adjusted.	Execute the advanced autotuning.
	Speed loop gain value (Pn100) too high	Check the speed loop gain value (Pn100). Factory setting: $K_v = 40.0$ Hz	Reduce the speed loop gain value (Pn100).
	Position loop gain value (Pn102) too high	Check the position loop gain value (Pn102). Factory setting: $K_p = 40.0/s$	Reduce the position loop gain value (Pn102).
	Incorrect speed loop integral time constant value (Pn101)	Check the speed loop integral time constant value (Pn101). Factory setting: $T_i = 20.0$ ms	Correct the speed loop integral time constant value (Pn101).
	Incorrect moment of inertia ratio value (Pn103)	Check the moment of inertia ratio value (Pn103).	Correct the moment of inertia ratio value (Pn103).
Absolute Encoder Position Difference Error (The position saved in the host controller when the power was turned OFF is different from the position when the power is next turned ON.)	Noise interference due to improper encoder cable specifications	The encoder cable must be tinned annealed copper shielded twisted-pair or shielded multi-core twisted-pair cables with a core of 0.12 mm^2 min.	Use the specified encoder cable.
	Noise interference due to length of encoder cable	Check the encoder cable length.	The encoder cable must be no longer than 20 m.
	Noise interference due to damaged encoder cable	Check if the encoder cable is bent or if its sheath is damaged.	Replace the encoder cable and correct the encoder cable layout.
	Excessive noise interference at the encoder cable	Check if the encoder cable is bundled with a high-current line or near high-current line.	Correct the encoder cable layout so that no surge from high-current lines is applied.
	FG potential varies because of influence of machines such as welders at the servomotor.	Check if the machines are correctly grounded.	Ground machines correctly, and prevent diversion to the FG at the PG side.
	SERVOPACK pulse counting error due to noise interference	Check if there is noise interference on the input/output signal line from the encoder.	Take measures against noise in the encoder wiring.
	Excessive vibration and shock to the encoder	Check if vibration from the machine occurred or servomotor installation is incorrect (mounting surface accuracy, fixing, alignment, etc.).	Reduce vibration from the machine, or secure the servomotor installation.
	An encoder fault occurred.	–	Replace the servomotor.
	A SERVOPACK fault occurred. (The pulse count does not change.)	–	Replace the SERVOPACK.
	Host controller multi-turn data reading error	Check the error detection section at the host controller.	–
Check if the host controller is executing data parity checks.		–	Execute a multi-turn data parity check.
Check noise in the input/output signal line between the SERVOPACK and the host controller.		–	Take measures against noise, and again execute a multi-turn data parity check.

(cont'd)

Problem	Probable Cause	Investigative Actions	Corrective Actions
Overtravel (OT)	Forward or reverse run prohibited signal is input.	Check the external power supply (+24 V) voltage for the input signal.	Correct the external power supply (+24 V) voltage.
		Check if the overtravel limit switch operates properly.	Correct the overtravel limit switch.
		Check if the overtravel limit switch is wired correctly.	Correct the overtravel limit switch wiring.
		Check the settings for PnB0F and PnB10.	Set the parameters correctly.
	Forward or reverse run prohibited signal is malfunctioning.	Check the fluctuation of external power supply (+24 V) voltage for the input signal.	Stabilize the external power supply (+24 V) voltage.
		Check if the overtravel limit switch operates correctly.	Stabilize the operation of the overtravel limit switch.
		Check if the overtravel limit switch wiring is correct. (Check for damaged cables or loose screws.)	Correct the overtravel limit switch wiring.
	Incorrect servomotor stop method selection	Check Pn001.0 and PnB1F when the servomotor power is OFF.	Select a servomotor stop method other than "coast to stop."
Check Pn001.0 and PnB1F in torque control.		Select a servomotor stop method other than "coast to stop."	
Improper Position to Stop by Overtravel (OT) Signal	Improper limit switch position and dog length	–	Install the limit switch at the appropriate position.
	The overtravel limit switch position is too close for the coasting distance.	–	Install the overtravel limit switch at the appropriate position.

(cont'd)

Problem	Probable Cause	Investigative Actions	Corrective Actions
Position Error (Without Alarm)	Noise interference due to improper encoder cable specifications	The encoder cable must be tinned annealed copper shielded twisted-pair or shielded multi-core twisted-pair cable with a core of 0.12 mm ² min.	Use the specified encoder cable.
	Noise interference due to length of encoder cable	Check the encoder cable length.	The encoder cable must be no longer than 20 m.
	Noise influence due to damaged encoder cable	Check if the encoder cable is bent or if its sheath is damaged.	Replace the encoder cable and correct the encoder cable layout.
	Excessive noise interference to encoder cable	Check if the encoder cable is bundled with a high-current line or near a high-current line.	Correct the encoder cable layout so that no surge from high-current lines is applied.
	FG potential varies because of influence of machines such as welders at the servomotor.	Check if the machines are correctly grounded.	Ground machines correctly, and prevent diversion to the FG at the PG side.
	SERVOPACK pulse counting error due to noise interference	Check if there is noise interference on the I/O signal line from the encoder.	Take measures against noise in the encoder wiring.
	Excessive vibration and shock to the encoder	Check if vibration from the machine occurred or servomotor installation is incorrect (mounting surface accuracy, fixing, alignment, etc.).	Reduce vibration from the machine, or secure the servomotor installation.
	Unsecured coupling between machine and servomotor	Check if a position error occurs at the coupling between machine and servomotor.	Secure the coupling between the machine and servomotor.
	Noise interference due to improper I/O signal cable specifications	The I/O signal cable must be tinned annealed copper shielded twisted-pair or shielded multi-core twisted-pair cables with a core of 0.12 mm ² min.	Use the specified I/O signal cable.
	Noise interference due to length of I/O signal cable	Check the I/O signal cable length.	The I/O signal cable must be no longer than 3 m.
	An encoder fault occurred. (The pulse count does not change.)	–	Replace the servomotor.
A SERVOPACK fault occurred.	–	Replace the SERVOPACK.	
Servomotor Overheated	Ambient temperature too high	Measure the servomotor ambient temperature.	Lower the ambient temperature to 40°C or less.
	Servomotor surface dirty	Visually check the surface.	Clean dust and oil from the surface.
	Servomotor overloaded	Check the load status with monitor.	If overloaded, reduce load or replace with larger capacity SERVOPACK and servomotor.

(2) Linear Servomotors

Problem	Probable Cause	Investigative Actions	Corrective Actions
Linear Servomotor Does Not Start When Using JOG Operation or Host Controller Reference.	The control power supply is not ON.	Check voltage between control power supply terminals.	Correct the control power circuit.
	The main circuit power supply is not ON.	Check the voltage between power supply terminals.	Correct the power circuit.
	Wrong wiring or disconnection of I/O signal connector CN1	Check if the connector CN1 is properly inserted and connected.	Correct the connector CN1 connection.
	Linear servomotor cable or linear connection cables disconnected.	Check the wiring.	Correct the wiring.
	The linear servomotor is overloaded.	Run under no load and check the load status.	Reduce load or replace with larger capacity linear servomotor.
	Settings for input signals PnB03 to PnB12 are incorrect.	Check settings of input signals PnB03 to PnB12.	Correct the settings of input signals PnB03 to PnB12.
	A servo ON command was not input.	Check the command sent from the host controller.	Send a servo ON command.
	The forward run prohibited (P-OT) and reverse run prohibited (N-OT) input signals are turned OFF.	Check P-OT or N-OT input signal.	Turn P-OT or N-OT input signal ON.
	The current position of the servomotor is outside the software limit setting range.	Check the error at the INDEXER Module.	Check the motor position and software limit setting (PnB21, PnB23), then move the servomotor into the software limit setting range.
	There is not position reference, or it is incorrect.	Check the error at the INDEXER Module.	Set the program table correctly.
	The polarity detection is not executed.	Check the parameter Pn080.	Correct the setting of Pn080.
		Check the command sent from the host controller.	When using an incremental linear scale, send the servo ON command. When using an absolute linear scale, execute polarity detection (Fn080).
	The safety input signal (/HWBB1 or /HWBB2) remains OFF.	Check the /HWBB1 or /HWBB2 input signal.	Set the /HWBB1 or /HWBB2 input signal to ON. When not using the safety function, mount the safety function jumper connector (provided as an accessory) on the CN8.
A SERVOPACK fault occurred.	–	Replace the SERVOPACK.	
Linear Servomotor Moves Instantaneously, and then Stops	Linear servomotor wiring is incorrect.	Check the linear servomotor wiring.	Correct the linear servomotor wiring.
	Serial converter unit wiring is incorrect.	Check the serial converter unit wiring.	Correct the serial converter unit wiring.
	Linear scale wiring is incorrect.	Check the linear scale wiring.	Correct the linear scale wiring.
	Linear scale pitch (Pn282) is incorrect.	Check the setting of Pn282.	Correct the setting of Pn282.
	Linear scale counting up direction and motor moving coil forward direction do not agree.	Check the directions.	Change the setting of Pn080.1 (Motor Phase Selection). Match the linear scale direction and moving coil direction.
	Polarity detection is not performed correctly.	Check if the value of Un004 (Electric Angle 2, angle from polarity origin) at an arbitrary position is between ± 10 degrees.	Correct the settings for the polarity detection related parameter.
Linear Servomotor Speed Unstable	Wiring connection to linear servomotor is defective.	Check connection of power lead (phases U, V, and W) and the connectors of serial converter unit connection cables.	Tighten any loose terminals or connectors.

(cont'd)

Problem	Probable Cause	Investigative Actions	Corrective Actions
Linear Servomotor Moves Without Reference Input	A SERVOPACK fault occurred.	–	Replace the SERVOPACK.
	Linear scale counting up direction and motor moving coil forward direction do not agree.	Check the directions.	Change the setting of Pn080.1 (Motor Phase Selection). Match the linear scale direction and moving coil direction.
	Polarity detection is not performed correctly.	Check if the value of Un004 (Electric Angle 2, angle from polarity origin) at an arbitrary position is between ± 10 degrees.	Correct the settings for the polarity detection related parameter.
DB (dynamic brake) Does Not Operate	Improper setting of parameter Pn001.0	Check the setting of parameter Pn001.0.	Correct the setting of parameter Pn001.0.
	DB resistor disconnected	Check if excessive mass, motor overspeed, or DB frequent activation has occurred.	Replace the SERVOPACK, and reconsider the load.
	DB drive circuit fault	–	DB circuit parts are faulty. Replace the SERVOPACK.
Abnormal Noise from Linear Servomotor	The linear servomotor largely vibrated during execution of tuning-less function (factory setting).	Check the motor speed waveform.	Reduce the load so that the mass ratio becomes within the allowable value, or increase the load level or lower the rigidity level for the tuning-less level setting (Fn200).
	Mounting not secured	Check if there are any loosen mounting screws.	Tighten the mounting screws.
	Vibration source on the driven machine	Check the machine movable section for foreign matter, damage or deformity.	Contact the machine manufacturer.
	Noise interference due to incorrect I/O signal cable specifications	The specifications of I/O signal cables must be: Shielded twisted-pair or shielded multi-core twisted-pair wire with core 0.12 mm ² min. and tinned annealed copper twisted wire.	Use the specified I/O signal cables.
	Noise interference due to long distance of I/O signal cable	Check the I/O signal cable length.	Shorten the I/O signal cable length to 3 m or less.
	Noise interference due to incorrect specifications of linear scale connection cables.	The specifications of cable for connecting serial converter unit must be: Shielded twisted-pair or shielded multi-core twisted-pair wire with core 0.12 mm ² min. and tinned annealed copper twisted wire.	Use the specified linear scale connection cables.
	Noise interference because the linear scale connection cables is too long	Check the length of the linear scale connection cables.	The maximum length of linear scale connection cables: 20 m for the cable for connecting a serial converter unit 15 m for the cable for connecting a linear scale/hall sensor

(cont'd)

Problem	Probable Cause	Investigative Actions	Corrective Actions
Abnormal Noise from Linear Servomotor (cont'd)	Noise interference because the linear scale connection cables are damaged	Check the linear scale connection cables to see if they are not damaged or bent.	Replace the linear scale connection cables, and reconsider the layout of the linear scale connection cables.
	Excessive noise to the linear scale connection cables.	Check if the linear scale connection cables are not bundled with high-current line or not near the high-current line.	Modify the cable layout so that no surge from high-current line is applied to the linear scale connection cables.
	FG electrical potential varies by influence of such machines on the linear servomotor side as welders.	Check if the machine is correctly grounded.	Ground the machine separately from linear scale side FG.
	SERVOPACK pulse counting error due to noise	Check if there is noise interference on the I/O signal cable from the serial converter unit.	Take measure against noise for the serial converter unit wiring.
	Excessive vibration and shock to the serial converter unit	Check if vibration from the machine occurred or serial converter unit installation is incorrect. (Mounting surface accuracy, or fixing.)	Reduce vibration from the machine, or correct the serial converter unit installation.
	A serial converter unit fault occurred.	–	Replace the serial converter unit.
	A linear scale fault occurred.	–	Replace the linear scale.
Linear Servomotor Vibrates at about 200 to 400 Hz	Unbalanced servo gains	Check to see if the servo gains have been correctly adjusted.	Execute the advanced autotuning.
	Speed loop gain value (Pn100) is too high.	Check the speed loop gain value (Pn100). Factory setting: $K_v = 40.0$ Hz	Reduce the speed loop gain (Pn100).
	Position loop gain value (Pn102) is too high.	Check the position loop gain value (Pn102). Factory setting: $K_p = 40.0/s$	Reduce the position loop gain (Pn102).
	Incorrect speed loop integral time constant (Pn101) setting	Check the speed loop integral time constant (Pn101) setting. Factory setting: $T_i = 20.0$ ms	Correct the speed loop integral time constant (Pn101) setting.
	Incorrect mass ratio (Pn103) setting	Check the mass ratio (Pn103) setting.	Correct the mass ratio (Pn103) setting.
High Speed Overshoot on Starting and Stopping	Unbalanced servo gains	Check to see if the servo gains have been correctly adjusted.	Execute the advanced autotuning.
	Speed loop gain value (Pn100) is too high.	Check the speed loop gain value (Pn100). Factory setting: $K_v = 40.0$ Hz	Reduce the speed loop gain (Pn100).
	Position loop gain value (Pn102) is too high.	Check the position loop gain value (Pn102). Factory setting: $K_p = 40.0/s$	Reduce the position loop gain (Pn102).
	Incorrect speed loop integral time constant (Pn101) setting	Check the speed loop integral time constant (Pn101) setting. Factory setting: $T_i = 20.0$ ms	Correct the speed loop integral time constant (Pn101) setting.
	Incorrect mass ratio (Pn103) setting	Check the mass ratio (Pn103) setting.	Correct the mass ratio (Pn103) setting.
	The force reference is saturated.	Check the force reference waveform.	Use the mode switch function.
	The force limit (Pn483, Pn484) is set to the initial value.	Initial value of force limit: Pn483 = 30% Pn484 = 30%	Set Pn483 and Pn484 (Force Limit) to an appropriate value.

(cont'd)

Problem	Probable Cause	Investigative Actions	Corrective Actions
Linear Scale Position Difference Error (The position saved in the host controller when the power was turned OFF is different from the position when the power is next turned ON.)	Noise interference due to improper linear scale connection cable specifications	The specifications of linear scale connection cables must be: Shielded twisted-pair or shielded multi-core twisted-pair wire with core 0.12 mm ² min. and tinned annealed copper twisted wire.	Use the specified linear scale connection cables.
	Noise interference due to length of linear scale connection cables	Check the length of linear scale connection cables.	The maximum length of linear scale connection cables: 20 m for the cable for connecting a serial converter unit 15 m for the cable for connecting a linear scale/hall sensor
	Noise interference due to damaged linear scale connection cables	Check if any of the linear scale connection cables is bent or if its sheaths are damaged.	Replace the linear scale connection cables and correct their layout.
	Excessive noise interference at the linear scale connection cables	Check if any of the linear scale connection cables is bundled with a high-current line or near high-current line.	Correct the linear scale connection cable layout so that no surge from high-current lines is applied.
	FG potential varies because of influence of machines such as welders at the servomotor.	Check if the machines are correctly grounded.	Ground machines correctly, and prevent diversion to the FG at the linear scale side.
	SERVOPACK pulse counting error due to noise interference	Check if there is noise interference on the input/output signal line from the serial converter unit.	Take measures against noise in the serial converter unit wiring.
	Excessive vibration and shock to the serial converter unit	Check if vibration from the machine occurred or the serial converter unit installation is incorrect (mounting surface accuracy and fixing).	Reduce vibration from the machine, or secure the serial converter unit installation.
	A serial converter unit fault occurred.	–	Replace the serial converter unit.
	A linear scale fault occurred.	–	Replace the linear scale.
	A SERVOPACK fault occurred.	–	Replace the SERVOPACK.
Host controller serial data reading error	Check the error detection section at the host controller.	Correct the error detection section of the host controller.	
	Check if the host controller is executing data parity checks.	Execute a serial data parity check.	
	Check for noise in the input/output signal line between the SERVOPACK and the host controller.	Take measures against noise, and again execute a serial data parity check.	
Overtravel (OT)	Forward or reverse run prohibited signal is input.	Check if the voltage of input signal external power supply (+24 V) is correct.	Correct external power supply (+24 V) voltage.
		Check if the overtravel limit switch operates properly.	Correct the overtravel limit switch.
		Check if the overtravel limit switch is connected correctly.	Correct the overtravel limit switch wiring.
	Check the settings for PnB0F and PnB10.	Set the parameters correctly.	
	Forward or reverse run prohibited signal is malfunctioning.	Check the fluctuation of the input signal external power supply (+24 V) voltage.	Stabilize the external power supply (+24 V) voltage.
		Check if the overtravel limit switch operates correctly.	Stabilize the operation of the overtravel limit switch.
Check if the overtravel limit switch wiring is correct. (check for damaged cables or loosen screws.)		Correct the overtravel limit switch wiring.	

(cont'd)

Problem	Probable Cause	Investigative Actions	Corrective Actions
Overtravel (OT) (cont'd)	Incorrect linear servomotor stop method selection	Check Pn001.0 and Pn001.1 when the linear servomotor power is OFF.	Select a linear servomotor stop method other than "coast to stop."
		Check Pn001.0 and Pn001.1 when in force control.	Select a linear servomotor stop method other than "coast to stop."
Improper Position to Stop by Overtravel (OT) Signal	Improper limit switch position and dog length	—	Install the limit switch at the appropriate position.
	The overtravel limit switch position is too short for the coasting distance.	—	Install the overtravel limit switch at the appropriate position.
Position Error (without alarm)	Noise interference due to improper specifications of the linear scale connection cables.	The specifications of the linear scale connection cables must be: Shielded twisted-pair or shielded multi-core twisted-pair wire with core 0.12 mm ² min. and tinned annealed copper twisted wire.	Use the linear scale connection cables with the specified specifications.
	Noise interference because the length of the linear scale connection cables is too long.	Check the length of the linear scale connection cables.	The maximum length of the linear scale connection cables: 20 m for the cable for connecting a serial converter unit 15 m for the cable for connecting a linear a linear scale/hall sensor.
	Noise influence due to damaged linear scale connection cables	Check the linear scale connection cables to see if any of them is bent or its sheath is damaged.	If the cable is damaged, replace it and correct the cable layout.
	Excessive noise interference to the linear scale connection cables	Check if the any of the linear scale connection cables is bundled with a high-current line or near high-current line.	Change the layout of the linear scale connection cables so that no surge voltage is applied.
	FG electrical potential varies by influence of such machines on the linear servomotor side as welders.	Check if the machine is correctly grounded.	Ground the machine separately from linear scale side FG.
	SERVOPACK pulse counting error due to noise	Check if the I/O signal cable from the serial converter unit is influenced by noise.	Take a measure against noise for the serial converter unit wiring.
	Excessive vibration and shock to the serial converter unit	Check if machine vibration occurred or serial converter unit mounting such as mounting surface precision, fixing is incorrect.	Reduce the machine vibration or mount the serial converter unit securely.
	Noise interference due to improper I/O signal cable specifications	The specifications of the I/O signal cable must be: Shielded twisted-pair or shielded multi-core twisted-pair wire with core 0.12 mm ² min. and tinned annealed copper twisted wire.	Use I/O signal cable with the specified specifications.
	Noise interference due to length of I/O signal cable	Check the I/O signal cable length.	The I/O signal cable length must be less than 3 m.
	A serial converter unit fault occurred.	—	Replace the serial converter unit
	A linear scale fault occurred.	—	Replace the linear servomotor.
A SERVOPACK fault occurred.	—	Replace the SERVOPACK.	

(cont'd)

Problem	Probable Cause	Investigative Actions	Corrective Actions
Servomotor Overheated	Ambient operating temperature is too high.	Measure the linear servomotor ambient operating temperature.	Reduce the ambient operating temperature to 40°C max.
	Linear servomotor surface is dirty.	Check visually.	Clean dust and oil from linear servomotor surface.
	Linear servomotor overloaded	Check the load status with monitor.	If overloaded, reduce load or replace with larger capacity SERVOPACK and linear servomotor.
	Polarity detection is not performed correctly.	Check if the value of Un004 (Electric Angle 2) at an arbitrary position is between ± 10 degrees.	Correct the settings for the polarity detection related parameter.

10

Appendix

This chapter presents the parameters, monitor mode, utility functions and serial command list.

10.1	Parameter List for INDEXER Module	10-2
10.2	Parameter List for Command Option Attachable Type SERVOPACKs	10-10
10.3	Monitor Modes	10-27
10.4	Utility Functions	10-28
10.5	Alphabetical List of Serial Commands	10-30
10.6	Parameter Equivalence List for INDEXER Modules for SGD SERVOPACKs and INDEXER Modules for SGD SERVOPACKs	10-33

10.1 Parameter List for INDEXER Module

The following table shows the INDEXER Module's parameters.

In this section, the word "open" or "close" shown in parentheses in parameter descriptions indicates that the contact is open or closed.

Parameter No.	Name	Setting Range	Setting Unit	Factory Setting	When Enabled	Reference
PnB00	Serial Communication Protocol	0 to 9	–	1	After restart	7.2.3
PnB01	Bit rate	0 to 2	–	0	After restart	7.2.3
PnB02	Response "OK"	0 to 1	–	1	Immediately	7.2.3
PnB03	/MODE 0/1	0 to 3	–	0	After restart	6.1.1, 6.4.1

(cont'd)

Parameter No.	Name	Setting Range	Setting Unit	Factory Setting	When Enabled	Reference																	
PnB04	/START-STOP; /HOME	0 to 3	–	0	After restart	6.1.2, 6.4.2																	
		<table border="1"> <thead> <tr> <th rowspan="2">Setting</th> <th colspan="2">Meaning</th> </tr> <tr> <th>Mode 0</th> <th>Mode 1</th> </tr> </thead> <tbody> <tr> <td>0</td> <td>Starts program table operation when /START-STOP signal is ON (close). Stops program table operation when /START-STOP signal is OFF (open).</td> <td>Starts homing when input signal is ON (close).</td> </tr> <tr> <td>1</td> <td>Starts program table operation when /START-STOP signal is OFF (open). Stops program table operation when /START-STOP signal is ON (close).</td> <td>Starts homing when input signal is OFF (open).</td> </tr> <tr> <td>2, 3</td> <td>Does not start program table operation.</td> <td>Does not start homing.</td> </tr> </tbody> </table>					Setting	Meaning		Mode 0	Mode 1	0	Starts program table operation when /START-STOP signal is ON (close). Stops program table operation when /START-STOP signal is OFF (open).	Starts homing when input signal is ON (close).	1	Starts program table operation when /START-STOP signal is OFF (open). Stops program table operation when /START-STOP signal is ON (close).	Starts homing when input signal is OFF (open).	2, 3	Does not start program table operation.	Does not start homing.			
	Setting	Meaning																					
		Mode 0	Mode 1																				
0	Starts program table operation when /START-STOP signal is ON (close). Stops program table operation when /START-STOP signal is OFF (open).	Starts homing when input signal is ON (close).																					
1	Starts program table operation when /START-STOP signal is OFF (open). Stops program table operation when /START-STOP signal is ON (close).	Starts homing when input signal is OFF (open).																					
2, 3	Does not start program table operation.	Does not start homing.																					
PnB05	/PGMRES; /JOGP	0 to 3	–	0	After restart	6.1.2, 6.4.2																	
		<table border="1"> <thead> <tr> <th rowspan="2">Setting</th> <th colspan="2">Meaning</th> </tr> <tr> <th>Mode 0</th> <th>Mode 1</th> </tr> </thead> <tbody> <tr> <td>0</td> <td>Resets program table operation by switching /PGMRES signal from OFF (open) to ON (close). Program table operation is canceled.</td> <td>Executes JOG operation in the forward direction when input signal is ON (close).</td> </tr> <tr> <td>1</td> <td>Resets program table operation by switching /PGMRES signal from ON (close) to OFF (open). Program table operation is canceled.</td> <td>Executes JOG operation in the forward direction when input signal is OFF (open).</td> </tr> <tr> <td>2, 3</td> <td>Does not reset program table operation.</td> <td>Does not execute JOG operation.</td> </tr> </tbody> </table>					Setting	Meaning		Mode 0	Mode 1	0	Resets program table operation by switching /PGMRES signal from OFF (open) to ON (close). Program table operation is canceled.	Executes JOG operation in the forward direction when input signal is ON (close).	1	Resets program table operation by switching /PGMRES signal from ON (close) to OFF (open). Program table operation is canceled.	Executes JOG operation in the forward direction when input signal is OFF (open).	2, 3	Does not reset program table operation.	Does not execute JOG operation.			
	Setting	Meaning																					
		Mode 0	Mode 1																				
0	Resets program table operation by switching /PGMRES signal from OFF (open) to ON (close). Program table operation is canceled.	Executes JOG operation in the forward direction when input signal is ON (close).																					
1	Resets program table operation by switching /PGMRES signal from ON (close) to OFF (open). Program table operation is canceled.	Executes JOG operation in the forward direction when input signal is OFF (open).																					
2, 3	Does not reset program table operation.	Does not execute JOG operation.																					
PnB06	/SEL0; /JOGN	0 to 3	–	0	After restart	6.1.2, 6.4.2																	
		<table border="1"> <thead> <tr> <th rowspan="2">Setting</th> <th colspan="2">Meaning</th> </tr> <tr> <th>Mode 0</th> <th>Mode 1</th> </tr> </thead> <tbody> <tr> <td>0</td> <td>When input signal is ON (close), program table selection signal /SEL0 becomes active.</td> <td>Executes JOG operation in the reverse direction when input signal is ON (close).</td> </tr> <tr> <td>1</td> <td>When input signal is OFF (open), program table selection signal /SEL0 becomes active.</td> <td>Executes JOG operation in the reverse direction when input signal is OFF (open).</td> </tr> <tr> <td>2</td> <td>Program table selection signal /SEL0 is always active.</td> <td>Does not execute JOG operation.</td> </tr> <tr> <td>3</td> <td>Program table selection signal /SEL0 is always inactive.</td> <td>Does not execute JOG operation.</td> </tr> </tbody> </table>					Setting	Meaning		Mode 0	Mode 1	0	When input signal is ON (close), program table selection signal /SEL0 becomes active.	Executes JOG operation in the reverse direction when input signal is ON (close).	1	When input signal is OFF (open), program table selection signal /SEL0 becomes active.	Executes JOG operation in the reverse direction when input signal is OFF (open).	2	Program table selection signal /SEL0 is always active.	Does not execute JOG operation.	3	Program table selection signal /SEL0 is always inactive.	Does not execute JOG operation.
	Setting	Meaning																					
		Mode 0	Mode 1																				
	0	When input signal is ON (close), program table selection signal /SEL0 becomes active.	Executes JOG operation in the reverse direction when input signal is ON (close).																				
1	When input signal is OFF (open), program table selection signal /SEL0 becomes active.	Executes JOG operation in the reverse direction when input signal is OFF (open).																					
2	Program table selection signal /SEL0 is always active.	Does not execute JOG operation.																					
3	Program table selection signal /SEL0 is always inactive.	Does not execute JOG operation.																					
PnB07	/SEL1; /JOG0	0 to 3	–	0	After restart	6.1.2, 6.4.2																	
		<table border="1"> <thead> <tr> <th rowspan="2">Setting</th> <th colspan="2">Meaning</th> </tr> <tr> <th>Mode 0</th> <th>Mode 1</th> </tr> </thead> <tbody> <tr> <td>0</td> <td>When input signal is ON (close), program table selection signal /SEL1 becomes active.</td> <td>When input signal is ON (close), JOG speed table selection signal /JOG0 becomes active.</td> </tr> <tr> <td>1</td> <td>When input signal is OFF (open), program table selection signal /SEL1 becomes active.</td> <td>When input signal is OFF (open), JOG speed table selection signal /JOG0 becomes active.</td> </tr> <tr> <td>2</td> <td>Program table selection signal /SEL1 is always active.</td> <td>JOG speed table selection signal /JOG0 is always active.</td> </tr> <tr> <td>3</td> <td>Program table selection signal /SEL1 is always inactive.</td> <td>JOG speed table selection signal /JOG0 is always inactive.</td> </tr> </tbody> </table>					Setting	Meaning		Mode 0	Mode 1	0	When input signal is ON (close), program table selection signal /SEL1 becomes active.	When input signal is ON (close), JOG speed table selection signal /JOG0 becomes active.	1	When input signal is OFF (open), program table selection signal /SEL1 becomes active.	When input signal is OFF (open), JOG speed table selection signal /JOG0 becomes active.	2	Program table selection signal /SEL1 is always active.	JOG speed table selection signal /JOG0 is always active.	3	Program table selection signal /SEL1 is always inactive.	JOG speed table selection signal /JOG0 is always inactive.
	Setting	Meaning																					
		Mode 0	Mode 1																				
	0	When input signal is ON (close), program table selection signal /SEL1 becomes active.	When input signal is ON (close), JOG speed table selection signal /JOG0 becomes active.																				
1	When input signal is OFF (open), program table selection signal /SEL1 becomes active.	When input signal is OFF (open), JOG speed table selection signal /JOG0 becomes active.																					
2	Program table selection signal /SEL1 is always active.	JOG speed table selection signal /JOG0 is always active.																					
3	Program table selection signal /SEL1 is always inactive.	JOG speed table selection signal /JOG0 is always inactive.																					

(cont'd)

Parameter No.	Name	Setting Range	Setting Unit	Factory Setting	When Enabled	Reference																	
PnB08	/SEL2; /JOG1	0 to 3	–	0	After restart	6.1.2, 6.4.2																	
		<table border="1"> <thead> <tr> <th rowspan="2">Setting</th> <th colspan="2">Meaning</th> </tr> <tr> <th>Mode 0</th> <th>Mode 1</th> </tr> </thead> <tbody> <tr> <td>0</td> <td>When input signal is ON (close), program table selection signal /SEL2 becomes active.</td> <td>When input signal is ON (close), JOG speed table selection signal /JOG1 becomes active.</td> </tr> <tr> <td>1</td> <td>When input signal is OFF (open), program table selection signal /SEL2 becomes active.</td> <td>When input signal is OFF (open), JOG speed table selection signal /JOG1 becomes active.</td> </tr> <tr> <td>2</td> <td>Program table selection signal /SEL2 is always active.</td> <td>JOG speed table selection signal /JOG1 is always active.</td> </tr> <tr> <td>3</td> <td>Program table selection signal /SEL2 is always inactive.</td> <td>JOG speed table selection signal /JOG1 is always inactive.</td> </tr> </tbody> </table>					Setting	Meaning		Mode 0	Mode 1	0	When input signal is ON (close), program table selection signal /SEL2 becomes active.	When input signal is ON (close), JOG speed table selection signal /JOG1 becomes active.	1	When input signal is OFF (open), program table selection signal /SEL2 becomes active.	When input signal is OFF (open), JOG speed table selection signal /JOG1 becomes active.	2	Program table selection signal /SEL2 is always active.	JOG speed table selection signal /JOG1 is always active.	3	Program table selection signal /SEL2 is always inactive.	JOG speed table selection signal /JOG1 is always inactive.
	Setting	Meaning																					
		Mode 0	Mode 1																				
	0	When input signal is ON (close), program table selection signal /SEL2 becomes active.	When input signal is ON (close), JOG speed table selection signal /JOG1 becomes active.																				
	1	When input signal is OFF (open), program table selection signal /SEL2 becomes active.	When input signal is OFF (open), JOG speed table selection signal /JOG1 becomes active.																				
2	Program table selection signal /SEL2 is always active.	JOG speed table selection signal /JOG1 is always active.																					
3	Program table selection signal /SEL2 is always inactive.	JOG speed table selection signal /JOG1 is always inactive.																					
PnB09	/SEL3; /JOG2	0 to 3	–	0	After restart	6.1.2, 6.4.2																	
		<table border="1"> <thead> <tr> <th rowspan="2">Setting</th> <th colspan="2">Meaning</th> </tr> <tr> <th>Mode 0</th> <th>Mode 1</th> </tr> </thead> <tbody> <tr> <td>0</td> <td>When input signal is ON (close), program table selection signal /SEL3 becomes active.</td> <td>When input signal is ON (close), JOG speed table selection signal /JOG2 becomes active.</td> </tr> <tr> <td>1</td> <td>When input signal is OFF (open), program table selection signal /SEL3 becomes active.</td> <td>When input signal is OFF (open), JOG speed table selection signal /JOG2 becomes active.</td> </tr> <tr> <td>2</td> <td>Program table selection signal /SEL3 is always active.</td> <td>JOG speed table selection signal /JOG2 is always active.</td> </tr> <tr> <td>3</td> <td>Program table selection signal /SEL3 is always inactive.</td> <td>JOG speed table selection signal /JOG2 is always inactive.</td> </tr> </tbody> </table>					Setting	Meaning		Mode 0	Mode 1	0	When input signal is ON (close), program table selection signal /SEL3 becomes active.	When input signal is ON (close), JOG speed table selection signal /JOG2 becomes active.	1	When input signal is OFF (open), program table selection signal /SEL3 becomes active.	When input signal is OFF (open), JOG speed table selection signal /JOG2 becomes active.	2	Program table selection signal /SEL3 is always active.	JOG speed table selection signal /JOG2 is always active.	3	Program table selection signal /SEL3 is always inactive.	JOG speed table selection signal /JOG2 is always inactive.
	Setting	Meaning																					
		Mode 0	Mode 1																				
	0	When input signal is ON (close), program table selection signal /SEL3 becomes active.	When input signal is ON (close), JOG speed table selection signal /JOG2 becomes active.																				
	1	When input signal is OFF (open), program table selection signal /SEL3 becomes active.	When input signal is OFF (open), JOG speed table selection signal /JOG2 becomes active.																				
2	Program table selection signal /SEL3 is always active.	JOG speed table selection signal /JOG2 is always active.																					
3	Program table selection signal /SEL3 is always inactive.	JOG speed table selection signal /JOG2 is always inactive.																					
PnB0A	/SEL4; /JOG3	0 to 3	–	0	After restart	6.1.2, 6.4.2																	
		<table border="1"> <thead> <tr> <th rowspan="2">Setting</th> <th colspan="2">Meaning</th> </tr> <tr> <th>Mode 0</th> <th>Mode 1</th> </tr> </thead> <tbody> <tr> <td>0</td> <td>When input signal is ON (close), program table selection signal /SEL4 becomes active.</td> <td>When input signal is ON (close), JOG speed table selection signal /JOG3 becomes active.</td> </tr> <tr> <td>1</td> <td>When input signal is OFF (open), program table selection signal /SEL4 becomes active.</td> <td>When input signal is OFF (open), JOG speed table selection signal /JOG3 becomes active.</td> </tr> <tr> <td>2</td> <td>Program table selection signal /SEL4 is always active.</td> <td>JOG speed table selection signal /JOG3 is always active.</td> </tr> <tr> <td>3</td> <td>Program table selection signal /SEL4 is always inactive.</td> <td>JOG speed table selection signal /JOG3 is always inactive.</td> </tr> </tbody> </table>					Setting	Meaning		Mode 0	Mode 1	0	When input signal is ON (close), program table selection signal /SEL4 becomes active.	When input signal is ON (close), JOG speed table selection signal /JOG3 becomes active.	1	When input signal is OFF (open), program table selection signal /SEL4 becomes active.	When input signal is OFF (open), JOG speed table selection signal /JOG3 becomes active.	2	Program table selection signal /SEL4 is always active.	JOG speed table selection signal /JOG3 is always active.	3	Program table selection signal /SEL4 is always inactive.	JOG speed table selection signal /JOG3 is always inactive.
	Setting	Meaning																					
		Mode 0	Mode 1																				
	0	When input signal is ON (close), program table selection signal /SEL4 becomes active.	When input signal is ON (close), JOG speed table selection signal /JOG3 becomes active.																				
	1	When input signal is OFF (open), program table selection signal /SEL4 becomes active.	When input signal is OFF (open), JOG speed table selection signal /JOG3 becomes active.																				
2	Program table selection signal /SEL4 is always active.	JOG speed table selection signal /JOG3 is always active.																					
3	Program table selection signal /SEL4 is always inactive.	JOG speed table selection signal /JOG3 is always inactive.																					
PnB0B	/SEL5	0 to 3	–	0	After restart	6.1.2																	
		<table border="1"> <thead> <tr> <th rowspan="2">Setting</th> <th colspan="2">Meaning</th> </tr> </thead> <tbody> <tr> <td>0</td> <td colspan="2">When input signal is ON (close), program table selection signal /SEL5 becomes active.</td> </tr> <tr> <td>1</td> <td colspan="2">When input signal is OFF (open), program table selection signal /SEL5 becomes active.</td> </tr> <tr> <td>2</td> <td colspan="2">Program table selection signal /SEL5 is always active.</td> </tr> <tr> <td>3</td> <td colspan="2">Program table selection signal /SEL5 is always inactive.</td> </tr> </tbody> </table>					Setting	Meaning		0	When input signal is ON (close), program table selection signal /SEL5 becomes active.		1	When input signal is OFF (open), program table selection signal /SEL5 becomes active.		2	Program table selection signal /SEL5 is always active.		3	Program table selection signal /SEL5 is always inactive.			
	Setting	Meaning																					
		0	When input signal is ON (close), program table selection signal /SEL5 becomes active.																				
	1	When input signal is OFF (open), program table selection signal /SEL5 becomes active.																					
	2	Program table selection signal /SEL5 is always active.																					
3	Program table selection signal /SEL5 is always inactive.																						
PnB0C	/SEL6	0 to 3	–	0	After restart	6.1.2																	
		<table border="1"> <thead> <tr> <th rowspan="2">Setting</th> <th colspan="2">Meaning</th> </tr> </thead> <tbody> <tr> <td>0</td> <td colspan="2">When input signal is ON (close), program table selection signal /SEL6 becomes active.</td> </tr> <tr> <td>1</td> <td colspan="2">When input signal is OFF (open), program table selection signal /SEL6 becomes active.</td> </tr> <tr> <td>2</td> <td colspan="2">Program table selection signal /SEL6 is always active.</td> </tr> <tr> <td>3</td> <td colspan="2">Program table selection signal /SEL6 is always inactive.</td> </tr> </tbody> </table>					Setting	Meaning		0	When input signal is ON (close), program table selection signal /SEL6 becomes active.		1	When input signal is OFF (open), program table selection signal /SEL6 becomes active.		2	Program table selection signal /SEL6 is always active.		3	Program table selection signal /SEL6 is always inactive.			
	Setting	Meaning																					
		0	When input signal is ON (close), program table selection signal /SEL6 becomes active.																				
	1	When input signal is OFF (open), program table selection signal /SEL6 becomes active.																					
	2	Program table selection signal /SEL6 is always active.																					
3	Program table selection signal /SEL6 is always inactive.																						

(cont'd)

Parameter No.	Name	Setting Range	Setting Unit	Factory Setting	When Enabled	Reference
PnB0D	/SEL7	0 to 3	–	0	After restart	6.1.2
	Setting	Meaning				
	0	When input signal is ON (close), program table selection signal /SEL7 becomes active.				
	1	When input signal is OFF (open), program table selection signal /SEL7 becomes active.				
	2	Program table selection signal /SEL7 is always active.				
	3	Program table selection signal /SEL7 is always inactive.				
PnB0E	/S-ON	0 to 3	–	0	After restart	5.3.1
	Setting	Meaning				
	0	When input signal is ON (close), servomotor power is ON. Servomotor can be operated.				
	1	When input signal is OFF (open), servomotor power is ON. Servomotor can be operated.				
	2	Always servo ON				
	3	Always servo OFF				
PnB0F	P-OT	0 to 3	–	0	After restart	5.3.2
	Setting	Meaning				
	0	When input signal is OFF (open), forward run is prohibited (forward overtravel).				
	1	When input signal is ON (close), forward run is prohibited (forward overtravel).				
	2	Forward run is always prohibited (forward overtravel).				
	3	Forward run is always enabled. (P-OT signal is not used.)				
PnB10	N-OT	0 to 3	–	0	After restart	5.3.2
	Setting	Meaning				
	0	When input signal is OFF (open), reverse run is prohibited (reverse overtravel).				
	1	When input signal is ON (close), reverse run is prohibited (reverse overtravel).				
	2	Reverse run is always prohibited (reverse overtravel).				
	3	Reverse run is always enabled. (N-OT signal is not used.)				
PnB11	/DEC	0 to 3	–	0	After restart	6.4.2
	Setting	Meaning				
	0	Starts deceleration in homing when input signal is ON (close).				
	1	Starts deceleration in homing when input signal is OFF (open).				
	2	Sets homing limit switch always ON.				
	3	Sets homing limit switch always OFF.				
PnB12	/RGRT	0 to 3	–	0	After restart	6.2.2
	Setting	Meaning				
	0	Starts registration by switching input signal from OFF (open) to ON (close).				
	1	Starts registration by switching input signal from ON (close) to OFF (open).				
	2, 3	Does not start registration.				

(cont'd)

Parameter No.	Name	Setting Range	Setting Unit	Factory Setting	When Enabled	Reference
PnB13	/INPOSITION	0 to 3	–	0	After restart	5.3.7
	Setting	Meaning				
	0	When positioning has been completed, photocoupler becomes ON (close).				
	1	When positioning has been completed, photocoupler becomes OFF (open).				
PnB14	/POUT0	0 to 1	–	0	After restart	5.3.8
	Setting	Meaning				
	0	When programmable output signal /POUT0 is active, photocoupler becomes ON (close).				
	1	When programmable output signal /POUT0 is active, photocoupler becomes OFF (open).				
PnB15	/POUT1	0 to 1	–	0	After restart	5.3.8
	Setting	Meaning				
	0	When programmable output signal /POUT1 is active, photocoupler becomes ON (close).				
	1	When programmable output signal /POUT1 is active, photocoupler becomes OFF (open).				
PnB16	/POUT2	0 to 1	–	0	After restart	5.3.8
	Setting	Meaning				
	0	When programmable output signal /POUT2 is active, photocoupler becomes ON (close).				
	1	When programmable output signal /POUT2 is active, photocoupler becomes OFF (open).				
PnB17	/POUT3	0 to 1	–	0	After restart	5.3.8
	Setting	Meaning				
	0	When programmable output signal /POUT3 is active, photocoupler becomes ON (close).				
	1	When programmable output signal /POUT3 is active, photocoupler becomes OFF (open).				
PnB18	/POUT4	0 to 1	–	0	After restart	5.3.8
	Setting	Meaning				
	0	When programmable output signal /POUT4 is active, photocoupler becomes ON (close).				
	1	When programmable output signal /POUT4 is active, photocoupler becomes OFF (open).				
PnB19	/POUT5	0 to 1	–	0	After restart	5.3.8
	Setting	Meaning				
	0	When programmable output signal /POUT5 is active, photocoupler becomes ON (close).				
	1	When programmable output signal /POUT5 is active, photocoupler becomes OFF (open).				
PnB1A	/POUT6	0 to 1	–	0	After restart	5.3.8
	Setting	Meaning				
	0	When programmable output signal /POUT6 is active, photocoupler becomes ON (close).				
	1	When programmable output signal /POUT6 is active, photocoupler becomes OFF (open).				
PnB1B	/POUT7	0 to 1	–	0	After restart	5.3.8
	Setting	Meaning				
	0	When programmable output signal /POUT7 is active, photocoupler becomes ON (close).				
	1	When programmable output signal /POUT7 is active, photocoupler becomes OFF (open).				

(cont'd)

Parameter No.	Name	Setting Range	Setting Unit	Factory Setting	When Enabled	Reference
PnB1C	/WARN	0 to 1	–	0	After restart	5.3.6
PnB1D	/BK	0 to 1	–	0	After restart	5.3.4
PnB1E	/S-RDY	0 to 1	–	0	After restart	5.3.5
PnB1F	Overtravel (OT) Stop Method	0 to 2	–	0	After restart	5.3.2
PnB20	Moving Mode	0 to 3	–	0	After restart	5.4.2
PnB21	Linear Type (PnB20 = 0): Forward Software Limit (P-LS) Rotary Type (PnB20 ≠ 0): End Point of Rotational Coordinates	-9999999 to +9999999	Reference unit	+9999999	After restart	5.4.2
PnB23	Linear Type (PnB20 = 0): Reverse Software Limit (N-LS) Rotary Type (PnB20 ≠ 0): Starting Point of the Rotational Coordinates	-9999999 to +9999999	Reference unit	-9999999	After restart	5.4.2
PnB25	Origin (Incremental Encoder) Absolute Encoder Offset (Absolute Encoder)	-9999999 to +9999999	Reference unit	0	After restart	5.4.2, 5.4.3, 6.4.3 7.7.2
PnB27	Positioning/Registration Speed	1 to 99999999	1000 Reference units/min	1000	After restart	5.4.1
PnB29	Acceleration rate	1 to 99999999	1000 (Reference units/min) /ms	1000	Immediately	5.4.1
PnB2B	Deceleration rate	1 to 99999999	1000 (Reference units/min) /ms	1000	Immediately	5.3.2, 5.4.1

(cont'd)

Parameter No.	Name	Setting Range	Setting Unit	Factory Setting	When Enabled	Reference										
PnB2D	/INPOSITION Width	1 to 99999	Reference unit	1	Immediately	5.3.7, 6.1.4										
PnB2F	/NEAR Width	1 to 99999	Reference unit	1	Immediately	6.1.4										
PnB31	Homing Method	0 to 3	–	0	After restart	6.4.3, 7.7.2										
	<table border="1"> <thead> <tr> <th>Setting</th> <th>Meaning</th> </tr> </thead> <tbody> <tr> <td>0</td> <td>Does not execute homing.</td> </tr> <tr> <td>1</td> <td>/DEC and phase C are used for homing.</td> </tr> <tr> <td>2</td> <td>Only /DEC is used for homing.</td> </tr> <tr> <td>3</td> <td>Only phase C is used for homing.</td> </tr> </tbody> </table>	Setting	Meaning	0	Does not execute homing.	1	/DEC and phase C are used for homing.	2	Only /DEC is used for homing.	3	Only phase C is used for homing.					
	Setting	Meaning														
	0	Does not execute homing.														
	1	/DEC and phase C are used for homing.														
2	Only /DEC is used for homing.															
3	Only phase C is used for homing.															
PnB32	Homing Direction	0 to 1	–	0	Immediately	6.4.3, 7.7.2										
	<table border="1"> <thead> <tr> <th>Setting</th> <th>Meaning</th> </tr> </thead> <tbody> <tr> <td>0</td> <td>/HOME or ZRN command is used for homing in forward direction.</td> </tr> <tr> <td>1</td> <td>/HOME or ZRN command is used for homing in reverse direction.</td> </tr> </tbody> </table>	Setting	Meaning	0	/HOME or ZRN command is used for homing in forward direction.	1	/HOME or ZRN command is used for homing in reverse direction.									
	Setting	Meaning														
0	/HOME or ZRN command is used for homing in forward direction.															
1	/HOME or ZRN command is used for homing in reverse direction.															
PnB33	Homing Moving Speed	1 to 99999999	1000 Reference units/min	1000	Immediately	6.4.3, 7.7.2										
PnB35	Homing Approach Speed	1 to 99999999	1000 Reference units/min	1000	Immediately	6.4.3, 7.7.2										
PnB37	Homing Creep Speed	1 to 99999999	1000 Reference units/min	1000	Immediately	6.4.3, 7.7.2										
PnB39	Homing Final Move Distance	-99999999 to +99999999	Reference unit	0	Immediately	6.4.3, 7.7.2										
PnB3B to PnB4D	Reserved (setup information)	Do not change the setting.	–	0	–	–										
PnB4F	ZONE Signal Setting	0 to 1	–	0	After restart	5.3.8, 6.3										
	<table border="1"> <thead> <tr> <th>Setting</th> <th>Meaning</th> </tr> </thead> <tbody> <tr> <td>0</td> <td>When control power is turned ON or SERVOPACK is reset, signals /POUT0 to 7 are inactive.</td> </tr> <tr> <td>1</td> <td>When control power is turned ON or SERVOPACK is reset, signals /POUT0 to 7 are ZONE signals.</td> </tr> </tbody> </table>	Setting	Meaning	0	When control power is turned ON or SERVOPACK is reset, signals /POUT0 to 7 are inactive.	1	When control power is turned ON or SERVOPACK is reset, signals /POUT0 to 7 are ZONE signals.									
	Setting	Meaning														
0	When control power is turned ON or SERVOPACK is reset, signals /POUT0 to 7 are inactive.															
1	When control power is turned ON or SERVOPACK is reset, signals /POUT0 to 7 are ZONE signals.															
PnB50	Backlash Compensation	-1000 to +1000	Reference unit	0	Immediately	5.4.4										
PnB51	/ALO Output Selection	0 to 1	–	0	After restart	5.3.3, 5.3.5, 5.3.6										
	<table border="1"> <thead> <tr> <th>Setting</th> <th>Meaning</th> </tr> </thead> <tbody> <tr> <td>0</td> <td>Does not output /ALO1 to /ALO3. (/WARN, /BK, and /S-RDY are output.)</td> </tr> <tr> <td>1</td> <td>Outputs /ALO1 to /ALO3. (/WARN, /BK, and /S-RDY are not output.)</td> </tr> </tbody> </table>	Setting	Meaning	0	Does not output /ALO1 to /ALO3. (/WARN, /BK, and /S-RDY are output.)	1	Outputs /ALO1 to /ALO3. (/WARN, /BK, and /S-RDY are not output.)									
	Setting	Meaning														
0	Does not output /ALO1 to /ALO3. (/WARN, /BK, and /S-RDY are output.)															
1	Outputs /ALO1 to /ALO3. (/WARN, /BK, and /S-RDY are not output.)															
PnB52	/ALM-RST	0 to 3	–	0	After restart	5.3.3										
	<table border="1"> <thead> <tr> <th>Setting</th> <th>Meaning</th> </tr> </thead> <tbody> <tr> <td>0</td> <td>Resets alarms by switching input signal from OFF (open) to ON (close).</td> </tr> <tr> <td>1</td> <td>Resets alarms by switching input signal from ON (close) to OFF (open).</td> </tr> <tr> <td>2, 3</td> <td>Does not reset alarms. (Signal is ignored.)</td> </tr> </tbody> </table>	Setting	Meaning	0	Resets alarms by switching input signal from OFF (open) to ON (close).	1	Resets alarms by switching input signal from ON (close) to OFF (open).	2, 3	Does not reset alarms. (Signal is ignored.)							
	Setting	Meaning														
	0	Resets alarms by switching input signal from OFF (open) to ON (close).														
1	Resets alarms by switching input signal from ON (close) to OFF (open).															
2, 3	Does not reset alarms. (Signal is ignored.)															

10.2 Parameter List for Command Option Attachable Type SERVOPACKs

Parameter No.	Name	Setting Range	Units	Factory Setting	When Enabled	Classification																																																																																																																																																																																																																																				
Pn000	Basic Function Select Switch 0	0000 to 00B3	–	0000	After restart	Setup																																																																																																																																																																																																																																				
	<table border="0"> <tr> <td style="text-align: right;">4th digit</td> <td style="text-align: center;">□</td> <td style="text-align: right;">3rd digit</td> <td style="text-align: center;">□</td> <td style="text-align: right;">2nd digit</td> <td style="text-align: center;">□</td> <td style="text-align: right;">1st digit</td> <td style="text-align: center;">□</td> <td></td> </tr> <tr> <td colspan="8">n.</td> </tr> <tr> <td colspan="8"> <table border="1" style="width: 100%; border-collapse: collapse;"> <tr> <th colspan="2">Direction Selection (Rotational Servomotors)</th> </tr> <tr> <td style="text-align: center;">0</td> <td>Sets CCW as forward direction.</td> </tr> <tr> <td style="text-align: center;">1</td> <td>Sets CW as forward direction. (Reverse rotation mode)</td> </tr> <tr> <td style="text-align: center;">2 to 3</td> <td>Reserved (Do not change.)</td> </tr> <tr> <th colspan="2">Direction Selection (Linear Servomotors)</th> </tr> <tr> <td style="text-align: center;">0</td> <td>Sets the linear scale counting up (phase-A lead) direction as forward direction.</td> </tr> <tr> <td style="text-align: center;">1</td> <td>Sets the linear scale counting down (phase-B lead) direction as forward direction. (Reverse Movement Mode)</td> </tr> <tr> <td style="text-align: center;">2 to 3</td> <td>Reserved (Do not change.)</td> </tr> <tr> <td colspan="2">Reserved (Do not change.)</td> </tr> <tr> <td colspan="2">Reserved (Do not change.)</td> </tr> <tr> <td colspan="2">Reserved (Do not change.)</td> </tr> </table> </td> </tr> <tr> <td colspan="2">Reserved (Do not change.)</td> <td colspan="5"></td> </tr> <tr> <td colspan="2">Reserved (Do not change.)</td> <td colspan="5"></td> </tr> <tr> <td colspan="2">Reserved (Do not change.)</td> <td colspan="5"></td> </tr> <tr> <td colspan="2">Reserved (Do not change.)</td> <td colspan="5"></td> </tr> <tr> <td colspan="2">Reserved (Do not change.)</td> <td colspan="5"></td> </tr> <tr> <td colspan="2">Reserved (Do not change.)</td> <td colspan="5"></td> </tr> <tr> <td colspan="2">Reserved (Do not change.)</td> <td colspan="5"></td> </tr> <tr> <td colspan="2">Reserved (Do not change.)</td> <td colspan="5"></td> </tr> <tr> <td rowspan="10">Pn001</td> <td>Application Function Select Switch 1</td> <td>0000 to 1122</td> <td>–</td> <td>0000</td> <td>After restart</td> <td>Setup</td> </tr> <tr> <td colspan="7"> <table border="0"> <tr> <td style="text-align: right;">4th digit</td> <td style="text-align: center;">□</td> <td style="text-align: right;">3rd digit</td> <td style="text-align: center;">□</td> <td style="text-align: right;">2nd digit</td> <td style="text-align: center;">□</td> <td style="text-align: right;">1st digit</td> <td style="text-align: center;">□</td> <td></td> </tr> <tr> <td colspan="8">n.</td> </tr> <tr> <td colspan="8"> <table border="1" style="width: 100%; border-collapse: collapse;"> <tr> <th colspan="2">Servomotor power OFF or Alarm Gr.1 Stop Mode</th> </tr> <tr> <td style="text-align: center;">0</td> <td>Stops the motor by applying DB (dynamic brake).</td> </tr> <tr> <td style="text-align: center;">1</td> <td>Stops the motor by applying dynamic brake (DB) and then releases DB.</td> </tr> <tr> <td style="text-align: center;">2</td> <td>Makes the motor coast to a stop state without using the dynamic brake (DB).</td> </tr> <tr> <td colspan="2">Reserved (Do not change.)</td> </tr> <tr> <th colspan="2">AC/DC Power Input Selection</th> </tr> <tr> <td style="text-align: center;">0</td> <td>Applicable to AC power input: Input AC power supply through L1, L2, and L3 terminals.</td> </tr> <tr> <td style="text-align: center;">1</td> <td>Applicable to DC power input: Input DC power supply between B1/ + and -2, or input DC power supply between B1 and -2.</td> </tr> <tr> <th colspan="2">Warning Code Output Selection</th> </tr> <tr> <td style="text-align: center;">0</td> <td>ALO1, ALO2, and ALO3 output only alarm codes.</td> </tr> <tr> <td style="text-align: center;">1</td> <td>ALO1, ALO2, and ALO3 output both alarm codes and warning codes. While warning codes are output, ALM signal output remains ON (normal state).</td> </tr> </table> </td> </tr> <tr> <td colspan="2">Reserved (Do not change.)</td> <td colspan="5"></td> </tr> <tr> <td colspan="2">Reserved (Do not change.)</td> <td colspan="5"></td> </tr> <tr> <td colspan="2">Reserved (Do not change.)</td> <td colspan="5"></td> </tr> <tr> <td colspan="2">Reserved (Do not change.)</td> <td colspan="5"></td> </tr> <tr> <td colspan="2">Reserved (Do not change.)</td> <td colspan="5"></td> </tr> <tr> <td colspan="2">Reserved (Do not change.)</td> <td colspan="5"></td> </tr> <tr> <td colspan="2">Reserved (Do not change.)</td> <td colspan="5"></td> </tr> <tr> <td colspan="2">Reserved (Do not change.)</td> <td colspan="5"></td> </tr> <tr> <td colspan="2">Reserved (Do not change.)</td> <td colspan="5"></td> </tr> </table></td></tr></table>							4th digit	□	3rd digit	□	2nd digit	□	1st digit	□		n.								<table border="1" style="width: 100%; border-collapse: collapse;"> <tr> <th colspan="2">Direction Selection (Rotational Servomotors)</th> </tr> <tr> <td style="text-align: center;">0</td> <td>Sets CCW as forward direction.</td> </tr> <tr> <td style="text-align: center;">1</td> <td>Sets CW as forward direction. (Reverse rotation mode)</td> </tr> <tr> <td style="text-align: center;">2 to 3</td> <td>Reserved (Do not change.)</td> </tr> <tr> <th colspan="2">Direction Selection (Linear Servomotors)</th> </tr> <tr> <td style="text-align: center;">0</td> <td>Sets the linear scale counting up (phase-A lead) direction as forward direction.</td> </tr> <tr> <td style="text-align: center;">1</td> <td>Sets the linear scale counting down (phase-B lead) direction as forward direction. (Reverse Movement Mode)</td> </tr> <tr> <td style="text-align: center;">2 to 3</td> <td>Reserved (Do not change.)</td> </tr> <tr> <td colspan="2">Reserved (Do not change.)</td> </tr> <tr> <td colspan="2">Reserved (Do not change.)</td> </tr> <tr> <td colspan="2">Reserved (Do not change.)</td> </tr> </table>								Direction Selection (Rotational Servomotors)		0	Sets CCW as forward direction.	1	Sets CW as forward direction. (Reverse rotation mode)	2 to 3	Reserved (Do not change.)	Direction Selection (Linear Servomotors)		0	Sets the linear scale counting up (phase-A lead) direction as forward direction.	1	Sets the linear scale counting down (phase-B lead) direction as forward direction. (Reverse Movement Mode)	2 to 3	Reserved (Do not change.)	Reserved (Do not change.)		Reserved (Do not change.)		Reserved (Do not change.)		Reserved (Do not change.)							Reserved (Do not change.)							Reserved (Do not change.)							Reserved (Do not change.)							Reserved (Do not change.)							Reserved (Do not change.)							Reserved (Do not change.)							Reserved (Do not change.)							Pn001	Application Function Select Switch 1	0000 to 1122	–	0000	After restart	Setup	<table border="0"> <tr> <td style="text-align: right;">4th digit</td> <td style="text-align: center;">□</td> <td style="text-align: right;">3rd digit</td> <td style="text-align: center;">□</td> <td style="text-align: right;">2nd digit</td> <td style="text-align: center;">□</td> <td style="text-align: right;">1st digit</td> <td style="text-align: center;">□</td> <td></td> </tr> <tr> <td colspan="8">n.</td> </tr> <tr> <td colspan="8"> <table border="1" style="width: 100%; border-collapse: collapse;"> <tr> <th colspan="2">Servomotor power OFF or Alarm Gr.1 Stop Mode</th> </tr> <tr> <td style="text-align: center;">0</td> <td>Stops the motor by applying DB (dynamic brake).</td> </tr> <tr> <td style="text-align: center;">1</td> <td>Stops the motor by applying dynamic brake (DB) and then releases DB.</td> </tr> <tr> <td style="text-align: center;">2</td> <td>Makes the motor coast to a stop state without using the dynamic brake (DB).</td> </tr> <tr> <td colspan="2">Reserved (Do not change.)</td> </tr> <tr> <th colspan="2">AC/DC Power Input Selection</th> </tr> <tr> <td style="text-align: center;">0</td> <td>Applicable to AC power input: Input AC power supply through L1, L2, and L3 terminals.</td> </tr> <tr> <td style="text-align: center;">1</td> <td>Applicable to DC power input: Input DC power supply between B1/ + and -2, or input DC power supply between B1 and -2.</td> </tr> <tr> <th colspan="2">Warning Code Output Selection</th> </tr> <tr> <td style="text-align: center;">0</td> <td>ALO1, ALO2, and ALO3 output only alarm codes.</td> </tr> <tr> <td style="text-align: center;">1</td> <td>ALO1, ALO2, and ALO3 output both alarm codes and warning codes. While warning codes are output, ALM signal output remains ON (normal state).</td> </tr> </table> </td> </tr> <tr> <td colspan="2">Reserved (Do not change.)</td> <td colspan="5"></td> </tr> <tr> <td colspan="2">Reserved (Do not change.)</td> <td colspan="5"></td> </tr> <tr> <td colspan="2">Reserved (Do not change.)</td> <td colspan="5"></td> </tr> <tr> <td colspan="2">Reserved (Do not change.)</td> <td colspan="5"></td> </tr> <tr> <td colspan="2">Reserved (Do not change.)</td> <td colspan="5"></td> </tr> <tr> <td colspan="2">Reserved (Do not change.)</td> <td colspan="5"></td> </tr> <tr> <td colspan="2">Reserved (Do not change.)</td> <td colspan="5"></td> </tr> <tr> <td colspan="2">Reserved (Do not change.)</td> <td colspan="5"></td> </tr> <tr> <td colspan="2">Reserved (Do not change.)</td> <td colspan="5"></td> </tr> </table>							4th digit	□	3rd digit	□	2nd digit	□	1st digit	□		n.								<table border="1" style="width: 100%; border-collapse: collapse;"> <tr> <th colspan="2">Servomotor power OFF or Alarm Gr.1 Stop Mode</th> </tr> <tr> <td style="text-align: center;">0</td> <td>Stops the motor by applying DB (dynamic brake).</td> </tr> <tr> <td style="text-align: center;">1</td> <td>Stops the motor by applying dynamic brake (DB) and then releases DB.</td> </tr> <tr> <td style="text-align: center;">2</td> <td>Makes the motor coast to a stop state without using the dynamic brake (DB).</td> </tr> <tr> <td colspan="2">Reserved (Do not change.)</td> </tr> <tr> <th colspan="2">AC/DC Power Input Selection</th> </tr> <tr> <td style="text-align: center;">0</td> <td>Applicable to AC power input: Input AC power supply through L1, L2, and L3 terminals.</td> </tr> <tr> <td style="text-align: center;">1</td> <td>Applicable to DC power input: Input DC power supply between B1/ + and -2, or input DC power supply between B1 and -2.</td> </tr> <tr> <th colspan="2">Warning Code Output Selection</th> </tr> <tr> <td style="text-align: center;">0</td> <td>ALO1, ALO2, and ALO3 output only alarm codes.</td> </tr> <tr> <td style="text-align: center;">1</td> <td>ALO1, ALO2, and ALO3 output both alarm codes and warning codes. While warning codes are output, ALM signal output remains ON (normal state).</td> </tr> </table>								Servomotor power OFF or Alarm Gr.1 Stop Mode		0	Stops the motor by applying DB (dynamic brake).	1	Stops the motor by applying dynamic brake (DB) and then releases DB.	2	Makes the motor coast to a stop state without using the dynamic brake (DB).	Reserved (Do not change.)		AC/DC Power Input Selection		0	Applicable to AC power input: Input AC power supply through L1, L2, and L3 terminals.	1	Applicable to DC power input: Input DC power supply between B1/ + and -2, or input DC power supply between B1 and -2.	Warning Code Output Selection		0	ALO1, ALO2, and ALO3 output only alarm codes.	1	ALO1, ALO2, and ALO3 output both alarm codes and warning codes. While warning codes are output, ALM signal output remains ON (normal state).	Reserved (Do not change.)							Reserved (Do not change.)							Reserved (Do not change.)							Reserved (Do not change.)							Reserved (Do not change.)							Reserved (Do not change.)							Reserved (Do not change.)							Reserved (Do not change.)							Reserved (Do not change.)						
	4th digit	□	3rd digit	□	2nd digit	□	1st digit	□																																																																																																																																																																																																																																		
	n.																																																																																																																																																																																																																																									
	<table border="1" style="width: 100%; border-collapse: collapse;"> <tr> <th colspan="2">Direction Selection (Rotational Servomotors)</th> </tr> <tr> <td style="text-align: center;">0</td> <td>Sets CCW as forward direction.</td> </tr> <tr> <td style="text-align: center;">1</td> <td>Sets CW as forward direction. (Reverse rotation mode)</td> </tr> <tr> <td style="text-align: center;">2 to 3</td> <td>Reserved (Do not change.)</td> </tr> <tr> <th colspan="2">Direction Selection (Linear Servomotors)</th> </tr> <tr> <td style="text-align: center;">0</td> <td>Sets the linear scale counting up (phase-A lead) direction as forward direction.</td> </tr> <tr> <td style="text-align: center;">1</td> <td>Sets the linear scale counting down (phase-B lead) direction as forward direction. (Reverse Movement Mode)</td> </tr> <tr> <td style="text-align: center;">2 to 3</td> <td>Reserved (Do not change.)</td> </tr> <tr> <td colspan="2">Reserved (Do not change.)</td> </tr> <tr> <td colspan="2">Reserved (Do not change.)</td> </tr> <tr> <td colspan="2">Reserved (Do not change.)</td> </tr> </table>								Direction Selection (Rotational Servomotors)		0	Sets CCW as forward direction.	1	Sets CW as forward direction. (Reverse rotation mode)	2 to 3	Reserved (Do not change.)	Direction Selection (Linear Servomotors)		0	Sets the linear scale counting up (phase-A lead) direction as forward direction.	1	Sets the linear scale counting down (phase-B lead) direction as forward direction. (Reverse Movement Mode)	2 to 3	Reserved (Do not change.)	Reserved (Do not change.)		Reserved (Do not change.)		Reserved (Do not change.)																																																																																																																																																																																																													
	Direction Selection (Rotational Servomotors)																																																																																																																																																																																																																																									
	0	Sets CCW as forward direction.																																																																																																																																																																																																																																								
	1	Sets CW as forward direction. (Reverse rotation mode)																																																																																																																																																																																																																																								
	2 to 3	Reserved (Do not change.)																																																																																																																																																																																																																																								
	Direction Selection (Linear Servomotors)																																																																																																																																																																																																																																									
0	Sets the linear scale counting up (phase-A lead) direction as forward direction.																																																																																																																																																																																																																																									
1	Sets the linear scale counting down (phase-B lead) direction as forward direction. (Reverse Movement Mode)																																																																																																																																																																																																																																									
2 to 3	Reserved (Do not change.)																																																																																																																																																																																																																																									
Reserved (Do not change.)																																																																																																																																																																																																																																										
Reserved (Do not change.)																																																																																																																																																																																																																																										
Reserved (Do not change.)																																																																																																																																																																																																																																										
Reserved (Do not change.)																																																																																																																																																																																																																																										
Reserved (Do not change.)																																																																																																																																																																																																																																										
Reserved (Do not change.)																																																																																																																																																																																																																																										
Reserved (Do not change.)																																																																																																																																																																																																																																										
Reserved (Do not change.)																																																																																																																																																																																																																																										
Reserved (Do not change.)																																																																																																																																																																																																																																										
Reserved (Do not change.)																																																																																																																																																																																																																																										
Reserved (Do not change.)																																																																																																																																																																																																																																										
Pn001	Application Function Select Switch 1	0000 to 1122	–	0000	After restart	Setup																																																																																																																																																																																																																																				
	<table border="0"> <tr> <td style="text-align: right;">4th digit</td> <td style="text-align: center;">□</td> <td style="text-align: right;">3rd digit</td> <td style="text-align: center;">□</td> <td style="text-align: right;">2nd digit</td> <td style="text-align: center;">□</td> <td style="text-align: right;">1st digit</td> <td style="text-align: center;">□</td> <td></td> </tr> <tr> <td colspan="8">n.</td> </tr> <tr> <td colspan="8"> <table border="1" style="width: 100%; border-collapse: collapse;"> <tr> <th colspan="2">Servomotor power OFF or Alarm Gr.1 Stop Mode</th> </tr> <tr> <td style="text-align: center;">0</td> <td>Stops the motor by applying DB (dynamic brake).</td> </tr> <tr> <td style="text-align: center;">1</td> <td>Stops the motor by applying dynamic brake (DB) and then releases DB.</td> </tr> <tr> <td style="text-align: center;">2</td> <td>Makes the motor coast to a stop state without using the dynamic brake (DB).</td> </tr> <tr> <td colspan="2">Reserved (Do not change.)</td> </tr> <tr> <th colspan="2">AC/DC Power Input Selection</th> </tr> <tr> <td style="text-align: center;">0</td> <td>Applicable to AC power input: Input AC power supply through L1, L2, and L3 terminals.</td> </tr> <tr> <td style="text-align: center;">1</td> <td>Applicable to DC power input: Input DC power supply between B1/ + and -2, or input DC power supply between B1 and -2.</td> </tr> <tr> <th colspan="2">Warning Code Output Selection</th> </tr> <tr> <td style="text-align: center;">0</td> <td>ALO1, ALO2, and ALO3 output only alarm codes.</td> </tr> <tr> <td style="text-align: center;">1</td> <td>ALO1, ALO2, and ALO3 output both alarm codes and warning codes. While warning codes are output, ALM signal output remains ON (normal state).</td> </tr> </table> </td> </tr> <tr> <td colspan="2">Reserved (Do not change.)</td> <td colspan="5"></td> </tr> <tr> <td colspan="2">Reserved (Do not change.)</td> <td colspan="5"></td> </tr> <tr> <td colspan="2">Reserved (Do not change.)</td> <td colspan="5"></td> </tr> <tr> <td colspan="2">Reserved (Do not change.)</td> <td colspan="5"></td> </tr> <tr> <td colspan="2">Reserved (Do not change.)</td> <td colspan="5"></td> </tr> <tr> <td colspan="2">Reserved (Do not change.)</td> <td colspan="5"></td> </tr> <tr> <td colspan="2">Reserved (Do not change.)</td> <td colspan="5"></td> </tr> <tr> <td colspan="2">Reserved (Do not change.)</td> <td colspan="5"></td> </tr> <tr> <td colspan="2">Reserved (Do not change.)</td> <td colspan="5"></td> </tr> </table>							4th digit	□	3rd digit	□	2nd digit	□	1st digit	□		n.								<table border="1" style="width: 100%; border-collapse: collapse;"> <tr> <th colspan="2">Servomotor power OFF or Alarm Gr.1 Stop Mode</th> </tr> <tr> <td style="text-align: center;">0</td> <td>Stops the motor by applying DB (dynamic brake).</td> </tr> <tr> <td style="text-align: center;">1</td> <td>Stops the motor by applying dynamic brake (DB) and then releases DB.</td> </tr> <tr> <td style="text-align: center;">2</td> <td>Makes the motor coast to a stop state without using the dynamic brake (DB).</td> </tr> <tr> <td colspan="2">Reserved (Do not change.)</td> </tr> <tr> <th colspan="2">AC/DC Power Input Selection</th> </tr> <tr> <td style="text-align: center;">0</td> <td>Applicable to AC power input: Input AC power supply through L1, L2, and L3 terminals.</td> </tr> <tr> <td style="text-align: center;">1</td> <td>Applicable to DC power input: Input DC power supply between B1/ + and -2, or input DC power supply between B1 and -2.</td> </tr> <tr> <th colspan="2">Warning Code Output Selection</th> </tr> <tr> <td style="text-align: center;">0</td> <td>ALO1, ALO2, and ALO3 output only alarm codes.</td> </tr> <tr> <td style="text-align: center;">1</td> <td>ALO1, ALO2, and ALO3 output both alarm codes and warning codes. While warning codes are output, ALM signal output remains ON (normal state).</td> </tr> </table>								Servomotor power OFF or Alarm Gr.1 Stop Mode		0	Stops the motor by applying DB (dynamic brake).	1	Stops the motor by applying dynamic brake (DB) and then releases DB.	2	Makes the motor coast to a stop state without using the dynamic brake (DB).	Reserved (Do not change.)		AC/DC Power Input Selection		0	Applicable to AC power input: Input AC power supply through L1, L2, and L3 terminals.	1	Applicable to DC power input: Input DC power supply between B1/ + and -2, or input DC power supply between B1 and -2.	Warning Code Output Selection		0	ALO1, ALO2, and ALO3 output only alarm codes.	1	ALO1, ALO2, and ALO3 output both alarm codes and warning codes. While warning codes are output, ALM signal output remains ON (normal state).	Reserved (Do not change.)							Reserved (Do not change.)							Reserved (Do not change.)							Reserved (Do not change.)							Reserved (Do not change.)							Reserved (Do not change.)							Reserved (Do not change.)							Reserved (Do not change.)							Reserved (Do not change.)																																																																																																																											
	4th digit	□	3rd digit	□	2nd digit	□	1st digit	□																																																																																																																																																																																																																																		
	n.																																																																																																																																																																																																																																									
	<table border="1" style="width: 100%; border-collapse: collapse;"> <tr> <th colspan="2">Servomotor power OFF or Alarm Gr.1 Stop Mode</th> </tr> <tr> <td style="text-align: center;">0</td> <td>Stops the motor by applying DB (dynamic brake).</td> </tr> <tr> <td style="text-align: center;">1</td> <td>Stops the motor by applying dynamic brake (DB) and then releases DB.</td> </tr> <tr> <td style="text-align: center;">2</td> <td>Makes the motor coast to a stop state without using the dynamic brake (DB).</td> </tr> <tr> <td colspan="2">Reserved (Do not change.)</td> </tr> <tr> <th colspan="2">AC/DC Power Input Selection</th> </tr> <tr> <td style="text-align: center;">0</td> <td>Applicable to AC power input: Input AC power supply through L1, L2, and L3 terminals.</td> </tr> <tr> <td style="text-align: center;">1</td> <td>Applicable to DC power input: Input DC power supply between B1/ + and -2, or input DC power supply between B1 and -2.</td> </tr> <tr> <th colspan="2">Warning Code Output Selection</th> </tr> <tr> <td style="text-align: center;">0</td> <td>ALO1, ALO2, and ALO3 output only alarm codes.</td> </tr> <tr> <td style="text-align: center;">1</td> <td>ALO1, ALO2, and ALO3 output both alarm codes and warning codes. While warning codes are output, ALM signal output remains ON (normal state).</td> </tr> </table>								Servomotor power OFF or Alarm Gr.1 Stop Mode		0	Stops the motor by applying DB (dynamic brake).	1	Stops the motor by applying dynamic brake (DB) and then releases DB.	2	Makes the motor coast to a stop state without using the dynamic brake (DB).	Reserved (Do not change.)		AC/DC Power Input Selection		0	Applicable to AC power input: Input AC power supply through L1, L2, and L3 terminals.	1	Applicable to DC power input: Input DC power supply between B1/ + and -2, or input DC power supply between B1 and -2.	Warning Code Output Selection		0	ALO1, ALO2, and ALO3 output only alarm codes.	1	ALO1, ALO2, and ALO3 output both alarm codes and warning codes. While warning codes are output, ALM signal output remains ON (normal state).																																																																																																																																																																																																												
	Servomotor power OFF or Alarm Gr.1 Stop Mode																																																																																																																																																																																																																																									
	0	Stops the motor by applying DB (dynamic brake).																																																																																																																																																																																																																																								
	1	Stops the motor by applying dynamic brake (DB) and then releases DB.																																																																																																																																																																																																																																								
	2	Makes the motor coast to a stop state without using the dynamic brake (DB).																																																																																																																																																																																																																																								
	Reserved (Do not change.)																																																																																																																																																																																																																																									
AC/DC Power Input Selection																																																																																																																																																																																																																																										
0	Applicable to AC power input: Input AC power supply through L1, L2, and L3 terminals.																																																																																																																																																																																																																																									
1	Applicable to DC power input: Input DC power supply between B1/ + and -2, or input DC power supply between B1 and -2.																																																																																																																																																																																																																																									
Warning Code Output Selection																																																																																																																																																																																																																																										
0	ALO1, ALO2, and ALO3 output only alarm codes.																																																																																																																																																																																																																																									
1	ALO1, ALO2, and ALO3 output both alarm codes and warning codes. While warning codes are output, ALM signal output remains ON (normal state).																																																																																																																																																																																																																																									
Reserved (Do not change.)																																																																																																																																																																																																																																										
Reserved (Do not change.)																																																																																																																																																																																																																																										
Reserved (Do not change.)																																																																																																																																																																																																																																										
Reserved (Do not change.)																																																																																																																																																																																																																																										
Reserved (Do not change.)																																																																																																																																																																																																																																										
Reserved (Do not change.)																																																																																																																																																																																																																																										
Reserved (Do not change.)																																																																																																																																																																																																																																										
Reserved (Do not change.)																																																																																																																																																																																																																																										
Reserved (Do not change.)																																																																																																																																																																																																																																										

(cont'd)

Parameter No.	Name	Setting Range	Units	Factory Setting	When Enabled	Classification								
Pn002	Application Function Select Switch 2	0000 to 4113	–	0000	After restart	Setup								
	n.	<table border="0"> <tr> <td style="text-align: center;">4th digit</td> <td style="text-align: center;">3rd digit</td> <td style="text-align: center;">2nd digit</td> <td style="text-align: center;">1st digit</td> </tr> <tr> <td style="text-align: center;">□</td> <td style="text-align: center;">□</td> <td style="text-align: center;">□</td> <td style="text-align: center;">□</td> </tr> </table>	4th digit	3rd digit	2nd digit	1st digit	□	□	□	□				
	4th digit	3rd digit	2nd digit	1st digit										
	□	□	□	□										
		Reserved (Do not change.)												
		Reserved (Do not change.)												
		Absolute Encoder Usage (Rotational Servomotors)												
		0	Uses absolute encoder as an absolute encoder.											
		1	Uses absolute encoder as an incremental encoder.											
		Absolute Linear Scale Usage (Linear Servomotors)												
		0	Uses absolute linear scale as an absolute linear scale.											
		1	Uses absolute linear scale as an incremental linear scale.											
		External Encoder Usage (Rotational Servomotors)												
		0	Does not use external encoder.											
		1	Uses external encoder for forward rotation direction.											
	2	Reversed (Do not change.)												
	3	Uses external encoder for reverse rotation direction.												
	4	Reversed (Do not change.)												
	Reserved (Do not change.) (Linear Servomotors)													

(cont'd)

Parameter No.	Name	Setting Range	Units	Factory Setting	When Enabled	Classification																																		
Pn006	Application Function Select Switch 6	0000 to 005F	–	0002	Immediately	Setup																																		
	<div style="display: flex; align-items: center;"> <div style="margin-right: 10px;">n.</div> <div style="display: flex; gap: 5px;"> <div style="text-align: center;">4th digit <input type="checkbox"/></div> <div style="text-align: center;">3rd digit <input type="checkbox"/></div> <div style="text-align: center;">2nd digit <input type="checkbox"/></div> <div style="text-align: center;">1st digit <input type="checkbox"/></div> </div> </div> <table border="1" style="width: 100%; border-collapse: collapse;"> <thead> <tr> <th colspan="2" style="background-color: #cccccc;">Analog Monitor 1 Signal Selection</th> </tr> </thead> <tbody> <tr> <td style="text-align: center;">00</td> <td>Motor speed (1 V/1000 min⁻¹) (Rotational servomotors) Motor speed (1 V/1000 mm/s) (Linear servomotors)</td> </tr> <tr> <td style="text-align: center;">01</td> <td>Speed reference (1 V/1000 min⁻¹) (Rotational servomotors) Speed reference (1 V/1000 mm/s) (Linear servomotors)</td> </tr> <tr> <td style="text-align: center;">02</td> <td>Torque reference (1 V/100%) (Rotational servomotors) Force reference (1 V/100%) (Linear servomotors)</td> </tr> <tr> <td style="text-align: center;">03</td> <td>Position error (0.05 V/1 reference unit)</td> </tr> <tr> <td style="text-align: center;">04</td> <td>Position amplifier error (after electronic gears) (0.05 V/ 1 encoder pulse unit)</td> </tr> <tr> <td style="text-align: center;">05</td> <td>Position reference speed (1 V/1000 min⁻¹) (Rotational servomotors) Position reference speed (1 V/1000 mm/s) (Linear servomotors)</td> </tr> <tr> <td style="text-align: center;">06</td> <td>Reserved (Do not change.)</td> </tr> <tr> <td style="text-align: center;">07</td> <td>Motor-load position error (0.01 V/1 reference unit) (Rotational servomotors) Reserved (Do not change.) (Linear servomotors)</td> </tr> <tr> <td style="text-align: center;">08</td> <td>Positioning completion (positioning completed: 5 V, positioning not completed: 0 V)</td> </tr> <tr> <td style="text-align: center;">09</td> <td>Speed feedforward (1 V/1000 min⁻¹) (Rotational servomotors) Speed feedforward (1 V/1000 mm/s) (Linear servomotors)</td> </tr> <tr> <td style="text-align: center;">0A</td> <td>Torque feedforward (1 V/100%) (Rotational servomotors) Force feedforward (1 V/100%) (Linear servomotors)</td> </tr> <tr> <td style="text-align: center;">0B</td> <td>Active gain (1st gain: 1 V, 2nd gain: 2 V)</td> </tr> <tr> <td style="text-align: center;">0C</td> <td>Completion of position reference distribution (completed: 5 V, not completed: 0 V)</td> </tr> <tr> <td style="text-align: center;">0D</td> <td>External encoder speed (1 V/1000 min⁻¹) (Rotational servomotors) Reserved (Do not change.) (Linear servomotors)</td> </tr> <tr> <td colspan="2" style="background-color: #cccccc;">Reserved (Do not change.)</td> </tr> <tr> <td colspan="2" style="background-color: #cccccc;">Reserved (Do not change.)</td> </tr> </tbody> </table>						Analog Monitor 1 Signal Selection		00	Motor speed (1 V/1000 min ⁻¹) (Rotational servomotors) Motor speed (1 V/1000 mm/s) (Linear servomotors)	01	Speed reference (1 V/1000 min ⁻¹) (Rotational servomotors) Speed reference (1 V/1000 mm/s) (Linear servomotors)	02	Torque reference (1 V/100%) (Rotational servomotors) Force reference (1 V/100%) (Linear servomotors)	03	Position error (0.05 V/1 reference unit)	04	Position amplifier error (after electronic gears) (0.05 V/ 1 encoder pulse unit)	05	Position reference speed (1 V/1000 min ⁻¹) (Rotational servomotors) Position reference speed (1 V/1000 mm/s) (Linear servomotors)	06	Reserved (Do not change.)	07	Motor-load position error (0.01 V/1 reference unit) (Rotational servomotors) Reserved (Do not change.) (Linear servomotors)	08	Positioning completion (positioning completed: 5 V, positioning not completed: 0 V)	09	Speed feedforward (1 V/1000 min ⁻¹) (Rotational servomotors) Speed feedforward (1 V/1000 mm/s) (Linear servomotors)	0A	Torque feedforward (1 V/100%) (Rotational servomotors) Force feedforward (1 V/100%) (Linear servomotors)	0B	Active gain (1st gain: 1 V, 2nd gain: 2 V)	0C	Completion of position reference distribution (completed: 5 V, not completed: 0 V)	0D	External encoder speed (1 V/1000 min ⁻¹) (Rotational servomotors) Reserved (Do not change.) (Linear servomotors)	Reserved (Do not change.)		Reserved (Do not change.)	
	Analog Monitor 1 Signal Selection																																							
	00	Motor speed (1 V/1000 min ⁻¹) (Rotational servomotors) Motor speed (1 V/1000 mm/s) (Linear servomotors)																																						
	01	Speed reference (1 V/1000 min ⁻¹) (Rotational servomotors) Speed reference (1 V/1000 mm/s) (Linear servomotors)																																						
	02	Torque reference (1 V/100%) (Rotational servomotors) Force reference (1 V/100%) (Linear servomotors)																																						
	03	Position error (0.05 V/1 reference unit)																																						
	04	Position amplifier error (after electronic gears) (0.05 V/ 1 encoder pulse unit)																																						
	05	Position reference speed (1 V/1000 min ⁻¹) (Rotational servomotors) Position reference speed (1 V/1000 mm/s) (Linear servomotors)																																						
	06	Reserved (Do not change.)																																						
	07	Motor-load position error (0.01 V/1 reference unit) (Rotational servomotors) Reserved (Do not change.) (Linear servomotors)																																						
	08	Positioning completion (positioning completed: 5 V, positioning not completed: 0 V)																																						
	09	Speed feedforward (1 V/1000 min ⁻¹) (Rotational servomotors) Speed feedforward (1 V/1000 mm/s) (Linear servomotors)																																						
	0A	Torque feedforward (1 V/100%) (Rotational servomotors) Force feedforward (1 V/100%) (Linear servomotors)																																						
	0B	Active gain (1st gain: 1 V, 2nd gain: 2 V)																																						
	0C	Completion of position reference distribution (completed: 5 V, not completed: 0 V)																																						
	0D	External encoder speed (1 V/1000 min ⁻¹) (Rotational servomotors) Reserved (Do not change.) (Linear servomotors)																																						
	Reserved (Do not change.)																																							
	Reserved (Do not change.)																																							

(cont'd)

Parameter No.	Name	Setting Range	Units	Factory Setting	When Enabled	Classification	
Pn007	Application Function Select Switch 7	0000 to 005F	–	0000	Immediately	Setup	
	<div style="display: flex; justify-content: space-around; align-items: center;"> <div style="text-align: center;"> <p>n.</p> <input type="checkbox"/> </div> <div style="text-align: center;"> <p>4th digit</p> <input type="checkbox"/> </div> <div style="text-align: center;"> <p>3rd digit</p> <input type="checkbox"/> </div> <div style="text-align: center;"> <p>2nd digit</p> <input type="checkbox"/> </div> <div style="text-align: center;"> <p>1st digit</p> <input type="checkbox"/> </div> </div>						
	Analog Monitor 2 Signal Selection						
	00		Motor speed (1 V/1000 min ⁻¹) (Rotational servomotors) Motor speed (1 V/1000 mm/s) (Linear servomotors)				
	01		Speed reference (1 V/1000 min ⁻¹) (Rotational servomotors) Speed reference (1 V/1000 mm/s) (Linear servomotors)				
	02		Torque reference (1 V/100%) (Rotational servomotors) Force reference (1 V/100%) (Linear servomotors)				
	03		Position error (0.05 V/1 reference unit)				
	04		Position amplifier error (after electronic gears) (0.05 V/ 1 encoder pulse unit)				
	05		Position reference speed (1 V/1000 min ⁻¹) (Rotational servomotors) Position reference speed (1 V/1000 mm/s) (Linear servomotors)				
	06		Reserved (Do not change.)				
	07		Motor-load position error (0.01 V/1 reference unit) (Rotational servomotors) Reserved (Do not change.) (Linear servomotors)				
	08		Positioning completion (positioning completed: 5 V, positioning not completed: 0 V)				
	09		Speed feedforward (1 V/1000 min ⁻¹) (Rotational servomotors) Speed feedforward (1 V/1000 mm/s) (Linear servomotors)				
	0A		Torque feedforward (1 V/100%) (Rotational servomotors) Force feedforward (1 V/100%) (Linear servomotors)				
	0B		Active gain (1st gain: 1 V, 2nd gain: 2 V)				
	0C		Completion of position reference distribution (completed: 5 V not completed: 0 V)				
	0D		External encoder speed (1 V/1000 min ⁻¹) (Rotational servomotors) Reserved (Do not change.) (Linear servomotors)				
	Reserved (Do not change.)						
	Reserved (Do not change.)						

(cont'd)

Parameter No.	Name	Setting Range	Units	Factory Setting	When Enabled	Classification																	
Pn008	Application Function Select Switch 8	0000 to 7121	–	4000	After restart	Setup																	
	<table border="0" style="width: 100%; border-collapse: collapse;"> <tr> <td style="width: 10%;"></td> <td style="width: 10%; text-align: center;">4th digit</td> <td style="width: 10%; text-align: center;">3rd digit</td> <td style="width: 10%; text-align: center;">2nd digit</td> <td style="width: 10%; text-align: center;">1st digit</td> <td colspan="2"></td> </tr> <tr> <td>n.</td> <td style="text-align: center;"><input type="checkbox"/></td> <td style="text-align: center;"><input type="checkbox"/></td> <td style="text-align: center;"><input type="checkbox"/></td> <td style="text-align: center;"><input type="checkbox"/></td> <td colspan="2"></td> </tr> </table>								4th digit	3rd digit	2nd digit	1st digit			n.	<input type="checkbox"/>	<input type="checkbox"/>	<input type="checkbox"/>	<input type="checkbox"/>				
		4th digit	3rd digit	2nd digit	1st digit																		
	n.	<input type="checkbox"/>	<input type="checkbox"/>	<input type="checkbox"/>	<input type="checkbox"/>																		
	<table border="1" style="width: 100%; border-collapse: collapse;"> <tr> <td colspan="2" style="background-color: #cccccc;">Lowered Battery Voltage Alarm/Warning Selection (Rotational Servomotors)</td> </tr> <tr> <td style="width: 5%; text-align: center;">0</td> <td>Outputs alarm (A.830) for lowered battery voltage.</td> </tr> <tr> <td style="text-align: center;">1</td> <td>Outputs warning (A.930) for lowered battery voltage.</td> </tr> <tr> <td colspan="2" style="background-color: #cccccc;">Reserved (Do not change.)</td> </tr> </table>							Lowered Battery Voltage Alarm/Warning Selection (Rotational Servomotors)		0	Outputs alarm (A.830) for lowered battery voltage.	1	Outputs warning (A.930) for lowered battery voltage.	Reserved (Do not change.)									
	Lowered Battery Voltage Alarm/Warning Selection (Rotational Servomotors)																						
	0	Outputs alarm (A.830) for lowered battery voltage.																					
	1	Outputs warning (A.930) for lowered battery voltage.																					
	Reserved (Do not change.)																						
	<table border="1" style="width: 100%; border-collapse: collapse;"> <tr> <td colspan="2" style="background-color: #cccccc;">Function Selection for Insufficient voltage</td> </tr> <tr> <td style="width: 5%; text-align: center;">0</td> <td>Disables detection of insufficient voltages.</td> </tr> <tr> <td style="text-align: center;">1</td> <td>Detects warning and limits torque by host controller. (Rotational servomotors) Detects warning and limits force by host controller. (Linear servomotors)</td> </tr> <tr> <td style="text-align: center;">2</td> <td>Detects warning and limits torque by Pn424 and Pn425. (Execution by SERVOPACK alone) (Rotational servomotors) Detects warning and limits force by Pn424 and Pn425. (Execution by SERVOPACK alone) (Linear servomotors)</td> </tr> </table>							Function Selection for Insufficient voltage		0	Disables detection of insufficient voltages.	1	Detects warning and limits torque by host controller. (Rotational servomotors) Detects warning and limits force by host controller. (Linear servomotors)	2	Detects warning and limits torque by Pn424 and Pn425. (Execution by SERVOPACK alone) (Rotational servomotors) Detects warning and limits force by Pn424 and Pn425. (Execution by SERVOPACK alone) (Linear servomotors)								
	Function Selection for Insufficient voltage																						
	0	Disables detection of insufficient voltages.																					
	1	Detects warning and limits torque by host controller. (Rotational servomotors) Detects warning and limits force by host controller. (Linear servomotors)																					
	2	Detects warning and limits torque by Pn424 and Pn425. (Execution by SERVOPACK alone) (Rotational servomotors) Detects warning and limits force by Pn424 and Pn425. (Execution by SERVOPACK alone) (Linear servomotors)																					
	<table border="1" style="width: 100%; border-collapse: collapse;"> <tr> <td colspan="2" style="background-color: #cccccc;">Warning Detection Selection</td> </tr> <tr> <td style="width: 5%; text-align: center;">0</td> <td>Detects warning.</td> </tr> <tr> <td style="text-align: center;">1</td> <td>Does not detect any warnings except A.971.</td> </tr> <tr> <td colspan="2" style="background-color: #cccccc;">Reserved (Do not change.)</td> </tr> </table>							Warning Detection Selection		0	Detects warning.	1	Does not detect any warnings except A.971.	Reserved (Do not change.)									
Warning Detection Selection																							
0	Detects warning.																						
1	Does not detect any warnings except A.971.																						
Reserved (Do not change.)																							
<table border="1" style="width: 100%; border-collapse: collapse;"> <tr> <td colspan="2" style="background-color: #cccccc;">Reserved (Do not change.)</td> </tr> </table>							Reserved (Do not change.)																
Reserved (Do not change.)																							
Pn009	Application Function Select Switch 9	0000 to 0111	–	0010	After restart	Tuning																	
	<table border="0" style="width: 100%; border-collapse: collapse;"> <tr> <td style="width: 10%;"></td> <td style="width: 10%; text-align: center;">4th digit</td> <td style="width: 10%; text-align: center;">3rd digit</td> <td style="width: 10%; text-align: center;">2nd digit</td> <td style="width: 10%; text-align: center;">1st digit</td> <td colspan="2"></td> </tr> <tr> <td>n.</td> <td style="text-align: center;"><input type="checkbox"/></td> <td style="text-align: center;"><input type="checkbox"/></td> <td style="text-align: center;"><input type="checkbox"/></td> <td style="text-align: center;"><input type="checkbox"/></td> <td colspan="2"></td> </tr> </table>								4th digit	3rd digit	2nd digit	1st digit			n.	<input type="checkbox"/>	<input type="checkbox"/>	<input type="checkbox"/>	<input type="checkbox"/>				
		4th digit	3rd digit	2nd digit	1st digit																		
	n.	<input type="checkbox"/>	<input type="checkbox"/>	<input type="checkbox"/>	<input type="checkbox"/>																		
	<table border="1" style="width: 100%; border-collapse: collapse;"> <tr> <td colspan="2" style="background-color: #cccccc;">Reserved (Do not change.)</td> </tr> <tr> <td colspan="2" style="background-color: #cccccc;">Current Control Method Selection</td> </tr> <tr> <td style="width: 5%; text-align: center;">0</td> <td>Current control method 1</td> </tr> <tr> <td style="text-align: center;">1</td> <td>Current control method 2</td> </tr> <tr> <td colspan="2" style="background-color: #cccccc;">Speed Detection Method Selection</td> </tr> <tr> <td style="width: 5%; text-align: center;">0</td> <td>Speed detection 1</td> </tr> <tr> <td style="text-align: center;">1</td> <td>Speed detection 2</td> </tr> <tr> <td colspan="2" style="background-color: #cccccc;">Reserved (Do not change.)</td> </tr> </table>							Reserved (Do not change.)		Current Control Method Selection		0	Current control method 1	1	Current control method 2	Speed Detection Method Selection		0	Speed detection 1	1	Speed detection 2	Reserved (Do not change.)	
	Reserved (Do not change.)																						
	Current Control Method Selection																						
	0	Current control method 1																					
	1	Current control method 2																					
	Speed Detection Method Selection																						
0	Speed detection 1																						
1	Speed detection 2																						
Reserved (Do not change.)																							
<table border="1" style="width: 100%; border-collapse: collapse;"> <tr> <td colspan="2" style="background-color: #cccccc;">Reserved (Do not change.)</td> </tr> </table>							Reserved (Do not change.)																
Reserved (Do not change.)																							

(cont'd)

Parameter No.	Name	Setting Range	Units	Factory Setting	When Enabled	Classification						
Pn00B	Application Function Select Switch B	0000 to 1111	–	0000	After restart	Setup						
	<div style="display: flex; align-items: center;"> <div style="margin-right: 10px;"> 4th digit 3rd digit 2nd digit 1st digit n. <input type="checkbox"/> <input type="checkbox"/> <input type="checkbox"/> <input type="checkbox"/> </div> <div> <table border="1" style="width: 100%; border-collapse: collapse;"> <tr> <th colspan="2">Parameter Display Selection</th> </tr> <tr> <td style="text-align: center;">0</td> <td>Setup parameters</td> </tr> <tr> <td style="text-align: center;">1</td> <td>All parameters</td> </tr> </table> </div> </div>						Parameter Display Selection		0	Setup parameters	1	All parameters
	Parameter Display Selection											
	0	Setup parameters										
	1	All parameters										
	<div style="display: flex; align-items: center;"> <div style="margin-right: 10px;"> <table border="1" style="width: 100%; border-collapse: collapse;"> <tr> <th colspan="2">Alarm Gr.2 Stop Method Selection</th> </tr> <tr> <td style="text-align: center;">0</td> <td>Stops the motor by setting the speed reference to "0".</td> </tr> <tr> <td style="text-align: center;">1</td> <td>Same setting as Pn001.0 (Stops the motor by applying DB or by coasting)</td> </tr> </table> </div> </div>						Alarm Gr.2 Stop Method Selection		0	Stops the motor by setting the speed reference to "0".	1	Same setting as Pn001.0 (Stops the motor by applying DB or by coasting)
	Alarm Gr.2 Stop Method Selection											
	0	Stops the motor by setting the speed reference to "0".										
	1	Same setting as Pn001.0 (Stops the motor by applying DB or by coasting)										
	<div style="display: flex; align-items: center;"> <div style="margin-right: 10px;"> <table border="1" style="width: 100%; border-collapse: collapse;"> <tr> <th colspan="2">Power Supply Method for Three-phase SERVOPACK</th> </tr> <tr> <td style="text-align: center;">0</td> <td>Three-phase power supply</td> </tr> <tr> <td style="text-align: center;">1</td> <td>Uses three-phase input specification as single-phase power supply.</td> </tr> </table> </div> </div>						Power Supply Method for Three-phase SERVOPACK		0	Three-phase power supply	1	Uses three-phase input specification as single-phase power supply.
Power Supply Method for Three-phase SERVOPACK												
0	Three-phase power supply											
1	Uses three-phase input specification as single-phase power supply.											
<div style="display: flex; align-items: center;"> <div style="margin-right: 10px;"> <table border="1" style="width: 100%; border-collapse: collapse;"> <tr> <th colspan="2">Semi-closed Encoder Usage Method (Rotational servomotors)</th> </tr> <tr> <td style="text-align: center;">0</td> <td>Uses the encoder connected to the SERVOPACK.</td> </tr> <tr> <td style="text-align: center;">1</td> <td>Uses the encoder connected to the feedback option module.</td> </tr> </table> </div> </div>						Semi-closed Encoder Usage Method (Rotational servomotors)		0	Uses the encoder connected to the SERVOPACK.	1	Uses the encoder connected to the feedback option module.	
Semi-closed Encoder Usage Method (Rotational servomotors)												
0	Uses the encoder connected to the SERVOPACK.											
1	Uses the encoder connected to the feedback option module.											
<div style="display: flex; align-items: center;"> <div style="margin-right: 10px;"> <table border="1" style="width: 100%; border-collapse: collapse;"> <tr> <th colspan="2">Reserved (Do not change.) (Linear servomotors)</th> </tr> </table> </div> </div>						Reserved (Do not change.) (Linear servomotors)						
Reserved (Do not change.) (Linear servomotors)												
Pn00C	Application Function Select Switch C	0000 to 0111	–	0000	After restart	Setup						
	<div style="display: flex; align-items: center;"> <div style="margin-right: 10px;"> 4th digit 3rd digit 2nd digit 1st digit n. <input type="checkbox"/> <input type="checkbox"/> <input type="checkbox"/> <input type="checkbox"/> </div> <div> <table border="1" style="width: 100%; border-collapse: collapse;"> <tr> <th colspan="2">Selection of Test without Motor</th> </tr> <tr> <td style="text-align: center;">0</td> <td>Disables test without motor.</td> </tr> <tr> <td style="text-align: center;">1</td> <td>Enables test without motor.</td> </tr> </table> </div> </div>						Selection of Test without Motor		0	Disables test without motor.	1	Enables test without motor.
	Selection of Test without Motor											
	0	Disables test without motor.										
	1	Enables test without motor.										
	<div style="display: flex; align-items: center;"> <div style="margin-right: 10px;"> <table border="1" style="width: 100%; border-collapse: collapse;"> <tr> <th colspan="2">Encoder Resolution for Test without Motor (Rotational servomotors)</th> </tr> <tr> <td style="text-align: center;">0</td> <td>13 bits</td> </tr> <tr> <td style="text-align: center;">1</td> <td>20 bits</td> </tr> </table> </div> </div>						Encoder Resolution for Test without Motor (Rotational servomotors)		0	13 bits	1	20 bits
Encoder Resolution for Test without Motor (Rotational servomotors)												
0	13 bits											
1	20 bits											
<div style="display: flex; align-items: center;"> <div style="margin-right: 10px;"> <table border="1" style="width: 100%; border-collapse: collapse;"> <tr> <th colspan="2">Reserved (Do not change.) (Linear servomotors)</th> </tr> </table> </div> </div>						Reserved (Do not change.) (Linear servomotors)						
Reserved (Do not change.) (Linear servomotors)												
<div style="display: flex; align-items: center;"> <div style="margin-right: 10px;"> <table border="1" style="width: 100%; border-collapse: collapse;"> <tr> <th colspan="2">Encoder Type for Test without Motor</th> </tr> <tr> <td style="text-align: center;">0</td> <td>Incremental encoder (Rotational servomotors) Incremental linear scale (Linear servomotors)</td> </tr> <tr> <td style="text-align: center;">1</td> <td>Absolute encoder (Rotational servomotors) Absolute linear scale (Linear servomotors)</td> </tr> </table> </div> </div>						Encoder Type for Test without Motor		0	Incremental encoder (Rotational servomotors) Incremental linear scale (Linear servomotors)	1	Absolute encoder (Rotational servomotors) Absolute linear scale (Linear servomotors)	
Encoder Type for Test without Motor												
0	Incremental encoder (Rotational servomotors) Incremental linear scale (Linear servomotors)											
1	Absolute encoder (Rotational servomotors) Absolute linear scale (Linear servomotors)											
<div style="display: flex; align-items: center;"> <div style="margin-right: 10px;"> <table border="1" style="width: 100%; border-collapse: collapse;"> <tr> <th colspan="2">Reserved (Do not change.)</th> </tr> </table> </div> </div>						Reserved (Do not change.)						
Reserved (Do not change.)												

(cont'd)

Parameter No.	Name	Setting Range	Units	Factory Setting	When Enabled	Classification																				
Pn00D	Application Function Select Switch D	0000 to 0001	–	0000	After restart	Setup																				
	<p>4th digit 3rd digit 2nd digit 1st digit</p> <p>n. <input type="checkbox"/> <input type="checkbox"/> <input type="checkbox"/> <input type="checkbox"/></p> <table border="1"> <tr> <th colspan="2">Stand-alone Mode (Test Operation) Selection</th> </tr> <tr> <td>0</td> <td>Enables connection with the command option module.</td> </tr> <tr> <td>1</td> <td>Disables connection with the command option module.</td> </tr> <tr> <th colspan="2">Reserved (Do not change.)</th> </tr> <tr> <th colspan="2">Reserved (Do not change.)</th> </tr> <tr> <th colspan="2">Reserved (Do not change.)</th> </tr> </table>						Stand-alone Mode (Test Operation) Selection		0	Enables connection with the command option module.	1	Disables connection with the command option module.	Reserved (Do not change.)		Reserved (Do not change.)		Reserved (Do not change.)									
	Stand-alone Mode (Test Operation) Selection																									
	0	Enables connection with the command option module.																								
	1	Disables connection with the command option module.																								
Reserved (Do not change.)																										
Reserved (Do not change.)																										
Reserved (Do not change.)																										
Pn010	Axis Address Selection (For UART/USB communications)	0000 to 007F	–	0001	After restart	Setup																				
Pn080	Application Function Select Switch 80	0000 to 1111	–	0000	After restart	Setup																				
	<p>4th digit 3rd digit 2nd digit 1st digit</p> <p>n. <input type="checkbox"/> <input type="checkbox"/> <input type="checkbox"/> <input type="checkbox"/></p> <table border="1"> <tr> <th colspan="2">Hall Sensor Selection</th> </tr> <tr> <td>0</td> <td>Enables selection.</td> </tr> <tr> <td>1</td> <td>Disables selection.</td> </tr> <tr> <th colspan="2">Motor Phase Selection</th> </tr> <tr> <td>0</td> <td>Sets phase A lead as phase sequence of U, V, W.</td> </tr> <tr> <td>1</td> <td>Sets phase B lead as phase sequence of U, V, W.</td> </tr> <tr> <th colspan="2">Reserved (Do not change.)</th> </tr> <tr> <th colspan="2">Calculation Method for Maximum Speed or Divided Output Pulses</th> </tr> <tr> <td>0</td> <td>Determines divided output pulses with fixed maximum speed.</td> </tr> <tr> <td>1</td> <td>Determines maximum speed with fixed divided output pulses.</td> </tr> </table>						Hall Sensor Selection		0	Enables selection.	1	Disables selection.	Motor Phase Selection		0	Sets phase A lead as phase sequence of U, V, W.	1	Sets phase B lead as phase sequence of U, V, W.	Reserved (Do not change.)		Calculation Method for Maximum Speed or Divided Output Pulses		0	Determines divided output pulses with fixed maximum speed.	1	Determines maximum speed with fixed divided output pulses.
	Hall Sensor Selection																									
	0	Enables selection.																								
	1	Disables selection.																								
Motor Phase Selection																										
0	Sets phase A lead as phase sequence of U, V, W.																									
1	Sets phase B lead as phase sequence of U, V, W.																									
Reserved (Do not change.)																										
Calculation Method for Maximum Speed or Divided Output Pulses																										
0	Determines divided output pulses with fixed maximum speed.																									
1	Determines maximum speed with fixed divided output pulses.																									
Pn100	Speed Loop Gain	10 to 20000	0.1 Hz	400	Immediately	Tuning																				
Pn101	Speed Loop Integral Time Constant	15 to 51200	0.01 ms	2000	Immediately	Tuning																				
Pn102	Position Loop Gain	10 to 20000	0.1/s	400	Immediately	Tuning																				
Pn103	Moment of Inertia Ratio (Rotational servomotors) Mass Ratio (Linear servomotors)	0 to 20000	1%	100	Immediately	Tuning																				
Pn104	2nd Speed Loop Gain	10 to 20000	0.1 Hz	400	Immediately	Tuning																				
Pn105	2nd Speed Loop Integral Time Constant	15 to 51200	0.01 ms	2000	Immediately	Tuning																				
Pn106	2nd Position Loop Gain	10 to 20000	0.1/s	400	Immediately	Tuning																				
Pn109	Feedforward Gain	0 to 100	1%	0	Immediately	Tuning																				
Pn10A	Feedforward Filter Time Constant	0 to 6400	0.01 ms	0	Immediately	Tuning																				

(cont'd)

Parameter No.	Name	Setting Range	Units	Factory Setting	When Enabled	Classification	
Pn10B	Application Function for Gain Select Switch	0000 to 5334	—	0000	—	—	
	<div style="display: flex; align-items: center;"> <div style="margin-right: 20px;"> <p>4th digit</p><input type="checkbox"/></div> <div style="margin-right: 20px;"> <p>3rd digit</p><input type="checkbox"/></div> <div style="margin-right: 20px;"> <p>2nd digit</p><input type="checkbox"/></div> <div style="margin-right: 20px;"> <p>1st digit</p><input type="checkbox"/></div> </div> <div style="margin-left: 20px;"> <p>n.</p> </div>						

Reserved (Do not change.)

Reserved (Do not change.)

*1. Parameter exclusive for rotational servomotors

(cont'd)

Parameter No.	Name	Setting Range	Units	Factory Setting	When Enabled	Classification
Pn139	Automatic Gain Changeover Related Switch 1	0000 to 0052	–	0000	Immediately	Tuning
	<div style="display: flex; justify-content: space-around; margin-bottom: 5px;"> 4th digit 3rd digit 2nd digit 1st digit </div> <div style="display: flex; align-items: center;"> n. <div style="display: flex; gap: 10px;"> <input type="checkbox"/> <input type="checkbox"/> <input type="checkbox"/> <input type="checkbox"/> </div> </div>	Gain Switching Selection Switch	0	Disables automatic gain selection.		
		1	Reserved (Do not change.)			
		2	Automatic gain switching pattern 1 Changes automatically 1st gain to 2nd gain when the switching condition A is satisfied. Changes automatically 2nd gain to 1st gain when the switching condition A is not satisfied.			
		Gain Switching Condition A				
		0	Positioning completion signal (/COIN) ON			
		1	Positioning completion signal (/COIN) OFF			
		2	NEAR signal (/NEAR) ON			
		3	NEAR signal (/NEAR) OFF			
		4	Position reference filter output = 0 and reference input OFF			
5		Position reference input ON				
Reserved (Do not change.)						
Reserved (Do not change.)						
Pn13D	Current Gain Level	100 to 2000	1%	2000	Immediately	Tuning
Pn140	Model Following Control Related Switch	0000 to 1121	–	0100	Immediately	Tuning
	<div style="display: flex; justify-content: space-around; margin-bottom: 5px;"> 4th digit 3rd digit 2nd digit 1st digit </div> <div style="display: flex; align-items: center;"> n. <div style="display: flex; gap: 10px;"> <input type="checkbox"/> <input type="checkbox"/> <input type="checkbox"/> <input type="checkbox"/> </div> </div>	Model Following Control Selection	0	Does not use model following control.		
		1	Uses model following control.			
		Vibration Suppression Selection				
		0	Does not perform vibration suppression.			
		1	Performs vibration suppression over the specified frequency.			
		2	Performs vibration suppression over two different kinds of frequencies.			
		Vibration Suppression Adjustment Selection				
		0	Does not adjust vibration suppression automatically using utility function.			
		1	Adjusts vibration suppression automatically using utility function.			
Reserved (Do not change.)						
Pn141	Model Following Control Gain	10 to 20000	0.1/s	500	Immediately	Tuning
Pn142	Model Following Control Gain Compensation	500 to 2000	0.1%	1000	Immediately	Tuning
Pn143	Model Following Control Bias (Forward Direction)	0 to 10000	0.1%	1000	Immediately	Tuning
Pn144	Model Following Control Bias (Reverse Direction)	0 to 10000	0.1%	1000	Immediately	Tuning
Pn145	Vibration Suppression 1 Frequency A	10 to 2500	0.1 Hz	500	Immediately	Tuning

(cont'd)

Parameter No.	Name	Setting Range	Units	Factory Setting	When Enabled	Classification						
Pn146	Vibration Suppression 1 Frequency B	10 to 2500	0.1 Hz	700	Immediately	Tuning						
Pn147	Model Following Control Speed Feedforward Compensation	0 to 10000	0.1%	1000	Immediately	Tuning						
Pn148	2nd Model Following Control Gain	10 to 20000	0.1/s	500	Immediately	Tuning						
Pn149	2nd Model Following Control Gain Compensation	500 to 2000	0.1%	1000	Immediately	Tuning						
Pn14A	Vibration Suppression 2 Frequency	10 to 2000	0.1 Hz	800	Immediately	Tuning						
Pn14B	Vibration Suppression 2 Compensation	10 to 1000	1%	100	Immediately	Tuning						
Pn14F	Reserved (Do not change.)	–	–	0011	–	–						
Pn160	Anti-Resonance Control Related Switch	0000 to 0011	–	0010	Immediately	Tuning						
	<table border="1"> <thead> <tr> <th colspan="2">Anti-Resonance Control Selection</th> </tr> </thead> <tbody> <tr> <td>0</td> <td>Does not use anti-resonance control.</td> </tr> <tr> <td>1</td> <td>Uses anti-resonance control.</td> </tr> </tbody> </table>						Anti-Resonance Control Selection		0	Does not use anti-resonance control.	1	Uses anti-resonance control.
	Anti-Resonance Control Selection											
	0	Does not use anti-resonance control.										
1	Uses anti-resonance control.											
<table border="1"> <thead> <tr> <th colspan="2">Anti-Resonance Control Adjustment Selection</th> </tr> </thead> <tbody> <tr> <td>0</td> <td>Does not adjust anti-resonance control automatically using utility function.</td> </tr> <tr> <td>1</td> <td>Adjusts anti-resonance control automatically using utility function.</td> </tr> </tbody> </table>						Anti-Resonance Control Adjustment Selection		0	Does not adjust anti-resonance control automatically using utility function.	1	Adjusts anti-resonance control automatically using utility function.	
Anti-Resonance Control Adjustment Selection												
0	Does not adjust anti-resonance control automatically using utility function.											
1	Adjusts anti-resonance control automatically using utility function.											
Reserved (Do not change.)												
Pn161	Anti-Resonance Frequency	10 to 20000	0.1 Hz	1000	Immediately	Tuning						
Pn162	Anti-Resonance Gain Compensation	1 to 1000	1%	100	Immediately	Tuning						
Pn163	Anti-Resonance Damping Gain	0 to 300	1%	0	Immediately	Tuning						
Pn164	Anti-Resonance Filter Time Constant 1 Compensation	-1000 to 1000	0.01 ms	0	Immediately	Tuning						
Pn165	Anti-Resonance Filter Time Constant 2 Compensation	-1000 to 1000	0.01 ms	0	Immediately	Tuning						

(cont'd)

Parameter No.	Name	Setting Range	Units	Factory Setting	When Enabled	Classification	
Pn170	Tuning-less Function Related Switch	0000 to 2411	–	1401	–	–	
	Tuning-less Function Selection				When Enabled	Classification	
	0	Disables tuning-less function.			After restart	Setup	
	1	Enables tuning-less function.					
	Control Method during Speed Control				When Enabled	Classification	
	0	Uses as speed control.			After restart	Setup	
	1	Uses as speed control and uses the host controller for position control.					
	Tuning-less Tuning Level				When Enabled	Classification	
	0 to 4	Sets tuning-less tuning level.			Immediately	Setup	
Tuning-less Load Level				When Enabled	Classification		
0 to 2	Sets tuning-less load level.			Immediately	Setup		
Pn181^{*2}	Mode Switch (Speed Reference)	0 to 10000	1 mm/s	0	Immediately	Tuning	
Pn182^{*2}	Mode Switch (Acceleration)	0 to 30000	1 mm/s ²	0	Immediately	Tuning	
Pn190	Reserved (Do not change.)	–	–	0010	–	–	
Pn200	Reserved (Do not change.)	–	–	0100	–	–	
Pn205^{*1}	Multi-turn Limit	0 to 65535	1 rev	65535	After restart	Setup	
Pn207	Reserved (Do not change.)	–	–	1010	–	Setup	
Pn20A^{*1}	Number of External Encoder Pitch	4 to 1048576	Pitch/rev.	32768	After restart	Setup	
Pn20E	Electronic Gear Ratio (Numerator)	1 to 1073741824 (2 ³⁰)	1	4	After restart	Setup	
Pn210	Electronic Gear Ratio (Denominator)	1 to 1073741824 (2 ³⁰)	1	1	After restart	Setup	
Pn212^{*1}	Encoder Output Pulses	16 to 1073741824 (2 ³⁰)	1 P/rev	2048	After restart	Setup	
Pn216	Reserved (Do not change.)	–	–	0	–	–	
Pn217	Average Movement Time of Position Reference	0 to 10000	0.1 ms	0	After the change and also after the motor has stopped	Setup	

*1. Parameter exclusive for rotational servomotors

*2. Parameter exclusive for linear servomotors

(cont'd)

Parameter No.	Name	Setting Range	Units	Factory Setting	When Enabled	Classification						
Pn22A ^{*1}	<div style="display: flex; justify-content: space-around; width: 100%;"> 4th digit 3rd digit 2nd digit 1st digit </div> <div style="display: flex; justify-content: space-around; width: 100%;"> n. <input type="checkbox"/> <input type="checkbox"/> <input type="checkbox"/> <input type="checkbox"/> </div> <div style="margin-top: 10px;"> <div style="border: 1px solid black; padding: 2px; margin-bottom: 2px;">Reserved (Do not change.)</div> <div style="border: 1px solid black; padding: 2px; margin-bottom: 2px;">Reserved (Do not change.)</div> <div style="border: 1px solid black; padding: 2px; margin-bottom: 2px;">Reserved (Do not change.)</div> <div style="border: 1px solid black; padding: 2px;">Speed Feedback Selection at Fully-closed Loop Control</div> <table style="width: 100%; border-collapse: collapse;"> <tr> <td style="width: 20px; text-align: center;">0</td> <td>Uses the motor encoder speed.</td> </tr> <tr> <td style="width: 20px; text-align: center;">1</td> <td>Uses external encoder speed.</td> </tr> </table> </div>	0	Uses the motor encoder speed.	1	Uses external encoder speed.							
		0	Uses the motor encoder speed.									
		1	Uses external encoder speed.									
		Pn281	Encoder Output Resolution	1 to 4096	Edge/pitch	20	After restart	Setup				
		Pn282 ^{*2}	Linear Scale Pitch	0 to 65536	0.01 μm	0	After restart	Setup				
Pn300	Reserved (Do not change.)	–	–	600	–	–						
Pn301 ^{*1}	Reserved (Do not change.)	–	–	100	–	–						
Pn302 ^{*1}	Reserved (Do not change.)	–	–	200	–	–						
Pn303 ^{*1}	Reserved (Do not change.)	–	–	300	–	–						
Pn304 ^{*1}	JOG Speed	0 to 10000	1 min ⁻¹	500	Immediately	Setup						
Pn305	Soft Start Acceleration Time	0 to 10000	1 ms	0	Immediately	Setup						
Pn306	Soft Start Deceleration Time	0 to 10000	1 ms	0	Immediately	Setup						
Pn307	Reserved (Do not change.)	–	–	40	–	–						
Pn310	<div style="display: flex; justify-content: space-around; width: 100%;"> 4th digit 3rd digit 2nd digit 1st digit </div> <div style="display: flex; justify-content: space-around; width: 100%;"> n. <input type="checkbox"/> <input type="checkbox"/> <input type="checkbox"/> <input type="checkbox"/> </div> <div style="margin-top: 10px;"> <div style="border: 1px solid black; padding: 2px;">Vibration Detection Selection</div> <table style="width: 100%; border-collapse: collapse;"> <tr> <td style="width: 20px; text-align: center;">0</td> <td>No detection</td> </tr> <tr> <td style="width: 20px; text-align: center;">1</td> <td>Outputs warning (A.911) when vibration is detected.</td> </tr> <tr> <td style="width: 20px; text-align: center;">2</td> <td>Outputs alarm (A.520) when vibration is detected.</td> </tr> </table> <div style="border: 1px solid black; padding: 2px; margin-top: 2px;">Reserved (Do not change.)</div> <div style="border: 1px solid black; padding: 2px; margin-top: 2px;">Reserved (Do not change.)</div> <div style="border: 1px solid black; padding: 2px; margin-top: 2px;">Reserved (Do not change.)</div> </div>	0	No detection	1	Outputs warning (A.911) when vibration is detected.	2	Outputs alarm (A.520) when vibration is detected.	0000 to 0002	–	0000	Immediately	Setup
		0	No detection									
		1	Outputs warning (A.911) when vibration is detected.									
		2	Outputs alarm (A.520) when vibration is detected.									
		Pn311	Vibration Detection Sensibility	50 to 500	1%	100	Immediately	Tuning				
Pn312 ^{*1}	Vibration Detection Level	0 to 5000	1 min ⁻¹	50	Immediately	Tuning						
Pn324	Moment of Inertia Calculating Start Level (Rational servomotors)	0 to 20000	1%	300	Immediately	Setup						
	Mass Calculating Start Level (Linear servomotors)											
Pn380 ^{*2}	Reserved (Do not change.)	–	–	10	–	–						
Pn381 ^{*2}	Reserved (Do not change.)	–	–	20	–	–						

*1. Parameter exclusive for rotational servomotors
 *2. Parameter exclusive for linear servomotors

(cont'd)

Parameter No.	Name	Setting Range	Units	Factory Setting	When Enabled	Classification	
Pn382 ^{*2}	Reserved (Do not change.)	–	–	30	–	–	
Pn383 ^{*2}	JOG Speed	0 to 10000	1 mm/s	50	Immediately	Setup	
Pn384 ^{*2}	Vibration Detection Level	0 to 5000	1 mm/s	10	Immediately	Tuning	
Pn385 ^{*2}	Motor Max. Speed	1 to 100	100 mm/s	50	After restart	Setup	
Pn400	Reserved (Do not change.)	–	–	30	–	–	
Pn401	1st Step 1st Torque Reference Filter Time Constant (Rotational servomotors)	0 to 65535	0.01 ms	100	Immediately	Tuning	
	1st Step 1st Force Reference Filter Time Constant (Linear servomotors)						
Pn402 ^{*1}	Forward Torque Limit	0 to 800	1%	800	Immediately	Setup	
Pn403 ^{*1}	Reverse Torque Limit	0 to 800	1%	800	Immediately	Setup	
Pn404	Reserved (Do not change.)	–	–	100	–	–	
Pn405	Reserved (Do not change.)	–	–	100	–	–	
Pn406	Reserved (Do not change.)	–	–	800	–	–	
Pn407 ^{*1}	Reserved (Do not change.)	–	–	10000	–	–	
Pn408	Torque Related Function Switch (Rotational servomotors)	0000 to 1111	–	0000	–	Setup	
	Force Related Function Switch (Linear servomotors)						
	1st Step Notch Filter Selection		When Enabled	Classification			
	0	N/A	Immediately	Setup			
	1	Uses 1st step notch filter for torque reference.					
	Reserved (Do not change.)						
	2nd Step Notch Filter Selection		When Enabled	Classification			
	0	N/A	Immediately	Setup			
	1	Uses 2nd step notch filter for torque reference.					
Friction Compensation Function Selection		When Enabled	Classification				
0	Does not use friction compensation function.	Immediately	Setup				
1	Uses friction compensation function.						
Pn409	1st Notch Filter Frequency	50 to 5000	1 Hz	5000	Immediately	Tuning	
Pn40A	1st Notch Filter Q Value	50 to 1000	0.01	70	Immediately	Tuning	
Pn40B	1st Notch Filter Depth	0 to 1000	0.001	0	Immediately	Tuning	
Pn40C	2nd Notch Filter Frequency	50 to 5000	1 Hz	5000	Immediately	Tuning	
Pn40D	2nd Notch Filter Q Value	50 to 1000	0.01	70	Immediately	Tuning	
Pn40E	2nd Notch Filter Depth	0 to 1000	0.001	0	Immediately	Tuning	

*1. Parameter exclusive for rotational servomotors

*2. Parameter exclusive for linear servomotors

(cont'd)

Parameter No.	Name	Setting Range	Units	Factory Setting	When Enabled	Classification
Pn40F	2nd Step 2nd Torque Reference Filter Frequency (Rotational servomotors)	100 to 5000	1 Hz	5000	Immediately	Tuning
	2nd Step 2nd Force Reference Filter Frequency (Linear servomotors)					
Pn410	2nd Step 2nd Torque Reference Filter Q Value (Rotational servomotors)	50 to 100	0.01	50	Immediately	Tuning
	2nd Step 2nd Force Reference Filter Q Value (Linear servomotors)					
Pn412	1st Step 2nd Torque Reference Filter Time Constant (Rotational servomotors)	0 to 65535	0.01 ms	100	Immediately	Tuning
	1st Step 2nd Force Reference Filter Time Constant (Linear servomotors)					
Pn423	Reserved (Do not change.)	–	–	0000	–	–
Pn424	Torque Limit at Main Circuit Voltage Drop (Rotational servomotors)	0 to 100	1%	50	Immediately	Setup
	Force Limit at Main Circuit Voltage Drop (Linear servomotors)					
Pn425	Release Time for Torque Limit at Main Circuit Voltage Drop (Rotational servomotors)	0 to 1000	1 ms	100	Immediately	Setup
	Release Time for Force Limit at Main Circuit Voltage Drop (Linear servomotors)					
Pn456	Sweep Torque Reference Amplitude (Rotational servomotors)	1 to 800	1%	15	Immediately	Tuning
	Sweep Force Reference Amplitude (Linear servomotors)					
Pn460	Notch Filter Adjustment Switch	0000 to 0101	–	0101	Immediately	Tuning
	Notch Filter Adjustment Selection 1					
	0 Does not adjust 1st step notch filter automatically with utility function.					
	1 Adjusts 1st step notch filter automatically with utility function.					
	Reserved (Do not change.)					
	Notch Filter Adjustment Selection 2					
	0 Does not adjust 2nd step notch filter automatically with utility function.					
	1 Adjusts 2nd step notch filter automatically with utility function.					
	Reserved (Do not change.)					
Pn480 ^{*2}	Reserved (Do not change.)	–	–	10000	–	–
Pn481 ^{*2}	Polarity Detection Speed Loop Gain	10 to 20000	0.1 Hz	400	Immediately	Tuning
Pn482 ^{*2}	Polarity Detection Speed Loop Integral Time Constant	15 to 51200	0.01 ms	3000	Immediately	Tuning
Pn483 ^{*2}	Forward Force Limit	0 to 800	1%	30	Immediately	Setup
Pn484 ^{*2}	Reverse Force Limit	0 to 800	1%	30	Immediately	Setup
Pn485 ^{*2}	Polarity Detection Reference Speed	0 to 100	1 mm/s	20	Immediately	Setup

*1. Parameter exclusive for rotational servomotors

*2. Parameter exclusive for linear servomotors

(cont'd)

Parameter No.	Name	Setting Range	Units	Factory Setting	When Enabled	Classification
Pn486 *2	Polarity Detection Reference Accel/Decel Time	0 to 100	1 ms	25	Immediately	Tuning
Pn487 *2	Polarity Detection Constant Speed Time	0 to 300	1 ms	0	Immediately	Tuning
Pn488 *2	Polarity Detection Reference Waiting Time	50 to 500	1 ms	100	Immediately	Tuning
Pn48E *2	Polarity Detection Range	1 to 65535	1 mm	10	Immediately	Tuning
Pn490 *2	Polarity Detection Load Level	0 to 20000	1%	100	Immediately	Tuning
Pn495 *2	Polarity Detection Confirmation Force Reference	0 to 200	1%	100	Immediately	Tuning
Pn498 *2	Polarity Detection Allowable Error Range	0 to 30	1 deg	10	Immediately	Tuning
Pn501 *1	Reserved (Do not change.)	–	–	10	–	–
Pn502 *1	Reserved (Do not change.)	–	–	20	–	–
Pn503 *1	Reserved (Do not change.)	–	–	10	–	–
Pn506	Brake Reference - Servo OFF Delay Time	0 to 50	10 ms	0	Immediately	Setup
Pn507 *1	Brake Reference Output Speed Level	0 to 10000	1 min ⁻¹	100	Immediately	Setup
Pn508	Waiting Time for Brake Signal when Motor Running	10 to 100	10 ms	50	Immediately	Setup
Pn509	Instantaneous Power Cut Hold Time	20 to 1000	1 ms	20	Immediately	Setup
Pn50A	Reserved (Do not change.)	–	–	8881	–	–
Pn50B	Reserved (Do not change.)	–	–	8888	–	–
Pn50E	Reserved (Do not change.)	–	–	3000	–	–
Pn50F	Reserved (Do not change.)	–	–	1200	–	–
Pn510	Reserved (Do not change.)	–	–	0000	–	–
Pn511	Reserved (Do not change.)	–	–	8468	–	–
Pn512	Reserved (Do not change.)	–	–	0000	–	–
Pn513	Reserved (Do not change.)	–	–	0000	–	–
Pn517	Reserved (Do not change.)	–	–	0000	–	–
Pn51B *1	Excessive Error Detection Level Between Servomotor and Load Position	0 to 1073741824 (2 ³⁰)	1 reference unit	1000	Immediately	Setup
Pn51E	Excessive Position Error Warning Level	10 to 100	1%	100	Immediately	Setup
Pn520	Excessive Position Error Alarm Level	1 to 1073741823 (2 ³⁰ -1)	1 reference unit	5242880	Immediately	Setup
Pn522	Reserved (Do not change.)	–	–	1	–	–
Pn524	Reserved (Do not change.)	–	–	1073741824	–	–
Pn526	Excessive Position Error Alarm Level at Servo ON	1 to 1073741823 (2 ³⁰ -1)	1 reference unit	5242880	Immediately	Setup
Pn528	Excessive Position Error Warning Level at Servo ON	10 to 100	1%	100	Immediately	Setup
Pn529 *1	Speed Limit Level at Servo ON	0 to 10000	1 min ⁻¹	10000	Immediately	Setup
Pn52A *1	Multiplier per One Fully-closed Rotation	0 to 100	1%	20	Immediately	Setup
Pn52B	Overload Warning Level	1 to 100	1%	20	Immediately	Setup
Pn52C	Derating of Base Current at Detecting Overload of Motor	10 to 100	1%	100	After restart	Setup

*1. Parameter exclusive for rotational servomotors

*2. Parameter exclusive for linear servomotors

(cont'd)

Parameter No.	Name	Setting Range	Units	Factory Setting	When Enabled	Classification																				
Pn52F	Reserved (Do not change.)	–	–	0FFF	–	–																				
Pn530	Program JOG Operation Related Switch	0000 to 0005	–	0000	Immediately	Setup																				
	<table border="1"> <thead> <tr> <th colspan="2">Program JOG Operation Related Switch</th> </tr> </thead> <tbody> <tr> <td>0</td> <td>(Waiting time Pn535 → Forward movement Pn531) × Number of times of movement Pn536</td> </tr> <tr> <td>1</td> <td>(Waiting time Pn535 → Reverse movement Pn531) × Number of times of movements Pn536</td> </tr> <tr> <td>2</td> <td>(Waiting time Pn535 → Forward movement Pn531) × Number of times of movements Pn536 (Waiting time Pn535 → Reverse movement Pn531) × Number of times of movements Pn536</td> </tr> <tr> <td>3</td> <td>(Waiting time Pn535 → Reverse movement Pn531) × Number of times of movements Pn536 (Waiting time Pn535 → Forward movement Pn531) × Number of times of movements Pn536</td> </tr> <tr> <td>4</td> <td>(Waiting time Pn535 → Forward movement Pn531 → Waiting time Pn535 → Reverse movement Pn531) × Number of times of movement Pn536</td> </tr> <tr> <td>5</td> <td>(Waiting time Pn535 → Reverse movement Pn531 → Waiting time Pn535 → Forward movement Pn531) × Number of times of movement Pn536</td> </tr> <tr> <td colspan="2">Reserved (Do not change.)</td> </tr> <tr> <td colspan="2">Reserved (Do not change.)</td> </tr> <tr> <td colspan="2">Reserved (Do not change.)</td> </tr> </tbody> </table>						Program JOG Operation Related Switch		0	(Waiting time Pn535 → Forward movement Pn531) × Number of times of movement Pn536	1	(Waiting time Pn535 → Reverse movement Pn531) × Number of times of movements Pn536	2	(Waiting time Pn535 → Forward movement Pn531) × Number of times of movements Pn536 (Waiting time Pn535 → Reverse movement Pn531) × Number of times of movements Pn536	3	(Waiting time Pn535 → Reverse movement Pn531) × Number of times of movements Pn536 (Waiting time Pn535 → Forward movement Pn531) × Number of times of movements Pn536	4	(Waiting time Pn535 → Forward movement Pn531 → Waiting time Pn535 → Reverse movement Pn531) × Number of times of movement Pn536	5	(Waiting time Pn535 → Reverse movement Pn531 → Waiting time Pn535 → Forward movement Pn531) × Number of times of movement Pn536	Reserved (Do not change.)		Reserved (Do not change.)		Reserved (Do not change.)	
	Program JOG Operation Related Switch																									
	0	(Waiting time Pn535 → Forward movement Pn531) × Number of times of movement Pn536																								
	1	(Waiting time Pn535 → Reverse movement Pn531) × Number of times of movements Pn536																								
	2	(Waiting time Pn535 → Forward movement Pn531) × Number of times of movements Pn536 (Waiting time Pn535 → Reverse movement Pn531) × Number of times of movements Pn536																								
	3	(Waiting time Pn535 → Reverse movement Pn531) × Number of times of movements Pn536 (Waiting time Pn535 → Forward movement Pn531) × Number of times of movements Pn536																								
	4	(Waiting time Pn535 → Forward movement Pn531 → Waiting time Pn535 → Reverse movement Pn531) × Number of times of movement Pn536																								
	5	(Waiting time Pn535 → Reverse movement Pn531 → Waiting time Pn535 → Forward movement Pn531) × Number of times of movement Pn536																								
Reserved (Do not change.)																										
Reserved (Do not change.)																										
Reserved (Do not change.)																										
Pn531	Program JOG Movement Distance	1 to 1073741824 (2 ³⁰)	1 reference unit	32768	Immediately	Setup																				
Pn533^{*1}	Program JOG Movement Speed	1 to 10000	1 min ⁻¹	500	Immediately	Setup																				
Pn534	Program JOG Acceleration/Deceleration Time	2 to 10000	1 ms	100	Immediately	Setup																				
Pn535	Program JOG Waiting Time	0 to 10000	1 ms	100	Immediately	Setup																				
Pn536	Number of Times of Program JOG Movement	0 to 1000	1 time	1	Immediately	Setup																				
Pn550	Analog Monitor 1 Offset Voltage	-10000 to 10000	0.1 V	0.0	Immediately	Setup																				
Pn551	Analog Monitor 2 Offset Voltage	-10000 to 10000	0.1 V	0.0	Immediately	Setup																				
Pn552	Analog Monitor Magnification (×1)	-10000 to 10000	×0.01	100	Immediately	Setup																				
Pn553	Analog Monitor Magnification (×2)	-10000 to 10000	×0.01	100	Immediately	Setup																				
Pn560	Remained Vibration Detection Width	1 to 3000	0.1%	400	Immediately	Setup																				
Pn561	Overshoot Detection Level	0 to 100	1%	100	Immediately	Setup																				
Pn580^{*2}	Reserved (Do not change.)	–	–	10	–	–																				
Pn581^{*2}	Reserved (Do not change.)	–	–	20	–	–																				
Pn582^{*2}	Reserved (Do not change.)	–	–	10	–	–																				
Pn583^{*2}	Brake Reference Output Speed Level	0 to 10000	1 mm/s	10	Immediately	Setup																				
Pn584^{*2}	Speed Limit Level at Servo ON	0 to 10000	1 mm/s	10000	Immediately	Setup																				
Pn585^{*2}	Program JOG Movement Speed	1 to 10000	1 mm/s	50	Immediately	Setup																				

*1. Parameter exclusive for rotational servomotors

*2. Parameter exclusive for linear servomotors

(cont'd)

Parameter No.	Name	Setting Range	Units	Factory Setting	When Enabled	Classification												
Pn586 *2	Motor Running Air-cooling Ratio	0 to 100	1%/maxvel	0	Immediately	Setup												
Pn587 *2	Polarity Detection for Absolute Scale Selection	0000 to 0001	–	0000	Immediately	Setup												
	<p>n. <input type="checkbox"/> <input type="checkbox"/> <input type="checkbox"/> <input type="checkbox"/></p> <p>4th digit 3rd digit 2nd digit 1st digit</p> <table border="1"> <tr> <td colspan="2">Polarity Detection for Absolute Scale Selection</td> </tr> <tr> <td>0</td> <td>Does not detect polarity.</td> </tr> <tr> <td>1</td> <td>Detects polarity.</td> </tr> <tr> <td colspan="2">Reserved (Do not change.)</td> </tr> <tr> <td colspan="2">Reserved (Do not change.)</td> </tr> <tr> <td colspan="2">Reserved (Do not change.)</td> </tr> </table>						Polarity Detection for Absolute Scale Selection		0	Does not detect polarity.	1	Detects polarity.	Reserved (Do not change.)		Reserved (Do not change.)		Reserved (Do not change.)	
	Polarity Detection for Absolute Scale Selection																	
	0	Does not detect polarity.																
	1	Detects polarity.																
Reserved (Do not change.)																		
Reserved (Do not change.)																		
Reserved (Do not change.)																		
Pn600	Regenerative Resistor Capacity *3	Depends on SERVOPACK Capacity*4	10 W	0	Immediately	Setup												
Pn601	Reserved (Do not change.)	–	–	0	–	–												
Pn800 to Pn95F	Reserved (Do not change.)	–	–	0	–	–												

*2. Parameter exclusive for linear servomotors

*3. Normally set to "0." When using an external regenerative resistor, set the capacity (W) of the regenerative resistor.

*4. The upper limit is the maximum output capacity (W) of the SERVOPACK.

10.3 Monitor Modes

The following list shows monitor modes available.

Un No.	Content of Display	Unit	Serial Command
Un000	Motor rotating speed (Rotation servomotors)	min ⁻¹	NFB
	Motor movement speed (Linear servomotors)	mm/s	
Un001	Not used	—	—
Un002	Internal torque reference (in percentage to the rated torque)	%	TREF
Un003	Electrical angle 1	pulse (encoder resolution) ^{*1}	—
Un004	Electrical angle 2 (electric angle from polarity origin)	deg	—
Un005 ^{*1}	Input signal monitor	—	IN1
Un006 ^{*1}	Output signal monitor	—	OUT1
Un007	Input Reference speed (Rotational servomotors)	min ⁻¹	NREF
	Input Reference speed (Linear servomotors)	mm/s	
Un008	Position error amount	reference unit	PER
Un009	Accumulated load ratio (in percentage to the rated torque: effective torque in cycle of 10 seconds)	%	TRMS
Un00A	Regenerative load ratio (in percentage to the processable regenerative power: regenerative power consumption in cycle of 10 seconds)	%	RGRMS
Un00B	Power consumed by DB resistance (in percentage to the processable power at DB activation: display in cycle of 10 seconds)	%	DBRMS
Un00C	Input Reference counter	reference unit	—
Un00D	Feedback pulse counter	pulse (encoder resolution) ^{*1}	—
Un00E	Fully-closed feedback pulse counter	pulse (encoder resolution) ^{*1}	—
Un011	Hall sensor signal monitor	—	HALLSENS
Un012	Total operation time	100 ms	—
Un013	Feedback pulse counter	reference unit	—
Un014	Effective gain monitor (gain setting 1 = 1, gain setting 2 = 2)	—	—
Un015	Safety I/O signal monitor	—	—
Un020	Motor rated rotational speed (Rotational servomotors)	min ⁻¹	—
	Motor rated speed (Linear servomotors)	mm/s	
Un021	Motor maximum rotational speed (Rotational servomotors)	min ⁻¹	—
	Motor maximum speed (Linear servomotors)	mm/s	
Un084	Linear scale pitch ^{*2}	µm	—
Un085	Linear scale pitch index ^{*2}	—	—

*1. For details, refer to the following manuals.

- *ΣV Series User's Manual Design and Maintenance Rotational Motor/Command Option Attachable Type* (SIEP S800000 60).
- *ΣV Series User's Manual Design and Maintenance Linear Motor/Command Option Attachable Type* (SIEP S800000 66).

*2. Scale pitch = Un084 × 10^{Un085} [µm]

10.4 Utility Functions

The following table lists the available utility functions.

The following utility functions can be executed from a digital operator.

Fn No.	Function	Operation from the Digital Operator	Operation from the Serial Commands	Operation from the SigmaWin+
Fn000	Alarm history display	×	○ (ALMn)	○
Fn002	JOG operation	○	×	○
Fn003	Origin search	○	×	○
Fn004	Program JOG operation	○	×	○
Fn005	Initializing parameter settings	×	○ (PRMINIT)	○
Fn006	Clearing alarm history	×	○ (ALMTRCCLR)	○
Fn008	Absolute encoder multi-turn reset and encoder alarm reset	○	○ (ABSPGRES)	○
Fn00C	Offset adjustment of analog monitor output	○	×	○
Fn00D	Gain adjustment of analog monitor output	○	×	○
Fn00E	Automatic offset-signal adjustment of motor current detection	○	○ (CURZERO)	○
Fn00F	Manual offset-signal adjustment of motor current detection	○	×	○
Fn010	Write prohibited setting	○	×	○
Fn011	Servomotor model display	○	○ (MTTYPE, MTSIZE, PGTYPE, SVSPEC)	○
Fn012	Software version display	○	○ (SVVER, PGVER, VER)	○
Fn013	Multi-turn limit value setting change when a multi-turn limit disagreement alarm (A.CC0) occurs	○	○ (MLTLIMSET)	○
Fn014	Resetting configuration error of option module	○	×	○
Fn01B	Vibration detection level initialization	○	×	○
Fn01E	Display of SERVOPACK and servomotor ID	○	○ (TYPE)	○
Fn01F	Display of servomotor ID in feedback option module	×	×	×
Fn020	Origin setting	○	×	○
Fn030	Software reset	○	×	○
Fn080	Polarity detection	○	×	○
Fn200	Tuning-less level setting	○	×	○
Fn201	Advanced autotuning	○	×	○
Fn202	Advanced autotuning by reference	○	×	○
Fn203	One-parameter tuning	○	×	○
Fn204	Anti-resonance control adjustment function	○	×	○
Fn205	Vibration suppression function	○	×	○
Fn206	EasyFFT	○	×	○
Fn207	Online vibration monitor	○	×	○
FnB03*	Program table edit/save	○	○ (PGMSTORE)	○
FnB04*	ZONE table edit/save	○	○ (ZONESTORE)	○
FnB05*	JOG speed table edit/save	○	○ (JSPDSTORE)	○

(cont'd)

Fn No.	Function	Operation from the Digital Operator	Operation from the Serial Commands	Operation from the SigmaWin+
FnB06*	Program table initialization	○	○ (PRMINIT)	○
FnB07*	ZONE table initialization	○	○ (ZONEINIT)	○
FnB08*	JOG speed table initialization	○	○ (JSPDINIT)	○
FnB09*	Absolute encoder origin setting	○	○ (ZSET)	×
FnB0A*	INDEXER status monitor	○	○ (ALM, ERR, IN2, OUT2, STS, PUN, PFB, POS, DST, RPOS, RDST, PGM-STEP, EVTIME, LOOP)	○
FnB0B*	INDEXER parameter setting initialization	○	○ (PRMINIT)	○
FnB0C*	INDEXER alarm reset	○	○ (ARES, ALMTRC-CLR)	○
FnB0D*	INDEXER alarm history display	○	○ (ALMn)	○

○: Available ×: Not available

* These functions are available for the following software versions.

INDEXER module: Version 3 or later

SERVOPACK: Version 001B or later.

Note: A setting may be write-prohibited if the digital operator displays “NO-OP” when any of the above utility function is executed. For details, refer to the following manuals.

- *ΣV Series User's Manual Design and Maintenance Rotational Motor/Command Option Attachable Type* (SIEP S800000 60).
- *ΣV Series User's Manual Design and Maintenance Linear Motor/Command Option Attachable Type* (SIEP S800000 66).

10.5 Alphabetical List of Serial Commands

The following table lists the usable serial commands in alphabetical order. For more details on the serial commands, refer to 7.7 *Serial Commands*.

Serial Command	Function	Reference
ABSPGRES	Absolute Encoder Reset	7.7.8
ACCnnnnnnnn	Acceleration Specification	7.7.2
ACCTsss	Program Table ACC Read	7.7.4
ACCTsss=	Program Table ACC Write	7.7.4
ALM	Alarm or Warning Read	7.7.8
ALMn	Alarm History Read	7.7.8
ALMTRCLR	Alarm Trace Clear	7.7.8
ARES	Alarm Reset	7.7.1
CURZERO	Motor Current Zero Adjustment	7.7.8
DBRMS	Dynamic-Brake Load Ratio Monitor	7.7.8
DECnnnnnnnn	Deceleration Specification	7.7.2
DECTsss	Program Table DEC Read	7.7.4
DECTsss=	Program Table DEC Write	7.7.4
DST or MON9	Target Distance Monitor	7.7.8
ERR	Most Recent Error Read	7.7.8
EVENTTsss	Program Table EVENT Read	7.7.4
EVENTTsss=	Program Table EVENT Write	7.7.4
EVTIME	Program EVENT Elapsed Time Monitor	7.7.8
HALLSENS	Hall Sensor Monitor For Linear Servomotors	7.7.8
HOLD	Positioning Interruption	7.7.2
IN1	SERVOPACK Input Signal Monitor (CN1)	7.7.8
IN2	INDEXER Module Input Signal Monitor (CN11)	7.7.8
IN2TESTbbbbbbbb	INDEXER Module Input Signal Specification (CN11)	7.7.8
IN3	Safety Function Input Signal Monitor	7.7.8
JOGPnnnnnnnn	JOG Forward	7.7.2
JOGNnnnnnnnn	JOG Reverse	7.7.2
JSPDINIT	JOG Speed Table Initialization	7.7.7
JSPDSTORE	JOG Speed Table Save	7.7.7
JSPDTdd	JOG Speed Table Read	7.7.7
JSPDTdd=	JOG Speed Table Write	7.7.7
LOOP	Program Table LOOP Pass Through Monitor	7.7.8
LOPTsss	Program Table LOOP Read	7.7.4
LOPTsss=	Program Table LOOP Write	7.7.4
MLTLIMSET	Multi-turn Limit Setting	7.7.8
MONn	Monitor Read	7.7.8
MTSIZE	Monitor Capacity Display	7.7.8
MTTYPE	Motor Model Code Display	7.7.8
NEXTTsss	Program Table NEXT Read	7.7.4
NEXTTsss=	Program Table NEXT Write	7.7.4
NFB or MON3	Motor Speed Monitor	7.7.8
NREF or MON4	Speed Reference Monitor	7.7.8
OUT1	SERVOPACK Output Signal Monitor (CN1)	7.7.8

(cont'd)

Serial Command	Function	Reference
OUT2	INDEXER Module Output Signal Monitor (CN11)	7.7.8
OUT2TESTbbbbbbbbb	INDEXER Module Output Signal Specification (CN11)	7.7.8
PER or MON2	Position Error Monitor	7.7.8
PFB or MON7	Current (Actual) Motor Position Monitor	7.7.8
PGMINIT	Program Table Initialization	7.7.4
PGMRES	Program Table Operation Reset	7.7.5
PGMSTEP	Program Step (PGMSTEP) Monitor	7.7.8
PGMSTORE	Program Table Save	7.7.4
PGTYPE	Encoder Model Code Display	7.7.8
PGVER	Encoder Firmware Version Display	7.7.8
POS (\pm) nnnnnnnn POSA (\pm) nnnnnnnn	Target Position Specification (Absolute Position)	7.7.2
POS or MON8	Target Position Monitor	7.7.8
POSI (\pm) nnnnnnnn	Target Position Specification (Relative Distance)	7.7.2
POSTsss	Program Table POS Read	7.7.4
POSTsss=	Program Table POS Write	7.7.4
POUT	POUT Monitor	7.7.8
POUTnnnnnnnn	POUT Specification	7.7.2
POUTTsss	Program Table POUT Read	7.7.4
POUTTsss=	Program Table POUT Write	7.7.4
PRMINIT	Parameter Initialization	7.7.3
PRMppp	Parameter Read	7.7.3
PRMppp=	Parameter Write	7.7.3
PUN or MON1	Current Distributed Position Monitor	7.7.8
RDST or MON11	Registration Target Distance Monitor	7.7.8
RDSTnnnnnnnn	Registration Distance Specification	7.7.2
RDSTTsss	Program Table RDST Read	7.7.4
RDSTTsss=	Program Table RDST Write	7.7.4
RES	Reset	7.7.1
RGRMS	Regeneration Load Ratio Monitor	7.7.8
RPOS or MON10	Registration Target Position Monitor	7.7.8
RS	Positioning Start with Registration	7.7.2
RS (\pm) nnnnnnnn RSA (\pm) nnnnnnnn	Positioning Start with Registration (Absolute Position)	7.7.2
RSI (\pm) nnnnnnnn	Positioning Start with Registration (Relative Distance)	7.7.2
RSPDnnnnnnnn	Registration Speed Specification	7.7.2
RSPDTsss	Program Table RSPD Read	7.7.4
RSPDTsss=	Program Table RSPD Write	7.7.4
SKIP	Positioning Stop	7.7.2
SPDnnnnnnnn	Positioning Speed Specification	7.7.2
SPDTsss	Program Table SPD Read	7.7.4
SPDTsss=	Program Table SPD Write	7.7.4
ST	Positioning Start	7.7.2
ST (\pm) nnnnnnnn STA (\pm) nnnnnnnn	Positioning Start (Absolute Position)	7.7.2
START	Program Table Operation Restart	7.7.5

(cont'd)

Serial Command	Function	Reference
STARTsss	Program Table Operation Start	7.7.5
STI (\pm) nnnnnnnn	Positioning Start (Relative Position)	7.7.2
STOP	Program Table Operation Interruption	7.7.5
STS or MON6	Status Flag Monitor	7.7.8
SVOFF	Servo OFF	7.7.1
SVON	Servo ON	7.7.1
SVTYPE	SERVOPACK Model Code Display	7.7.8
SVVER	SERVOPACK Firmware Version Display	7.7.8
SVYSPEC	SERVOPACK Special Specification No. Display	7.7.8
TREF or MON5	Internal Torque Reference Monitor	7.7.8
TRMppp=	Temporary Parameter Write	7.7.3
TRMS	Cumulative Load Ratio Monitor	7.7.8
TYPE	INDEXER Module Model Code Display	7.7.8
VER	INDEXER Module Firmware Version Display	7.7.8
YSPEC	INDEXER Module Special Specification No. Display	7.7.8
ZONEINIT	Zone Table Initialization	7.7.6
ZONENTzz	Zone Table ZONEN Read	7.7.6
ZONENTzz=	Zone Table ZONEN Write	7.7.6
ZONEPTzz	Zone table ZONEP Read	7.7.6
ZONEPTzz=	Zone Table ZONEP Write	7.7.6
ZONESTORE	Zone Table Save	7.7.6
ZRN	Homing Start	7.7.2
ZSET (\pm) nnnnnnnn	Coordinates Setting	7.7.2

10.6 Parameter Equivalence List for INDEXER Modules for SGDV SERVOPACKs and INDEXER Modules for SGDH SERVOPACKs

The equivalence list for INDEXER Modules (SGDV-OCA03A) for SGDV SERVOPACKs and INDEXER Modules (NS600) for SGDH SERVOPACKs is presented below.

Parameter Name	SGDV-OCA03A Parameter No.	NS600 Parameter No.
Axis Address Selection	Pn010 (setting range: 1 to F)	Rotary Switch (ADRS)
Serial Communication Protocol	PnB00	Pn800
Bit rate	PnB01	Pn801
Response "OK"	PnB02	Pn802
/MODE 0/1	PnB03	Pn803
/START-STOP; /HOME	PnB04	Pn804
/PGMRES; /JOGP	PnB05	Pn805
/SEL0; /JOGN	PnB06	Pn806
/SEL1; /JOG0	PnB07	Pn807
/SEL2; /JOG1	PnB08	Pn808
/SEL3; /JOG2	PnB09	Pn809
/SEL4; /JOG3	PnB0A	Pn80A
/SEL5	PnB0B	Pn833
/SEL6	PnB0C	Pn834
/SEL7	PnB0D	–
/S-ON	PnB0E	Pn80B
P-OT	PnB0F	Pn80C
N-OT	PnB10	Pn80D
/DEC	PnB11	Pn80E
/RGRT	PnB12	Pn80F
/INPOSITION	PnB13	Pn810
/POUT0	PnB14	Pn811
/POUT1	PnB15	Pn812
/POUT2	PnB16	Pn813
/POUT3	PnB17	Pn814
/POUT4	PnB18	Pn815
/POUT5	PnB19	–
/POUT6	PnB1A	–
/POUT7	PnB1B	–
/WARN	PnB1C	Pn816
/BK	PnB1D	Pn817
/S-RDY	PnB1E	Pn818
Overtravel (OT) Stop Method	PnB1F	Pn819
Moving Mode	PnB20	Pn81A
Linear Type (PnB20 = 0): Forward Software Limit (P-LS) Rotary Type (PnB20 ≠ 0): End Point of Rotational Coordinates	PnB21 (PnB22)	Pn81B

(cont'd)

Parameter Name	SGDV-OCA03A Parameter No.	NS600 Parameter No.
Linear Type (PnB20 = 0): Reverse Software Limit (N-LS) Rotary Type (PnB20 ≠ 0): Starting Point of the Rotational Coordinates	PnB23 (PnB24)	Pn81C
Origin (Incremental Encoder) Absolute Encoder Offset (Absolute Encoder)	PnB25 (PnB26)	Pn81D
Positioning/Registration Speed	PnB27 (PnB28)	Pn81E
Acceleration rate	PnB29 (PnB2A)	Pn81F
Deceleration rate	PnB2B (PnB2C)	Pn820
/INPOSITION Width	PnB2D (PnB2E)	Pn821
/NEAR Width	PnB2F (PnB30)	Pn822
Homing Method	PnB31	Pn823
Homing Direction	PnB32	Pn824
Homing Moving Speed	PnB33 (PnB34)	Pn825
Homing Approach Speed	PnB35 (PnB36)	Pn826
Homing Creep Speed	PnB37 (PnB38)	Pn827
Homing Final Move Distance	PnB39 (PnB3A)	Pn828
Reserved (setup information)	PnB3B (PnB3C)	Pn829
Reserved (setup information)	PnB3D (PnB3E)	Pn82A
Reserved (setup information)	PnB3F (PnB40)	Pn82B
Reserved (setup information)	PnB41 (PnB42)	Pn82C
Reserved (setup information)	PnB43 (PnB44)	Pn82D
Reserved (setup information)	PnB45 (PnB46)	Pn82E
Reserved (setup information)	PnB47 (PnB48)	Pn82F
Reserved (setup information)	PnB49 (PnB4A)	Pn830
Reserved (setup information)	PnB4B (PnB4C)	Pn831
Reserved (setup information)	PnB4D (PnB4E)	Pn832
ZONE Signal Setting	PnB4F	Pn835
Backlash Compensation	PnB50	Pn836
/ALO Output Selection	PnB51	–
/ALM-RST	PnB52	–
Input Signal Monitor IN1 Polarity Selection	PnB53	–

Index

Symbols

* (global address)	7-5
+24V/COM	4-12
+24VIN	4-10

A

absolute encoder	7-17, 7-18
offset	5-18
origin setting	8-19
reset	7-35
ACC	6-6
acceleration	5-14, 6-6, 7-10
alarm code output signal	5-7
alarm reset	7-8, 8-25
alarm reset capability	9-2
alarm reset method	5-7
alarm stopping method	9-2
alarms	5-7
INDEXER Module alarm displays and troubleshooting	9-9
list of alarms for SERVOPACKs	9-2
servo alarm output signal	5-7
status displays	9-2
ALM	4-11, 5-7
/ALM-RST	4-10, 5-7
/ALO1 to /ALO3	5-7
altitude	2-4, 3-2
ambient humidity	2-4, 3-2
applicable SERVOPACK	2-4
applicable standards	xiii, 3-2
average movement time of position references	5-14
axis address	7-3
setting	7-3
axis address selection	10-33
axis number	7-4, 7-5, 7-7, 7-8

B

backlash compensation	5-19
base-mounted	3-3
BAT	4-10
bit rate	7-2, 7-3, 7-6
/BK	4-11, 5-8

C

clear hold	7-10, 7-13, 7-15, 7-16
CN1	
I/O signal connector (CN1, CN8) connection example	4-15
CN11	
I/O signal connector	2-5
CN12	
serial command communications connector	2-5, 4-17
specifications	7-2
CN8	
I/O signal connector (CN1, CN8) connection example	4-15
coast to a stop	5-6
commands	7-4, 7-6, 7-7
command/response format	7-4
connector	
I/O signal connector	2-5
serial command communications connector CN12	4-17
continuous stop	6-5, 6-18

cooling	3-4
coordinates	
coordinates setting	7-17, 7-18
moving mode and coordinate settings	5-16
corrosive gas	3-2
cursor	iii, 8-3

D

/DEC	4-10, 6-27, 7-16
DEC	6-6
deceleration	5-14, 6-6, 7-10
delimiter	7-4, 7-5, 7-6, 7-8
DEN	6-7, 6-8
digital operator	8-1
DTR/DSR control	7-2
duct-ventilated	3-3
dynamic brake	5-6

E

echoback	7-4, 7-6
echoback response time	7-6
electronic gear	5-13
electronic gear ratio setting	5-13
EMC directive	xiii, 3-2
EMC installation conditions	3-5
encoder signal outputs	5-12
error/warning output signal	5-9
errors	
INDEXER Module error displays and troubleshooting	9-14
status displays	9-14
European Standards	xiii
EVENT	6-7, 6-8, 6-11
EVENT condition examples	6-8

F

FG	4-11
framing error	7-7
full-duplex wiring	4-19, 7-2, 7-4, 7-6

G

global commands	7-5
Gr.1	9-2
Gr.2	9-2

H

half-duplex wiring	4-19, 7-2, 7-4, 7-6
hall sensor	7-34
/HOME	4-12, 4-16, 6-27, 6-30
home position setting	5-18
homing	6-24, 6-30
homing operation	6-27
homing start	7-16
homing/JOG speed table input signals	6-24
input conditions	6-30
input signal timing specifications	6-30
parameters related to homing	6-26

I

I/O signals	
connection example	4-15
input signals	4-10
names and functions	4-10
output signals	4-11
incremental encoder	7-18

- INDEXER
 alarm history display ----- 8-27
 clearing the alarm history ----- 8-25
 parameter setting initialization ----- 8-24
 resetting alarms ----- 8-25
 status monitor ----- 8-21
- INDEXER Module
 general specifications ----- 2-4
 nameplate ----- 1-3
 part names ----- 2-5
 specifications ----- 2-1
- INFINITE ----- 6-5, 6-17
 /INPOSITION ----- 4-13, 4-15, 5-10, 6-7, 6-8
 installation conditions ----- 3-2
 interfaces with output circuits ----- 4-14
 interfaces with sequence input circuits ----- 4-14
- J**
- JOG forward/reverse ----- 7-14
 JOG speed table ----- 6-24, 6-28, 6-30, 7-30
 homing/JOG speed table input signals ----- 6-24
 input conditions ----- 6-30
 input signal timing specifications ----- 6-30
 JOG speed table edit ----- 8-14
 JOG speed table initialization ----- 8-18
 JOG speed table operation ----- 6-27, 6-28
 JOG speed table save ----- 8-15
 JOG speed table setup commands ----- 7-30
 /JOG0 to /JOG3 ----- 4-12, 4-15, 6-28
 /JOGN ----- 4-12, 4-15, 6-27, 6-28, 6-30
 /JOGP ----- 4-12, 4-15, 6-27, 6-28, 6-30
- L**
- latch ----- 6-19, 6-20, 6-21, 7-12, 7-15
 latch signal ----- 6-21
 latch timing ----- 6-19
 LED indicators ----- 2-5, 2-6
 LOOP ----- 6-7
 low voltage directive ----- xiii, 3-2
- M**
- Mode 0 ----- 6-2
 /MODE 0/1 ----- 4-12, 4-15, 6-2, 6-3, 6-11, 6-24, 6-30
 Mode 1 ----- 6-24
 mode switch signal ----- 6-2
 model designation ----- 1-3
 monitor
 monitor and utility function commands ----- 7-31
 monitor modes ----- 10-27
 moving mode and coordinate settings ----- 5-16
 multiturn limit setting ----- 7-35
- N**
- NEAR ----- 6-7, 6-8
 negative responses ----- 7-7
 NEXT ----- 6-5, 6-7
 noise filter ----- 3-10, 3-11
 North American Safety Standards ----- xiii
 N-OT ----- 4-10, 5-5
 number of executions ----- 6-7
- O**
- OK ----- 7-3, 7-7
 structure of the response OK ----- 7-7
 overrun error ----- 7-7
 overtravel ----- 5-5, 7-17
- overtravel setting ----- 5-5
- P**
- parameter setting and functions ----- 5-1
 parameters
 parameter edit commands ----- 7-22
 parameter equivalence list ----- 10-33
 parameter list for INDEXER Module ----- 10-2
 parameter list for SERVOPACKs ----- 10-10
 restrictions on SGD V SERVOPACK parameters ----- 5-3
 parity ----- 7-2
 parity error ----- 7-7
 /PGMRES ----- 4-12, 4-15, 6-3, 6-11
 PGMSTEP ----- 6-4, 6-5, 6-7, 6-9
 photocoupler output circuit ----- 4-14
 placement ----- 2-4
 pollution degree ----- 2-4, 3-2
 POS ----- 6-5
 position error ----- 5-10
 positioning ----- 6-5
 positioning completed output ----- 5-10
 positioning completed output signal ----- 5-10
 positioning interruption ----- 7-19
 positioning speed ----- 5-14, 6-5, 7-9
 positioning start ----- 7-10, 7-11
 positioning stop ----- 7-20
 positioning table ----- 6-16
 target position ----- 6-5, 7-9
 positioning start ----- 7-10
 positioning start with registration ----- 7-14
 positive responses ----- 7-7
 P-OT ----- 4-10, 5-5
 POUT, POUT0 to POUT7 ----- 6-6, 7-21
 /POUT0 to /POUT7 ----- 4-13, 4-15, 5-11, 6-6, 6-23, 7-21
 power loss
 power loss in the INDEXER Module ----- 4-21
 power specifications ----- 2-4
 power supply method ----- 2-4
 product overview ----- 2-2
 program ----- 6-2, 6-5, 6-9, 7-24, 7-28
 input signal timing specifications for program table operation ----- 6-11
 input signals for program table operation ----- 6-2
 program step ----- 6-5
 program table ----- 5-11, 6-2, 6-5
 program table edit ----- 8-6
 program table examples ----- 6-13
 program table initialization ----- 8-16
 program table method ----- 2-4
 program table operation ----- 6-7, 6-9, 6-10
 program table operation commands ----- 7-28
 program table save ----- 8-10
 program table settings ----- 6-5
 program table setup commands ----- 7-24
 program table step selection ----- 6-4
 resetting the program ----- 6-10
 restarting the program ----- 6-9
 starting and stopping the program ----- 6-9
 status changes in program table operation ----- 6-10
 stopping the program ----- 6-9
 programmable output signal ----- 5-11, 6-6, 6-23, 7-21
 protection class ----- 2-4, 3-2
 protocol ----- 7-3

R

rack-mounted	3-3
RDST	6-5, 6-20
reference units	5-13
region indicating signal	6-22
registration	6-17, 6-19, 6-20
JOG forward/reverse with registration	7-15
positioning start with registration	7-13
registration distance	6-5, 6-20, 7-12
registration input setting	6-20
registration latch signal	6-20
registration operation	6-20
registration speed	6-6, 7-12
registration timing specifications	6-19
response	7-3, 7-4, 7-5, 7-7, 7-8
command/response format	7-4
OK response	7-3
response data details	7-7
/RGRT	4-10, 6-20, 7-12, 7-15
RS-422	4-17, 4-20, 7-2
RS-485	4-17, 4-20, 7-2
RSPD	6-6
RTS/CTS control	7-2

S

/SEL0 to /SEL7	4-12, 4-15, 6-3, 6-4, 6-7, 6-8, 6-9, 6-11
serial commands	6-3, 7-1, 7-8
alphabetical list	10-30
command/response format	7-4
parameters related to serial communications	7-3
serial command communications	7-1
serial communications method	2-4
servo alarm output signal	5-7
Servo OFF	7-8
Servo ON	7-8
servo ON/OFF input signal	5-5
servo ready output signal	5-9
SERVOPACK	
EMC installation conditions	3-5
installation conditions for applicable standards	3-2
installation environment	3-2
installation precautions	3-2
installation standards	3-4
orientation	3-3
system configuration diagram	
(SGDV-□□□AE1A SERVOPACK)	4-3
system configuration diagram	
(SGDV-□□□AE5A SERVOPACK)	4-7
system configuration diagram	
(SGDV-□□□DE1A SERVOPACK)	4-5
system configuration diagram	
(SGDV-□□□DE5A SERVOPACK)	4-9
system configuration diagram	
(SGDV-□□□FE1A SERVOPACK)	4-2
system configuration diagram	
(SGDV-□□□FE5A SERVOPACK)	4-6
SERVOPACK orientation	
base-mounted	3-3
duct-ventilated	3-3
rack-mounted	3-3
side by side mounting	3-4
setting reference units	5-13
setting speeds in reference units	5-14
shock resistance	2-4, 3-2
/SO1 to /SO3	4-11

software limit	5-16, 6-5, 7-17
/S-ON	4-10, 5-5
SPD	6-5
specifications	2-1
/S-RDY	4-11, 5-9
start bits	7-2, 7-6
/START-STOP	4-12, 4-15, 6-3, 6-9, 6-11
status display	8-3
stop bits	7-2, 7-6
storage humidity	2-4
storage temperature	2-4
surrounding air temperature	2-4, 3-2

T

torque limit	5-19
troubleshooting	9-2
troubleshooting malfunction based on operation and conditions	9-19

U

UL standards	xiii, 3-2
utility function	7-31, 8-4, 10-28

V

vibration resistance	2-4, 3-2
vibration source	3-2

W

/WARN	4-11, 5-9
warning output	5-9
warnings	
list of warnings for SERVOPACKs	9-12
status displays	9-12
warning displays	9-12
wiring and connection	4-1

X

X-ON/X-OFF control	7-2
--------------------	-----

Z

ZONE	6-22, 7-29
ZONE signal	6-6, 6-22
ZONE table	6-6, 6-15, 6-22, 7-21
ZONE table edit	8-11
ZONE table initialization	8-17
ZONE table save	8-12
ZONE table setup commands	7-29

Revision History

The revision dates and numbers of the revised manuals are given on the bottom of the back cover.

MANUAL NO. SIEP C720829 02C

Published in Japan September 2010 09-7 \diamond -1

Date of publication
Date of original publication
Revision number
WEB revision number

Date of Publication	Rev. No.	WEB Rev. No.	Section	Revised Content
February 2012	\diamond 4	0	Front cover, 1.1, 1.3, 2.1	Deletion: RoHS mark
			5.4.1 (4)	Revision: Figure for average movement time filter
			6.5	Revision: Wave forms of /HOME and /DEC signals
			7.7.2	Revision: Wave forms of /DEC and encoder phase-C signals in Function/Description of ZRN serial command
			7.7.3	Addition: PRMB53 in Positive Response of PRMppp serial command
			7.7.8	Addition: Second note for IN1 serial command
			10.1, 10.6	Addition: Parameter PnB53
January 2012	\diamond 3	0	–	SIEP C720829 02C<2>-2, available on the Web.
			Back cover	Revision: Address
October 2010	\diamond 2	2	Front cover, back cover	Revision: Format
			2.3	Addition: Description of S1 and S2
			4.2.3	Deletion: Earth symbol of CN8
			9.2.1	Revision: Warning code output of A.A9F
			10.1	Revision: Factory setting of PnB23
			10.2	Revision: Description of Pn001.4
September 2010	\diamond 1	1	6.5	Addition: Restrictions on encoder use
			10.2	Revision: Descriptions of the first digit of Pn000
			Back cover	Revision: Address
June 2010	\diamond 0	0	All chapters	Addition: Information about the digital operator Revision: Slightly revised
			6.1.10 (8)	Addition: Information about the continuous stop function
			Chapter 8	Addition: Entire chapter on the digital operator
			–	–
December 2009	\diamond 1	–	All chapters	Addition: Linear servomotors
			2.1.2	Addition: Features of firmware versions
			Chapter 5	Addition: Parameter configuration – Fully-closed loop control parameters and linear servo-motor parameters
			5.2.2	Addition: Note
			5.2.7	Addition: Notes when the position completed state is established while canceling a motion command
			5.3.1(4)	Addition: Important
			5.3.6	Addition: Fully-closed loop control
			6.2.2 (1)	Revision: Connector pin number
			7.7.1	Addition: Serial command RES
			7.7.3	Revision: Positive response for PRMppp
			7.7.8	Revision: Positive responses for ALM, TRMS, RGRMS, and DBRMS Addition: Serial command IN3
July 2009	–	–	–	First edition

AC Servo Drives Σ -V Series USER'S MANUAL INDEXER Module

IRUMA BUSINESS CENTER (SOLUTION CENTER)

480, Kamifujisawa, Iruma, Saitama 358-8555, Japan
Phone 81-4-2962-5151 Fax 81-4-2962-6138

YASKAWA AMERICA, INC.

2121 Norman Drive South, Waukegan, IL 60085, U.S.A.
Phone (800) YASKAWA (800-927-5292) or 1-847-887-7000 Fax 1-847-887-7310

YASKAWA ELÉTRICO DO BRASIL LTDA.

Avenida Fagundes Filho, 620 São Paulo-SP CEP 04304-000, Brazil
Phone 55-11-3585-1100 Fax 55-11-5581-8795

YASKAWA EUROPE GmbH

Hauptstraße 185, Eschborn 65760, Germany
Phone 49-6196-569-300 Fax 49-6196-569-398

YASKAWA ELECTRIC UK LTD.

1 Hunt Hill Orchardton Woods Cumbernauld, G68 9LF, United Kingdom
Phone 44-1236-735000 Fax 44-1236-458182

YASKAWA ELECTRIC KOREA CORPORATION

9F, Kyobo Securities Bldg. 26-4, Yeouido-dong, Yeongdeungpo-gu, Seoul, 150-737, Korea
Phone 82-2-784-7844 Fax 82-2-784-8495

YASKAWA ELECTRIC (SINGAPORE) PTE. LTD.

151 Lorong Chuan, #04-01, New Tech Park 556741, Singapore
Phone 65-6282-3003 Fax 65-6289-3003

YASKAWA ELECTRIC (SHANGHAI) CO., LTD.

12F, Carlton Bld., No.21 HuangHe Road, HuangPu District, Shanghai 200003, China
Phone 86-21-5385-2200 Fax 86-21-5385-3299

YASKAWA ELECTRIC (SHANGHAI) CO., LTD. BEIJING OFFICE

Room 1011, Tower W3 Oriental Plaza, No.1 East Chang An Ave.,
Dong Cheng District, Beijing 100738, China
Phone 86-10-8518-4086 Fax 86-10-8518-4082

YASKAWA ELECTRIC TAIWAN CORPORATION

9F, 16, Nanking E. Rd., Sec. 3, Taipei 104, Taiwan
Phone 886-2-2502-5003 Fax 886-2-2505-1280



YASKAWA ELECTRIC CORPORATION

In the event that the end user of this product is to be the military and said product is to be employed in any weapons systems or the manufacture thereof, the export will fall under the relevant regulations as stipulated in the Foreign Exchange and Foreign Trade Regulations. Therefore, be sure to follow all procedures and submit all relevant documentation according to any and all rules, regulations and laws that may apply.

Specifications are subject to change without notice for ongoing product modifications and improvements.

© 2009-2012 YASKAWA ELECTRIC CORPORATION. All rights reserved.

MANUAL NO. SIEP C720829 02E

Published in Japan February 2012 09-7 -0

11-12-5

Original instructions